

Mundhöhlen Instrumentarium

Oral Cavity Instruments







Über uns

About Us

Herzlich willkommen in unserem Instrumentenkatalog.

Bevor Sie in die Welt unserer ‚MADE IN GERMANY‘ Instrumente eintauchen, möchten wir Ihnen einen kurzen Einblick in unsere Erfolgsgeschichte gewähren.

Was vor 30 Jahren als überschaubares Handelsunternehmen begann, hat sich seitdem zu einem weltweit etablierten Hersteller erstklassiger **HNO-Instrumente und Verbrauchsmaterialien** entwickelt.

Unsere Geschichte ist geprägt von einer tiefen Hingabe zur Hals-, Nasen- und Ohrenchirurgie sowie von kontinuierlicher Weiterentwicklung. **Unsere Leidenschaft** zur HNO spiegelt sich wider in der Partnerschaft mit den medizinischen Fachkräften, die ein integraler Bestandteil unseres Netzwerks und unserer Innovationskraft sind.

Einen weiteren Schlüssel unseres Erfolges stellen **unsere Mitarbeiter** dar, von denen einige bereits seit Jahrzehnten Teil unseres Unternehmens sind. Ihre Fachkompetenz und kontinuierlicher Einsatz haben es uns ermöglicht, zusammen mit Ihnen neue Produkte zu entwickeln und fortlaufend zu verbessern.

2020 ist die **SPIGGLE & THEIS Medizintechnik GmbH** mehrheitlich von der **Thyssen'schen Handelsgesellschaft** übernommen worden, wodurch der weitere Ausbau des Unternehmens, unter Berücksichtigung unserer Innovationskraft und des Qualitätsversprechens, sichergestellt ist. Mit diesem starken Partner an unserer Seite eröffnen sich neue Horizonte, die uns unsere Visionen schneller umsetzen lassen und den Kundenanforderungen noch besser gerecht werden.

Dieser Katalog präsentiert **hochwertige Instrumente**, die auf den Bedürfnissen unserer Kunden und Partner aus der HNO-Medizin basieren. Wir hoffen, dass Sie unser Produktportfolio überzeugt und Sie hier das passende Instrument für Ihre Anforderung finden.

Wir danken Ihnen herzlich für Ihre **Treue** und Ihr **Vertrauen**.

Ihr SPIGGLE & THEIS Team

Welcome to our instrument catalog.

Before you immerse yourself in the world of our ‚MADE IN GERMANY‘ instruments, allow us to offer a brief glimpse into our success story.

What began as a modest trading company three decades ago has since developed into a globally recognized manufacturer of top-tier **ENT instruments and consumables**.

Our history is defined by a profound dedication to ENT surgery, healing practices, and continuous growth. **Our passion** resonates perfectly with the physicians, specialists, and medical professionals who are integral to our network and innovative spirit.

Another vital aspect of our success is **our employees**, some of whom have been with our company for decades. Their expertise and unwavering dedication have empowered us to collaborate with you in developing and consistently enhancing new products.

In 2020, **SPIGGLE & THEIS Medizintechnik GmbH** was primarily acquired by **Thyssen'sche Handelsgesellschaft**, ensuring the company's continued expansion while prioritizing our innovative capacity and commitment to quality. With this robust partnership at our side, new horizons have emerged, accelerating the realization of our visions and enhancing our ability to meet customer demands more efficiently.

This catalog showcases **premium instruments** tailored to the needs of our clients and partners in the field of ENT medicine. We hope you discover the perfect instrument that meets your requirements and allows our commitment to quality to speak for itself.

Thank you very much for your **loyalty** and **trust**.

Your SPIGGLE & THEIS Team



Inhaltsverzeichnis

Table of contents

01	Endoskopie / Endoscopy.....	5 - 9
02	Adenotomie / Adenotomy.....	10 - 12
03	Tonsillektomie / Tonsillectomy	13 - 30
04	Kehlkopf / Larynx	31 - 35
05	Speichelgang / Salivary Duct.....	36 - 37
06	Koagulation / Coagulation	38 - 48
07	Tracheotomie / Weichteile / Allgemeines Tracheotomy / Neck Dissection / Miscellaneous	49 - 63
08	Sets	64 - 72
	Index.....	74 - 77

Attention:

Not every instrument is available in all markets. Availability depends on local regulations. Please contact your SPIGGLE & THEIS representative or distributor, if you have any questions about the availability of our products in your region.

Arbeitslänge	32 cm
Working length	32 cm
Abwinkelung (auf / ab)	130°
Angle (up / down)	130°
Biegeradius	8 mm
Bending radius	8 mm
Tiefenschärfe	5-50 mm
Depth of focus	5-50 mm
Gewicht	260 g
Weight	260 g
inkl. Dichtigkeitstester	
incl. leak tester	



Art.-Nr.	Blickfeld	
Art.-No.	Field of vision	
130 400 028ST	100°	2,8 mm / 2.8 mm
130 400 034ST	80°	3,4 mm / 3.4 mm
130 414 040ST	80°	Ø 4 mm mit Arbeitskanal, Ø 1,4 mm Ø 4 mm with working channel, Ø 1.4 mm

Unsere Nasopharyngoskope der neuesten Generation sind intuitiv bedienbar und ergonomisch optimiert. Sie wurden für die notwendige Feinfühligkeit im täglichen Routineeinsatz und für eine ermüdungsfreie Handhabung entwickelt.

Hochwertige Bildleiter und ein leistungsfähiges optisches System liefern große und helle Bilder in bester Auflösung - die Voraussetzung für eine sichere Diagnose und Therapie. Dank solider Verarbeitung und konsequenter Verwendung moderner Hochleistungswerkstoffe sind unsere Nasopharyngoskope äußerst robust und langlebig - trotz steigender Belastung durch moderne Aufbereitungsverfahren.

Our newest generation nasopharyngoscopes impresses with intuitive operability and optimal ergonomics, designed for tactile sensation and non-tiring handling as required in daily routine operations.

High-end fibre-optic bundles and a high-capacity system produce large and bright images of the best quality - necessary for safe diagnosis and treatment. Due to the consistent use and reliable processing of high-class materials, our nasopharyngoscopes are robust and durable, in spite of the increasing stress of modern cleaning and sterilizing facilities.

Vorteile unserer Endoskope:

- Funktionelles Design für eine einfache und komfortable Handhabung
- Feinfühlig, aber robuste Steuerung
- Optimale Flexibilität und Torsionssteifigkeit des Einführungsschafts
- Leistungsfähiges optisches System: größere, hellere und schärfere Bilder

Geeignete Wiederaufbereitungsverfahren:

- Einlegbar in Reinigungs- und Desinfektionslösung
- NTDF-Sterilisation = Niedertemperatur-Dampf-Formaldehyd-Sterilisation
- Maschinelle Aufbereitung (RDG-E)

Advantages of our endoscopes:

- Functional design for easy and comfortable handling
- Sensitive yet robust control
- Optimal flexibility and torsional rigidity of the insertion channel
- High-performance optical system for larger, brighter and sharper images

Suitable reprocessing procedures:

- Fully immersible in cleaning and disinfectant solutions
- LTSF-sterilization = Low-Temperature Steam and Formaldehyde sterilization
- Machine reprocessing (RDG-E)





Flexible Biopsiezange, Ø 1 mm, 120 cm, ovaler Löffel, für flexibles Endoskop 130 414 040ST

Flexible biopsy forceps, Ø 1 mm, oval cups, for flexible endoscope 130 414 040ST

30-172-40

Flexible Alligator-Fasszange, Ø 1 mm, 120 cm, gezahntes Maul, für flexibles Endoskop 130 414 040ST

Flexible alligator forceps, Ø 1 mm, 120 cm, serrated jaws, for flexible endoscope 130 414 040ST

30-173-40



Reinigungsbürste mit Grifföse, AL 40 cm, Bürste Ø 2,0 mm, Besatzlänge 10 mm, für Arbeitskanal bis 1,5 mm, 10 Stück / Box, Einweg

Cleaning brush with loop, WL 40 cm, brush Ø 2.0 mm, length of edging 10 mm, for working channels up to 1.5 mm, 10 pieces/ box, single use

30-175-40



Ultra-Stop Antibeschlagmittel / Ultra-Stop Anti-Fog solution

Art.-Nr./No.	Beschreibung / Description
30-160-01	25 ml Pipettenflasche, unsteril 25 ml pipette bottle, non-sterile
30-160-02	30 ml Durchstichflasche, steril 30 ml pierce bottle, sterile
30-160-03	15 ml Sprayflasche, unsteril 15 ml spray bottle, non-sterile



Sterilisations-Container für Endoskope

Ø 2,5 - 5,0 mm, bis 19,5 cm Länge

Sterilizing and protecting tray for endoscopes

Ø 2.5 - 5.0 mm, up to 19.5 cm length

Art.-Nr./No.	Beschreibung / Description
80-621-05	für 2 Endoskope / for 2 endoscopes
80-622-56	für 6 Endoskope, 1 Lichtkabel for 6 endoscopes, 1 light-cable
80-623-22	für 2 Endoskope, 1 Lichtkabel, 1 Kamerakopf for 2 endoscopes, 1 light-cable, 1 camera head



Endoskopie-Siebkorb mit Deckel, Edelstahl, elektroliert

Endoscope container with lid, stainless steel, e-polished

Art.-Nr./No.	Größe / Size (cm)
80-691-01	46 x 8 x 5,2 für 1 Endoskop 46 x 8 x 5.2 for 1 endoscope
80-692-01	67 x 8 x 5,2 für 1 Endoskop 67 x 8 x 5.2 for 1 endoscope

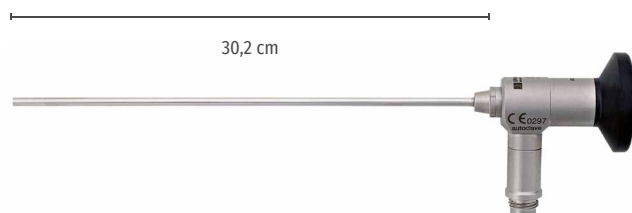

Laryngoskop, HD, autoklavierbar, 30,2 cm

Laryngoscope, HD, autoclavable, 30.2 cm

Art.-Nr. Art.-No.	Größe Size (mm)	Winkel Angle	
40-110-00	4,0	0°	○
40-110-30	4,0	30°	○
40-110-70	4,0	70°	○
40-112-00	4,0	0°	○
40-112-30	2,7	30°	○
40-112-70	2,7	70°	○



Mikro-Laryngoskop, 70°, HD, autoklavierbar

Micro-Laryngoscope, 70°, HD, autoclavable

40-111-70



Anti-Fog Antibeschlag-Satz, steril, 48 Stück/Box
Anti-Fog Solution Kit, sterile, 48 pieces/box

30-160-05



LED-Leuchtgriffe / LED light handles

Art.-Nr./No.

70-211-00 LED-Hochleistungs-Leuchtgriff, 230 V, bestehend aus: (70-211-10, 70-211-20, 70-211-30, 70-211-40)
 LED high performance light-handle, 230 V, consisting of: (70-211-10, 70-211-20, 70-211-30, 70-211-40)

70-211-01 LED-Hochleistungs-Leuchtgriff, 120 V, bestehend aus: (70-211-10, 70-211-20, 70-211-30, 70-211-50)
 LED high performance light-handle, 120 V, consisting of: (70-211-10, 70-211-20, 70-211-30, 70-211-50)

70-211-10 LED-Handgriff, schwarz, mit Helligkeitsdimmer, Ausschaltautomatik, 3 W, 5500 °K, 17500 Lux, zur Verwendung mit Li-Io-Akku 3,7 V und Endoskop-Adapter, 50 Std. Brenndauer
 LED light handle, black, with brightness dimmer, automatic switch-off, 3 W, 5500 °K, 17500 lux, to use with Li-ion chargeable battery 3.7 V and endoscope adapter, 50 hours run-time

70-211-20 Li-Ionen-Akku, 3,7 V, für LED-Handgriff
 Li-ion rechargeable battery, 3.7 V, for LED light-handle

70-211-30 Endoskopie-Adapter für LED-Handgriff, passend für Standardgewinde an Endoskopen (AcMI-Gewinde)
 Endoscope adapter for LED light-handle, fits standard endoscope threads (AcMi-thread)

70-211-40 Ladegerät für bis zu 2 LED-Handgriffe, 3,5 V, 230 V, Standgerät, mit Wandhalterung
 Charging base for up to 2 LED light-handles, 3.5 V, 230 V, table model, with wall holder

70-211-50 Ladegerät für bis zu 2 LED-Handgriffe, 3,5 V, 120 V, Standgerät, Wandhalterung
 Charging base for up to 2 LED light-handles, 3.5 V, 120 V, table model, with wall holder

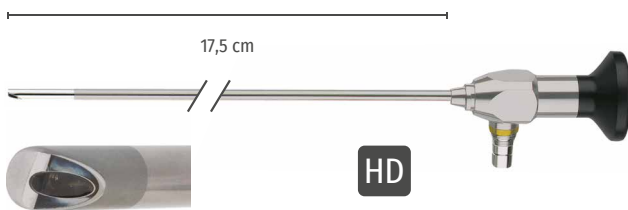

Laryngoskop, HD, autoklavierbar, 17,5 cm

Laryngoscope, HD, autoclavable, 17.5 cm

Art.-Nr. Art.-No.	AD OD (mm)	Winkel Angle	
40-100-70	4	70°	<input type="radio"/>
40-100-90	4	90°	<input type="radio"/>



Laryngoskop, HD, autoklavierbar, Handgriff, 19 cm

Laryngoscope, HD, autoclavable, handle, 19 cm

Art.-Nr. Art.-No.	AD OD (mm)	Winkel Angle	
40-103-70	10	70°	<input type="radio"/>
40-103-90	10	90°	<input type="radio"/>

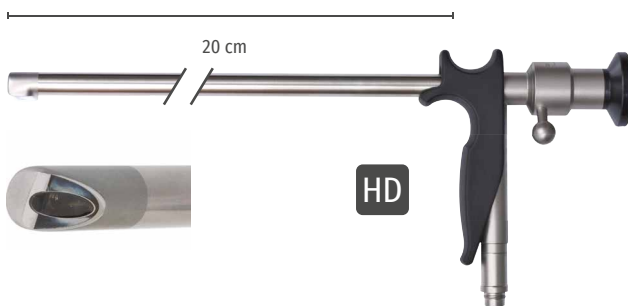

Zoom Laryngoskop, HD, einlegbar, Handgriff, 20 cm

Zoom laryngoscope, HD, soakable, handle, 20 cm

Art.-Nr. Art.-No.	AD OD (mm)	Winkel Angle	
40-105-70	10	70°	<input type="radio"/>
40-105-90	10	90°	<input type="radio"/>



Laryngoskop, HD, autoklavierbar, Handgriff, 19,8 cm

Laryngoscope, HD, autoclavable, handle, 19.8 cm

Art.-Nr. Art.-No.	AD OD (mm)	Winkel Angle	
40-107-70	8	70°	<input type="radio"/>



02 Adenotomie

Adenotomy

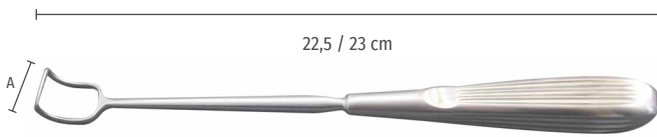

Beckmann Ringmesser, gerade
Beckmann adenoid curette, straight

Art.-Nr. Art.-No.	Größe Size	Länge A Length A (mm)	Länge Length (cm)
40-201-00	0	10,5	22,5
40-201-01	1	12,2	22,5
40-201-02	2	14,3	22,5
40-201-03	3	15,4	22,5
40-201-04	4	17,5	23,0



Negus Ringmesser, vorwärts gebogen, 22 cm
Negus adenoid curette, curved forwards, 22 cm

Art.-Nr. Art.-No.	Größe Size	Länge A Length A (mm)
40-203-00	0	10,2
40-203-01	1	12,2
40-203-02	2	14,3
40-203-03	3	15,4
40-203-04	4	17,5



Stubbs Ringmesser, rückwärts gebogen, 22 cm
Stubbs adenoid curette, curved backwards, 22 cm

Art.-Nr. Art.-No.	Größe Size	Länge A Length A (mm)
40-206-00	0	10,0
40-206-01	1	12,0
40-206-02	2	16,0
40-206-03	3	18,0



Vogel Ringmesser, gerade, 22,5 cm
Vogel adenoid curette, straight, 22.5 cm

Art.-Nr./No.	Länge A / Length A (mm)
40-211-08	8,0



Jatho Nasenrachenzange, 70° aufgebogen, Rohrschaft, AL 15 cm
Jatho epipharyngeal forceps, 70° upcurved, tubular model, WL 15 cm

Art.-Nr./No.	Beschreibung / Description
40-220-01	vertikal öffnend / opens vertically
40-220-02	horizontal öffnend / opens horizontally



Jurasz Nasenrachenzange, 19 cm
Jurasz adenoid forceps, 19 cm

40-225-00



Hartmann Conchotom, rund, 12 cm
Hartmann cutting forceps, round, 12 cm

Art.-Nr./No.	Größe / Size	Größe / Size (mm)
--------------	--------------	-------------------

20-252-01

1

7



20-252-02

2

8



20-252-03

3

9



20-252-04

4

10



02 Adenotomie

Adenotomy



Schmeden Conchotom, dreieckig, 12 cm
Schmeden cutting forceps, triangular, 12 cm

Art.-Nr./No.	Größe / Size	Größe / Size (mm)	
20-254-00	0	6	
20-254-01	1	7	
20-254-02	2	8	
20-254-03	3	12	



Nager Gaumensegelhaken, 22 cm / Nager pillar retractor, 22 cm
40-230-21



Hofer Gaumenbogenhaken, 22 cm / Hofer palate retractor, 22 cm
40-232-23



Kabierske Pulverbläser, komplett mit drei Kanülen für Ohr, Nase, Rachen und Hals, mit Glas und Ventilball
Kabierske powder blower, set with three cannulae for ear, nose, pharynx and larynx, bottle and rubber ball

Art.-Nr./No.	Beschreibung / Description
10-155-00	Pulverbläser komplett / powder blower, set
10-155-01	Ersatzglas / spare bottle
10-155-02	Gummiball / rubber ball



Davis-Meyer Mundsperrer, verstellbare Zahnhaken

Davis-Meyer mouth gag, adjustable tooth hooks

Art.-Nr./No.	Beschreibung / Description
40-300-01	rechts offen / right side open
40-300-02	links offen / left side open



Davis-Boyle Mundsperrer / Davis-Boyle mouth gag

Art.-Nr./No.	Beschreibung / Description
40-302-01	rechts offen / right side open
40-302-02	links offen / left side open
40-302-03	rechts offen für Kinder right side open for children
40-302-04	links offen für Kinder left side open for children



Silikonschützer für Davis-Boyle Mundsperrer, 1 Stück

Silicone insert for Davis-Boyle mouth gags, 1 piece

40-303-00



Mclvor Mundsperrer / Mclvor mouth gag

Art.-Nr./No.	Beschreibung / Description
40-305-01	klein, geschlossen / small closed form



Silikonformschlauch, geschlitzt, für Mclvor Mundsperrer, wiederverwendbar, 5 Stück

Silicone tubing, slit, for Mclvor mouth gag, reuseable, 5 pieces

40-305-99



03 Tonsillektomie

Tonsillectomy



Mclvor Zungenspatel, glatt / Mclvor tongue depressor, smooth

Art.-Nr. Art.-No.	Größe Size	Größe Size (mm)
40-310-01	1	23,0 x 75,0
40-310-02	2	25,0 x 91,0
40-310-03	3	26,0 x 103,0



**Davis-Boyle Zungenspatel, mit beidseitigem Absaugrohr
Davis-Boyle tongue depressor, double sided suction tubes**

Art.-Nr. Art.-No.	Größe Size	Größe Size (mm)
40-311-01	1	29,0 x 65,0
40-311-15	1½	29,0 x 70,0
40-311-02	2	30,5 x 75,0
40-311-25	2½	31,5 x 80,0
40-311-03	3	32,5 x 85,0
40-311-35	3½	33,5 x 95,0
40-311-04	4	34,0 x 105,0



Davis-Boyle Zungenspatel / Davis-Boyle tongue depressor

Art.-Nr. Art.-No.	Größe Size	Größe Size (mm)	Beschreibung Description
40-312-01	1	20,0 x 35,0	glatt / smooth
40-312-02	2	23,0 x 70,0	gerieft / serrated
40-312-03	3	24,0 x 85,0	gerieft / serrated
40-312-04	4	25,0 x 95,0	gerieft / serrated
40-312-05	5	26,0 x 110,0	gerieft / serrated
40-313-01	1	17,0 x 35,0	glatt für Kinder smooth for children
40-313-02	2	19,0 x 51,0	gerieft für Kinder serrated for children
40-313-03	3	20,0 x 60,0	gerieft für Kinder serrated for children
40-313-04	4	22,0 x 75,0	gerieft für Kinder serrated for children
40-313-05	5	22,0 x 84,0	gerieft für Kinder serrated for children



Russel-Davis Zungenspatel mit Rinne

Russel-Davis tongue depressor with central channel

Art.-Nr./No.	Größe / Size	Dimension / Dimension (mm)
40-315-01	1	30 x 70
40-315-02	2	34 x 80
40-315-03	3	39 x 85
40-315-04	4	42 x 98
40-315-05	5	46 x 107



Russel-Davis Zungenspatel mit Rinne, Ausgang links

Russel-Davis tongue depressor with central channel, outlet left side

Art.-Nr./No.	Größe / Size	Dimension / Dimension (mm)
40-318-01	1	30 x 70
40-318-02	2	34 x 80
40-318-03	3	39 x 85
40-318-04	4	42 x 98
40-318-05	5	46 x 107

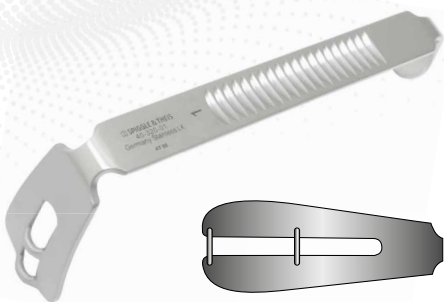

Zungenspatel, Würzburger Modell

Tongue depressor, Würzburg model

Art.-Nr./No.	Größe / Size	Dimension / Dimension (mm)
40-320-01	1	28 x 69
40-320-03	3	34 x 85



03 Tonsillektomie

Tonsillectomy



Ring Zungenspatel / Ring tongue depressor

Art.-Nr. Art.-No.	Größe Size	Größe Size (mm)	Beschreibung Description
40-322-02	2	24 x 65	links / left
40-322-03	3	27 x 72	links / left
40-322-04	4	34 x 91	links / left
40-322-05	5	37 x 95	links / left
40-323-02	2	25 x 65	rechts / right



Dingmann Mundsperrer, Rahmen mit 2 Wangenhaltern, 2 Zahnhaken und 2 Fadenführern

Dingmann mouth gag, frame with 2 cheek retractors,
2 tooth hooks and 2 thread guides

40-327-00

Dingmann Zahnhaken, verstellbar, 2 Stück

Dingmann tooth hooks, adjustable, 2 pieces

40-327-99



Negus Bruststütze, mit Halteband
Negus chest support, with band

Art.-Nr. Art.-No.	Größe Size (cm)	Beschreibung Description
40-330-14	14,0	für Erwachsene / for adults
40-330-09	8,5	für Kinder / for children



Draffin Mundsperrer-Aufhängung
Draffin bipod suspension for mouth gags

Art.-Nr./No.	Beschreibung / Description
40-335-01	für Kinder / for children
40-335-99	Magauran-Platte / Magauran plate



Narkosebügel, L-Form, zur Aufhängung von Mundsperrern
Anesthesia frame L-form, for suspending mouth gags

40-337-00



Gelenkkloben zur Befestigung am OP-Tisch, passend für flexiblen Spannarm 30-700-00 und Narkosebügel 40-337-00

Rotation clamp for fixation to operating table, compatible with flexible holding arm 30-700-00 and anesthesia frame 40-337-00

30-700-01



Jennings Mundsperrer / Jennings mouth gag

Art.-Nr./No.	Länge / Length (cm)
40-340-09	9,5
40-340-11	11,5
40-340-13	13,5
40-340-15	14,5

03 Tonsillektomie

Tonsillectomy

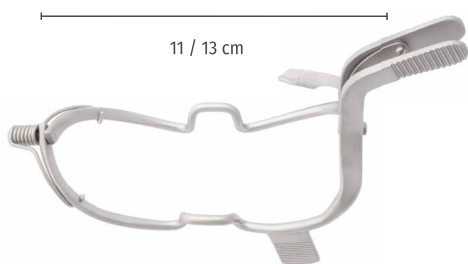

Seemann-Seiffert Mundsperrer, Standard-Modell, selbsttätig nachspreizend

Seemann-Seiffert mouth gag, basic model, self retaining

Art.-Nr./No.	Länge / Length (cm)
40-341-11	11
40-341-13	13

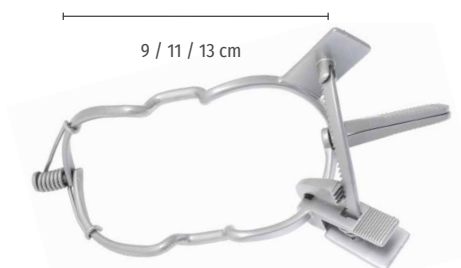

Seemann-Seiffert Mundsperrer, selbsttätig nachspreizend

Seemann-Seiffert mouth gag, self retaining

Art.-Nr./No.	Länge / Length (cm)
40-342-09	9
40-342-11	11
40-342-13	13



Sluder-Ballenger Tonsillotom, Simal-Ausführung, Handgriff

Sluder-Ballenger tonsillotome, simal model, handle

40-350-10



Sluder-Ballenger Tonsillotom Spatel, Simal-Ausführung

Sluder-Ballenger tonsillotome blade, simal model

Art.-Nr./No.	Größe / Size
40-350-01	1
40-350-02	2
40-350-03	3

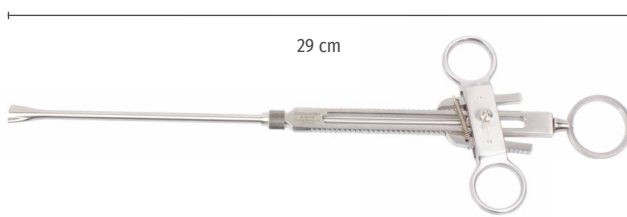

Brünings Tonsillenschnürer, 29 cm / Brünings tonsil snare, 29 cm

40-355-28



Eves Tonsillenschnürer, 28,5 cm / Eves tonsil snare, 28.5 cm

40-357-28

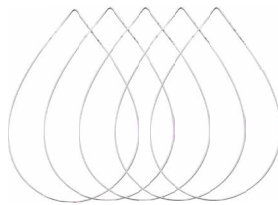

Tonsillen-Schlingen für Brünings Tonsillenschnürer, Edelstahl, geschlossen, 100 Stück / Box

Tonsil wire loops for Brünings tonsil snare, stainless steel, closed, 100 pieces / box

Art.-Nr./No.	Größe / Size
40-360-40	0,4 x 40
40-360-50	0,4 x 50



Tonsillenschlingen, für Eves Tonsillenschnürer, rostfrei, offen, 0,45 mm, 100 Stück/Box

Tonsil loops for Eves tonsil snare, stainless, 0.45 mm, 100 pieces

40-361-45

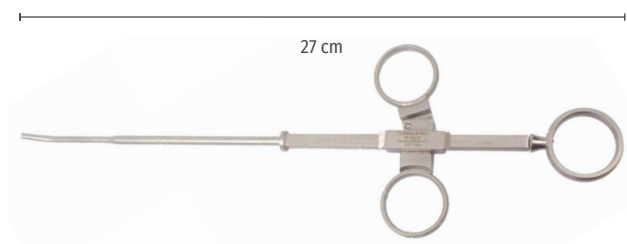

Roeder Ligatur-Instrument, Form E, für Vicryl-Faden, 27 cm

Roeder ligature instrument, form E, for vicryl wire, 27 cm

40-359-27



Drahtbiede- und Schneideschere, Hartmetall, gezahnt, gewinkelt, 12 cm

Wire bending and cutting scissors, tungsten carbide, with teeth, angled, 12 cm

10-745-12

03 Tonsillektomie

Tonsillectomy



Hurd Unterbindungsnadel, 22 cm
Hurd tonsil suture needle, 22 cm

Art.-Nr./No.	Beschreibung / Description
40-365-01	rechts gebogen / right curved
40-365-02	links gebogen / left curved



Nager Unterbindungsnadel, gerade, 23,5 cm
Nager tonsil suture needle, straight, 23.5 cm

40-367-24



Fadenhäkchen, spitz, rund, 90°, 20 cm
Suture hook, pointed, round, 90°, 20 cm

40-368-21



Fadenhäkchen, stumpf, flach, 90°, 20 cm
Suture hook, blunt, flat, 90°, 20 cm

40-369-21



Knotenführer, gabelförmig, stumpf, 20,5 cm
Knot tier, forked, blunt, 20.5 cm

40-370-21



Henke Raspatorium, doppelseitig, schmal/breit, 24 cm
Henke raspatory, double ended, slender/wide, 24 cm

40-382-24



Henke Raspatorium/Dissektor / Henke raspatory/dissector

Art.-Nr. Art.-No.	Größe Size (mm)	Länge Length (cm)	Beschreibung Description
40-381-12	12	23,5	schmal / slender
40-381-15	15	24,0	breit / wide



Hurd Raspatorium/Retraktor, 9 mm/14,5 mm, 22,5 cm
Hurd raspatory/retractor, 9 mm/14.5 mm, 22.5 cm

40-384-23



Hurd Elevatorium/Retraktor, gefenstert, 11,5 mm, 23 cm
Hurd elevator/retractor, fenestrated, 11.5 mm, 23 cm

40-386-23



Raspatorium Würzburger Modell,
eine Seite gezahnt, eine Seite Lanzett, 10 mm, 21,5 cm
Raspatory Würzburg type,
one side serrated, one side lancet, 10 mm, 21.5 cm

40-388-21



03 Tonsillektomie

Tonsillectomy

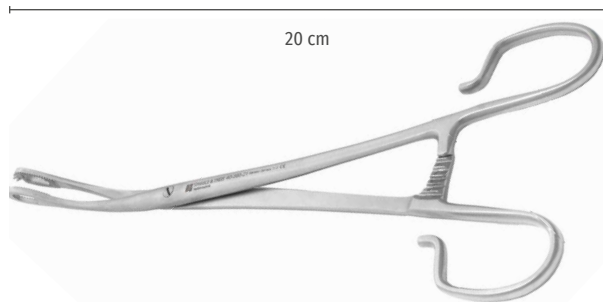

Blohmke Fasszange, gebogen, 20 cm
Blohmke tonsil forceps, curved, 20 cm

40-390-21



Colver Fasszange, gebogen, 19 cm
Colver tonsil forceps, curved, 19 cm

40-392-19



White Fasszange, gebogen / White tonsil forceps, curved

Art.-Nr./No.	Länge / Length (cm)
40-394-18	18
40-394-23	23

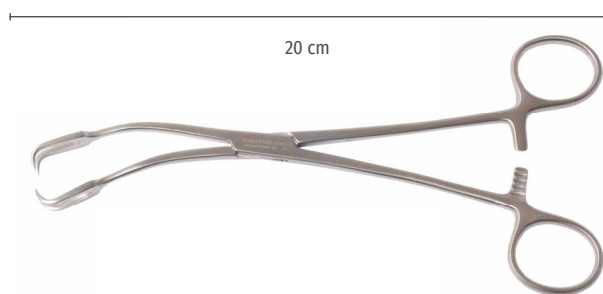

Ballenger Fasszange, gebogen, 2:2 Zähne, 20 cm
Ballenger tonsil forceps, curved, 2:2 teeth, 20 cm

40-395-22

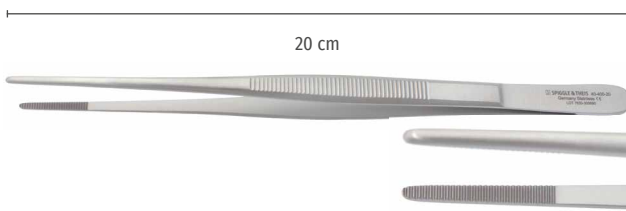

Tonsillen-Pinzette, gerieft, fein, 2,2 mm, 20 cm
Tonsil dressing forceps, serrated, fine, 2.2 mm, 20 cm

40-400-20

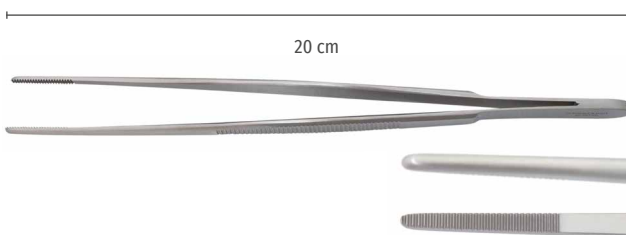

Tonsillen-Pinzette, gerieft, breit, 3,5 mm, 20 cm
Tonsil dressing forceps, serrated, wide, 3.5 mm, 20 cm

40-401-20

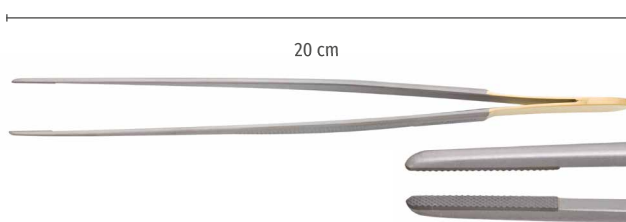

Tonsillen-Pinzette, gerieft, Hartmetall, 2 mm, 20 cm
Tonsil dressing forceps, serrated, tungsten carbide, 2 mm, 20 cm

40-402-20



Tonsillen-Pinzette, 1:2 Zähne, fein, 2 mm, 20,5 cm
Tonsil dissecting forceps, 1:2 teeth, fine, 2 mm, 20.5 cm

40-405-20



Tonsillen-Pinzette, breit, 20,5 cm
Tonsil dissecting forceps, wide, 20.5 cm

Art.-Nr./No.	Größe / Size (mm)	Zähne / Teeth
40-406-20	2,5	1:2
40-407-20	3,5	2:3
40-408-20	4,5	3:4



03 Tonsillektomie

Tonsillectomy

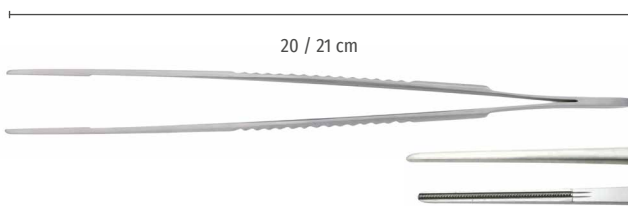

DeBaakey Pinzette, atraumatisch
DeBaakey dressing forceps, atraumatic

Art.-Nr./No.	Länge / Length (cm)	Größe / Size (mm)
40-410-20	21	2,7
40-412-20	20	2,0



Yankauer Saugrohr, abschraubbarer Ansatz
Yankauer Suction tube, detachable tip

Art.-No.	Länge Length (cm)	Öffnung Opening (mm)	Ø
40-420-29 für Erwachsene for adults	28,5	3,0	6,0
40-421-21 Für Kinder for children	21,5	2,0	5,0



Abschraubbarer Ansatz, Ersatzteil für 40-420-29
Detachable attachment, spare part for 40-420-29

40-420-99



Saugrohr, gerade, biegsam, konisch, 3,0 mm, 19,5 cm
Suction tube, straight, bendable, conical, 3.0 mm, 19.5 cm

10-303-18



Good-Schweckendiek Tonsillenschere, gebogen, gezahnt, 19 cm
Good-Schweckendiek tonsil scissors, curved, serrated, 19 cm

40-430-19



Good Tonsillenschere, gebogen, glatt, 19,5 cm
Good tonsil scissors, curved, smooth, 19.5 cm

40-431-19

03 Tonsillektomie

Tonsillectomy



Boettcher Tonsillenschere, gebogen, 18,5 cm

Boettcher tonsil scissors, curved, 18.5 cm

Art.-Nr./No.	Beschreibung / Description
40-433-18	stumpf / blunt
40-434-18	spitz / pointed

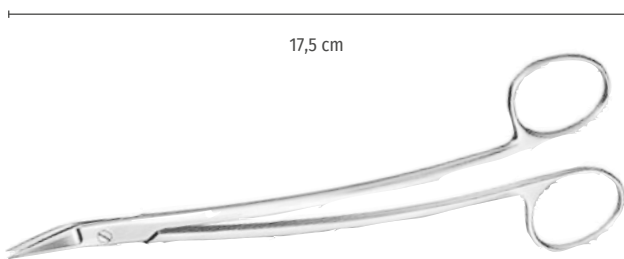

Dean Tonsillenschere, doppelt gebogen, gezahnt, spitz, 17,5 cm

Dean tonsil scissors, double curved, serrated, pointed, 17.5 cm

40-436-17

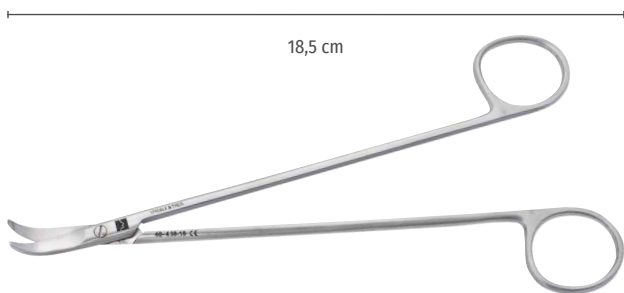

Muck Tonsillenschere, stark gebogen, 18,5 cm

Muck tonsil scissors, strongly curved, 18.5 cm

40-438-18

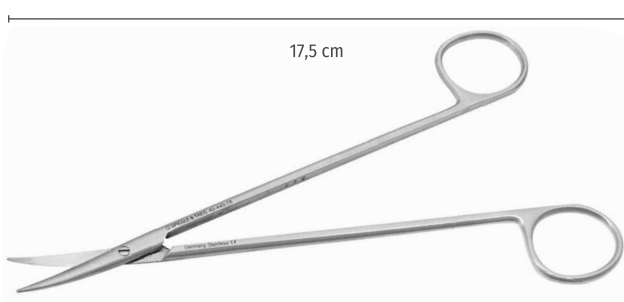

Toennis-Adson Tonsillenschere, gebogen, stumpf, extra fein, 17,5 cm

Toennis-Adson tonsil scissors, curved, blunt, very fine, 17.5 cm

40-440-18



03 Tonsillektomie

Tonsillectomy



Toennis-Adson Tonsillenschere, supercut, gebogen, stumpf, extra fein, 17,5 cm

Toennis-Adson tonsil scissors, supercut, curved, blunt, very fine, 17.5 cm

40-441-18



Toennis-Adson Tonsillenschere, Hartmetall, supercut, gebogen, stumpf, extra fein, 17,5 cm

Toennis-Adson tonsil scissors, tungsten carbide, supercut, curved, blunt, very fine, 17.5 cm

40-442-18



Metzenbaum Schere, stumpf-stumpf

Metzenbaum scissors, blunt

Art.-No.	Länge	Beschreibung
Art.-No.	Length (cm)	Description
20-612-18	18,0	gerade / straight
20-612-20	20,0	gerade / straight
20-614-18	18,0	gebogen / curved
20-614-20	20,5	gebogen / curved



Metzenbaum Schere, Hartmetall, stumpf-stumpf, fein

Metzenbaum scissors, tungsten carbide, blunt, fine

Art.-No.	Länge	Beschreibung
Art.-No.	Length (cm)	Description
20-613-18	18,0	gerade / straight
20-613-20	20,5	gerade / straight
20-615-18	18,0	gebogen / curved
20-615-20	20,5	gebogen / curved

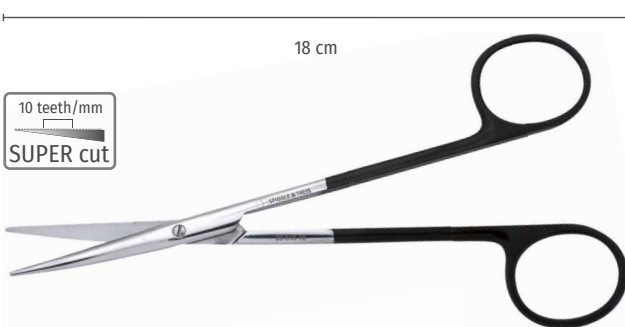

Metzenbaum Schere, supercut, gebogen, stumpf-stumpf, fein, 18 cm

20-616-18

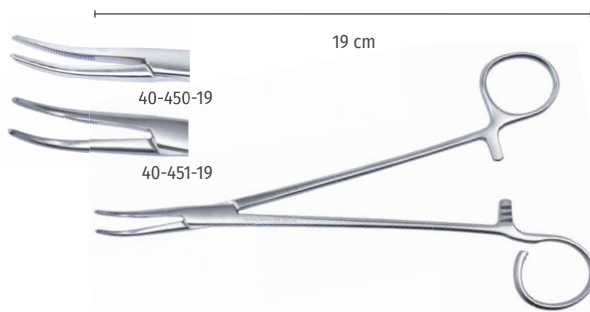

Schnidt Tonsillenklemme, einseitig offener Ring, schlank, 19 cm
Schnidt tonsil forceps, one ring open, slender, 19 cm

Art.-Nr./No.	Beschreibung / Description
40-450-19	leicht gebogen / slightly curved
40-451-19	stark gebogen / strongly curved

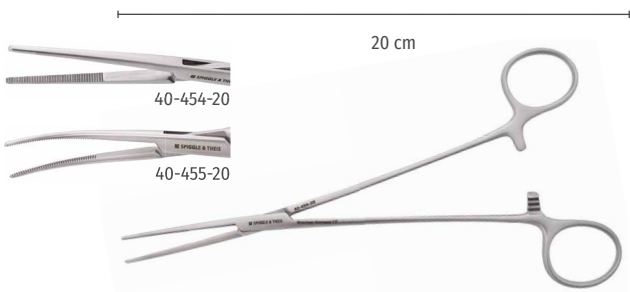

Birkett Tonsillenklemme, schlank, 20 cm
Birkett tonsil forceps, slender, 20 cm

Art.-Nr./No.	Beschreibung / Description
40-454-20	gerade / straight
40-455-20	gebogen / curved

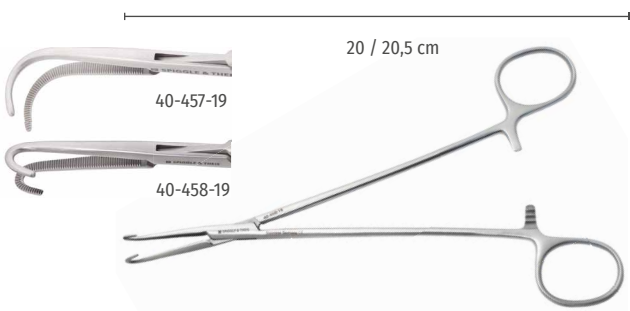

Negus Tonsillenklemme, schlank / Negus tonsil forceps, slender

Art.-No.	Länge Length (cm)	Beschreibung Description
40-457-19	20,0	stark gebogen wide curved
40-458-19	20,5	enger Bogen narrow curve



Overholt-Geissdoerfer Tonsillenklemme, gebogen, 19 cm
Overholt-Geissdoerfer tonsil forceps, curved, 19 cm

40-460-19



03 Tonsillektomie

Tonsillectomy



Mikulicz Tonsillenklemme, gebogen, 1:2 Zähne, 18,5 cm
Mikulicz tonsil forceps, curved, 1:2 teeth, 18.5 cm

40-462-18



Stream Line Mikro-Nadelhalter gerade, diamantiert, runde Federgriffe, Hochgl., Sperre, vergold., Maul 0,8mm, 18cm
Stream Line micro needle holder, straight, diamond tip, round type handles, golden, with ratchet, tip 0.8 mm, 18 cm

20-889-18

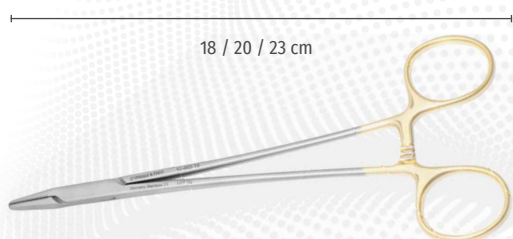

Crile-Wood Nadelhalter, Hartmetall, schlank
Crile-Wood needle holder, tungsten carbide, slender

Art.-Nr./No.	Länge / Length (cm)
40-465-18	18
40-465-20	20
40-465-23	23

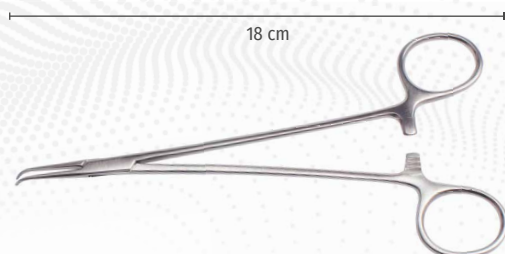

Klemme, Typ Augsburg, sehr fein, gebogen, 18 cm
Artery forceps, type Augsburg, very fine, curved, 18 cm

80-381-18

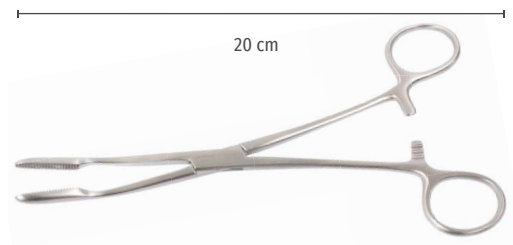

Gross Kornzange, gebogen, 20 cm
Gross sponge forceps, curved, 20 cm

40-474-20

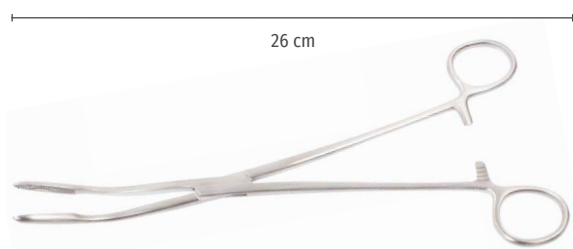

Gross-Maier Kornzange, gebogen, 26 cm
Gross-Maier sponge forceps, curved, 26 cm

40-475-26



Abraham Tonsillennmesser, spitz, gebogen, 22 cm
Abraham tonsil knife, pointed, curved, 22 cm

40-480-22

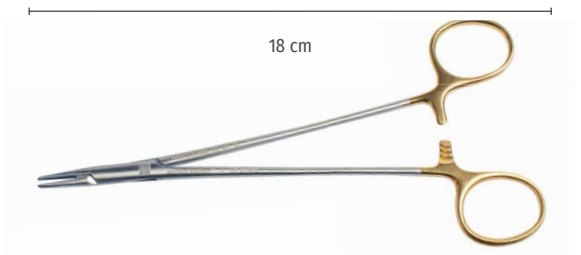

DeBakey Nadelhalter, Hartmetall, 18 cm
DeBakey needle holder, tungsten carbide, 18 cm

40-481-18



Brünings Tonsillennmesser, spitz, gebogen, 22 cm
Brünings tonsil knife, pointed, curved, 22 cm

40-482-23



Colver-Fischer Tonsillennmesser, gewinkelt, gezahnt, 22 cm
Colver-Fischer tonsil knife, angled, serrated, 22 cm

40-484-22

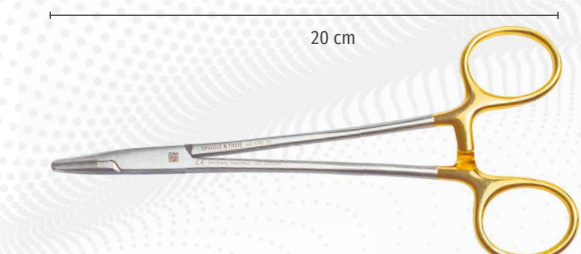

Mayo-Hegar Nadelhalter, Hartmetall,
Mayo-Hegar needle holder, tungsten carbide

Art.-Nr. Art.-No.	Länge Length (cm)
40-490-16	16
40-490-18	18

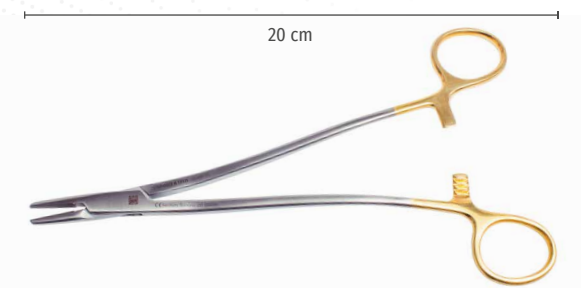

Bozemann Nadelhalter, Hartmetall, 20 cm
Bozemann needle holder, tungsten carbide, 22 cm

40-491-20

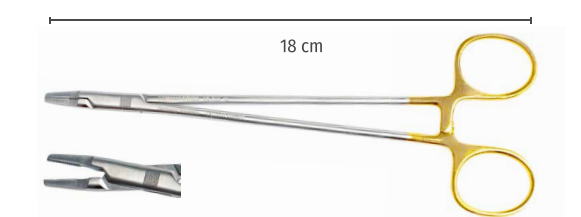

Crile-Wood Ryder Nadelhalter, Hartmetall,
verjüngte Spitzen 18 cm
Crile-Wood Ryder needleholder, tungsten carbide,
small ends, 18 cm

40-745-18



03 Tonsillektomie

Tonsillectomy



Skalpelle-Griff / Scalpel handle

Art.-Nr./No.	Nr. / No.	Länge / Length (cm)
10-360-03	3	12,0
10-360-04	4	13,5
10-360-07	7	16,0
10-360-33	3L	21,0



Skalpelle-Klingen, einzeln steril verpackt, 100 Stück Scalpel blades, single sterile packed, 100 pieces

Art.-Nr./No.	Nr. / No.	Beschreibung / Description
10-360-10	10	
10-360-11	11	spitz / pointed
10-360-15	15	gerundet / rounded



Brünings Zungenspatel, gefenestert, 19 cm
Brünings tongue depressor, fenestrated, 19 cm

40-500-19



Buchwald Zungenspatel, 19/23 mm, 18 cm
Buchwald tongue depressor, 19/23 mm, 18 cm

40-508-18

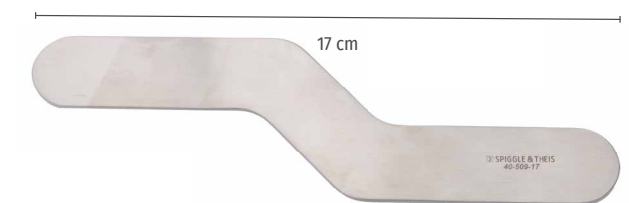

Zungenspatel, S-förmig, 17 cm
Tongue blade, s-shape, 17 cm

40-509-17



Moritz-Schmidt Zungenspatel, gefenestert, 19,5 cm
Moritz-Schmidt tongue depressor, fenestrated, 19.5 cm

40-506-19

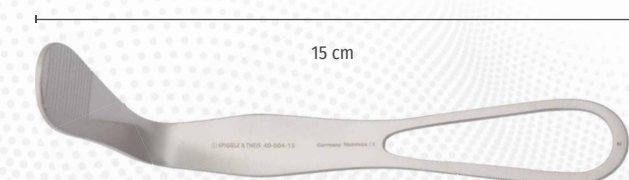

Hartmann Zungenspatel, gewinkelt, 15 cm
Hartmann tongue depressor, angled, 15 cm

40-504-15

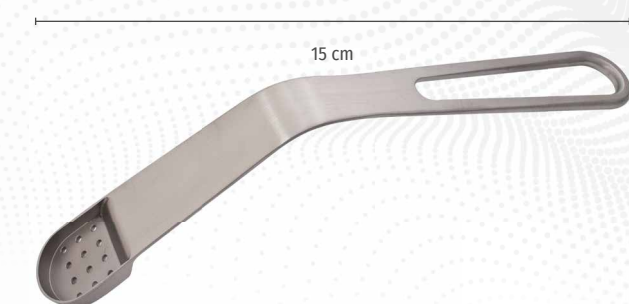

Tapia Adenoid Spatel, 15 cm / Tapia adenoid spatula, 15 cm

Art.-Nr./No.	Löcher / Holes
40-510-01	9
40-510-02	12
40-510-03	15



04 Kehlkopf

Larynx

Kehlkopfspiegel, Rhodium beschichtet, ohne Griff, ohne Gewinde Laryngeal mirror, rhodium coated, without handle, without screw



Art.-Nr./No.	Größe / Size	Länge / Length (mm)	Ø (mm)
40-524-30	000	126	6,5
40-524-20	00	127	8,5
40-524-00	0	128	10,5
40-524-01	1	130	12,5
40-524-02	2	132	14,5
40-524-03	3	133	16,0
40-524-04	4	136	18,5
40-524-05	5	137	20,0
40-524-06	6	140	22,0
40-524-07	7	141	24,0
40-524-08	8	142	26,0
40-524-09	9	143	28,0
40-524-10	10	144	30,5

Kehlkopfspiegel, Rhodium beschichtet, fester Sechskantgriff, 17 cm
Laryngeal mirror, rhodium coated, fixed hexagonal handle, 17 cm



Art.-Nr./No.	Größe / Size	Ø (mm)
40-525-30	000	6,0
40-525-20	00	8,0
40-525-00	0	10,0
40-525-01	1	12,0
40-525-02	2	14,0
40-525-03	3	16,0
40-525-04	4	18,0
40-525-05	5	20,0
40-525-06	6	22,0
40-525-07	7	24,0
40-525-08	8	26,0
40-525-09	9	28,0
40-525-10	10	30,0

Griff für Kehlkopfspiegel, Zentralverschraubung, 11 cm
Handle for laryngeal mirrors, central screw, 11 cm



40-520-00

Injektionskanüle, 0,8 mm, Luer-Lock
Injection needle, 0.8 mm, Luer-Lock



Art.-Nr./No.	Länge / Length (cm)	Beschreibung / Description
40-553-01	12	gerade / straight
40-553-02	13	bajonett / bayonet

Kehlkopf-Kanüle, gebogen, Luer-Lock, 2,7 mm, 13 cm
Laryngeal cannula, curved, Luer-Lock, 2.7 mm, 13 cm

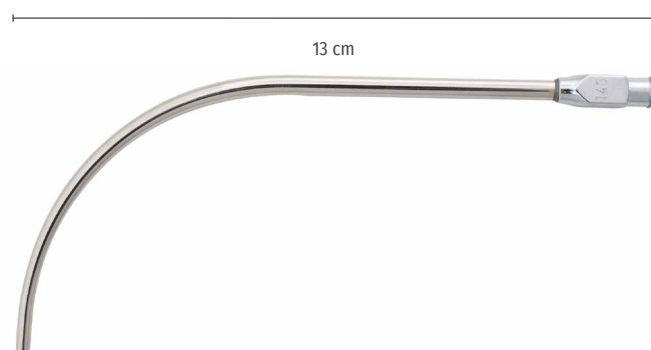

40-554-13

04 Kehlkopf

Larynx



Reichert Epiglottis Halter, gebogen, 23,5 cm
Reichert epiglottis holder, curved, 23.5 cm

40-558-24



Pelteson Kehlkopfwatteträger, gewinkelt, 2-Ring, 25,5 cm
Pelteson laryngeal cotton carrier, angled, 2 rings, 25.5 cm

40-560-22

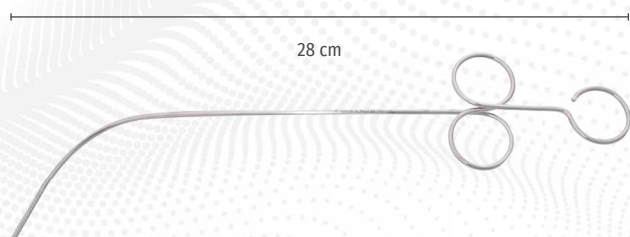

Kehlkopfwatteträger, fein, gebogen, 3-Ring, 28 cm
Laryngeal cotton carrier, fine, curved, 3 rings, 28 cm

40-561-28

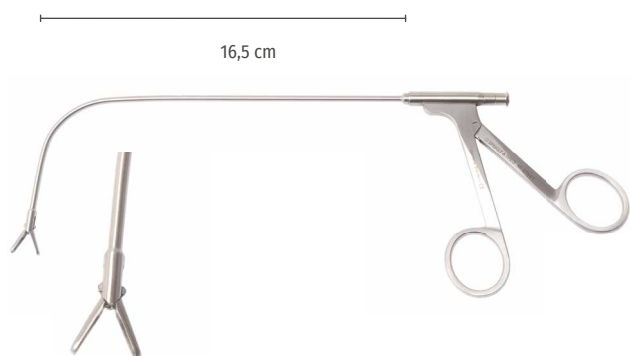

Kehlkopfzange, Rohrschaft, gebogen, ovale Löffel, Spülkanal, AL 16,5 cm
Laryngeal forceps, tubular model, curved, oval cups, irrigation channel, WL 16.5 cm

Art.-Nr./No.

Beschreibung / Description

40-570-01

vertikal / vertical

40-570-02

horizontal

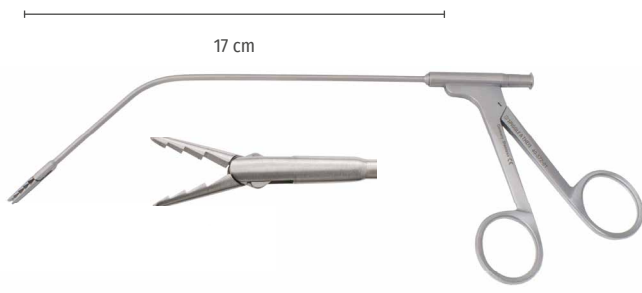

Kehlkopfzange, Rohrschaft, gebogen, Hechtmaul, Spülkanal, AL 17 cm

Laryngeal forceps, tubular model, curved, alligator jaws, irrigation channel, WL 17 cm

Art.-Nr./No.	Beschreibung / Description
40-572-01	vertikal / vertical
40-572-02	horizontal



Huber Universal Handgriff, Standard
Huber universal handle, standard

40-575-00

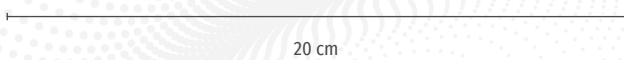

Ansatzrohr, gebogen, 20 cm / Connecting tube, curved, 20 cm

40-576-20



Brünings Löffelansatz, rund, 3 mm
Brünings tip, round cups, 3 mm

Art.-Nr./No.	Beschreibung / Description
40-578-00	gerade / straight
40-579-00	nach oben gebogen / curved upwards



Seiffert Hechtmaulansatz, gerade / Seiffert alligator tip, straight

40-580-00



Fraenkel Löffelansatz, oval, gerade, 4,5 mm
Fraenkel tip, oval cups, straight, 4.5 mm

40-581-00



05 Speichelgang

Salivary Duct



Speichelgang-Schere, gewinkelt, 11,5 cm
Salivary duct scissors, angled, 11.5 cm

Art.-Nr./No.	Beschreibung / Description
40-600-12	mit Knopf / with ball end
40-601-12	ohne Knopf / without ball end



Knopfkanüle, gerade, Luer-Lock, unsteril
Cannula ball-ended, straight, Luer-lock, non-sterile

Art.-Nr./No.	Größe / Size (mm)
40-604-08	0,8 x 80
40-604-10	1,0 x 80
40-604-12	1,2 x 80

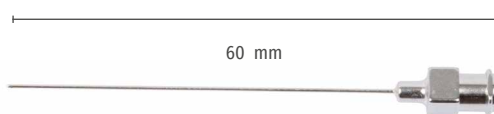

Bangerter Tränenwegkanüle, unsteril
stumpf, seitliche Öffnung, gerade, Luer-Lock
Bangerter lacrimal duct cannula, non-sterile
blunt, lateral opening, straight, Luer-lock

Art.-Nr./No.	Größe / Size (mm)
40-606-06	0,6 x 60
40-606-08	0,8 x 60



Tränenwegkanüle, stumpf, gebogen, 0,6 x 23,5 mm
Lacrimal canula, blunt, curved, 0.6 x 23.5 mm

40-607-06



Bowman Speichelgangsonde, Silber, 12,5 cm
Bowman salivary duct probe, silver, 12.5 cm

Art.-Nr./No.	Größe / Size	Ø (mm)
40-609-40	(0000/000)	0,4 / 0,6
40-609-00	(00/0)	0,7 / 0,8
40-609-01	(0/1)	0,8 / 0,9
40-609-12	(1/2)	0,9 / 1,1
40-609-23	(2/3)	1,1 / 1,3
40-609-34	(3/4)	1,3 / 1,4
40-609-45	(4/5)	1,4 / 1,5
40-609-56	(5/6)	1,5 / 1,6
40-609-67	(6/7)	1,6 / 1,8
40-609-78	(7/8)	1,8 / 1,9

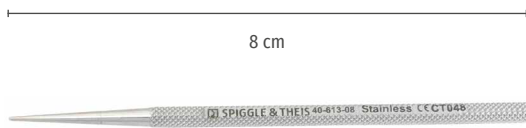

Ruedemann Dilatator für Kleinkinder, 8 cm
Ruedemann dilator for infants, 8 cm

40-613-08

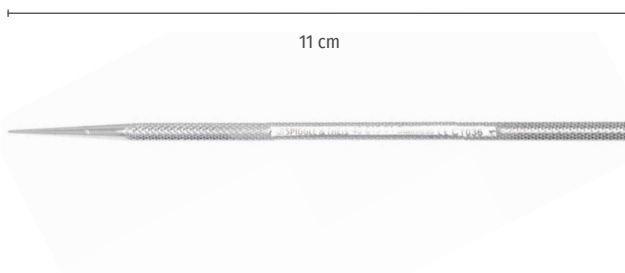

Wilder Dilatator, 11 cm / Wilder dilator, 11 cm

Art.-Nr./No.	Größe / Size
40-615-01	1
40-615-02	2
40-615-03	3



Speichelgang-Sonden-Set, doppelseitig, biegsam, Nitinol,
6 Größen (Ø 0,5/0,6 mm bis Ø 1,5/1,6 mm), 14 cm
Salivary duct probe set, double ended, bendable, Nitinol,
6 sizes (Ø 0.5/0.6 mm up to Ø 1.5/1.6 mm), 14 cm

40-617-00



06 Koagulation

Coagulation

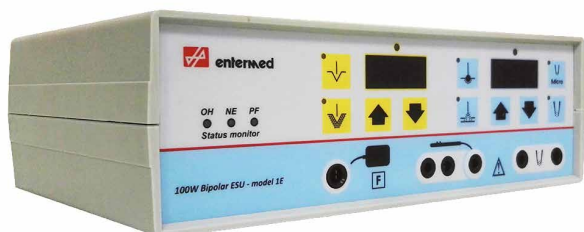

HF-Generator 1E, 100 Watt, 460 kHz, bipolar, monopolar, komplett mit Fußschalter, bipolarem Kabel 3 m, 2x Handgriff monopolar mit Kabel 3 m, 4 mm und 2,4 mm, Neutralelektrode mit Kabel 3 m
HF-generator 1E, 100 Watt, 460 kHz bipolar, monopolar, complete with footswitch, bipolar cable 3 m, 2x handle monopolar with cable 3 m, 4.0 mm and 2.4 mm neutral electrode with cable 3 m

80-002-80



Silikon Neutral-Elektrode, 8 x 15 cm, 4 m Kabel, passend für silicone neutral electrode, 8 x 15 cm, 4 m cable, fitting to Micromed/Martin/Berchthold/Aesculap/ SPIGGLE & THEIS

80-010-40



Silikon Neutral-Elektrode, 17 x 30 cm, 4 m Kabel, passend für silicone neutral electrode, 17 x 30 cm, 4 m cable, fitting to Micromed/Martin/Berchthold/Aesculap/SPIGGLE & THEIS

80-011-40



Halteband für Neutralelektrode, Gummi, 75 cm
Holding band for neutral electrode, rubber, 75 cm

80-012-75



Elektroden-Handgriffe, autoklavierbar, mit zwei Schaltern, schneiden und koagulieren, für abnehmbare Anschlusskabel
Electrode Handle, autoclavable, with 2 switches, cutting and coagulating, for removable connecting cable

Art.-Nr./No.	Ansatz / plug (mm)
80-406-01	4,0
80-406-02	2,4



Elektroden-Handgriffe, autoklavierbar, mit fest verbundenem Anschlusskabel, 4 m, passend für Erbe
Electrode Handle, autoclavable, with fixed connecting cable, 4 m, compatible to Erbe

Art.-Nr./No.	Ansatz / plug (mm)
80-410-04	4,0
80-410-24	2,4



Elektroden-Handgriffe, autoklavierbar, mit fest verbundenem Anschlusskabel, 4 m, passend für International
Electrode Handle, autoclavable, with fixed connecting cable, 4 m, compatible to International

Art.-Nr./No.	Ansatz / plug (mm)
80-411-04	4,0
80-411-24	2,4



Elektroden-Handgriffe, autoklavierbar, mit fest verbundenem Anschlusskabel, 4 m, passend für Martin
Electrode Handle, autoclavable, with fixed connecting cable, 4 m, compatible to Martin

Art.-Nr./No.	Ansatz / plug (mm)
80-412-04	4,0
80-412-24	2,4



Monopolares Anschlusskabel für Einmal Neutral-Elektrode, 4,5 m, passend für
Monopolar connecting cable for single-use patient plates, 4.5 m, compatible to
Micromed/Martin/Integra/Berchtold/Aesculap/Erbe ICC/ACC/T-Serie

80-413-00



06 Monopolares Zubehör, monopolare Anschlusskabel, autoklavierbar

Monopolar Accessory, monopolar connecting cable, autoclavable



Für SPIGGLE & THEIS Elektroden-Handgriffe, 4 m, passend für
for SPIGGLE & THEIS electrode handles, 4 m, compatible to
Sutter/Martin/Berchtold/Aesculap/Integra/SPIGGLE & THEIS

80-407-40



Für SPIGGLE & THEIS Elektroden-Handgriffe, 4 m, passend für
for SPIGGLE & THEIS electrode handles, 4 m, compatible to
Erbe ICC/ACC, Wolf/Storz

80-408-40



Für Erbe Elektroden-Handgriffe, 3 m, passend für
for Erbe electrode handles, 3 m, compatible to
Erbe ICC/ACC, Wolf/Storz

80-409-30



Für Instrumente, 4 mm, 5 m, passend für
for instruments, 4 mm, 5 m, compatible to
Sutter/Martin/Berchtold/Aesculap / Integra/SPIGGLE & THEIS

80-414-50



Für Instrumente, 4 mm, 5 m, passend für
for instruments, 4 mm, 5 m, compatible to
Erbe ICC/ACC, Wolf/Storz

80-415-50



Für Instrumente, 5 m, passend für
for instruments, 5 m, compatible to
Valleylab, Conmed/Bovie

80-445-15

06 Bipolares Zubehör, bipolare Anschlusskabel

Bipolar Accessory, bipolar connecting cable



passend für / compatible to
Erbe/EMC/Dolly Stecker

Art.-Nr./No.	Länge / Length (m)
80-316-50	5



passend für / compatible to
Sutter/Martin/Berchtold/Aesculap/Integra/SPIGGLE & THEIS

Art.-Nr./No.	Länge / Length (m)
80-317-30	3
80-317-50	5



passend für / compatible to
Erbe/Storz/Wolf

Art.-Nr./No.	Länge / Length (m)
80-318-30	3
80-318-50	5



passend für / compatible to
Valleylab/Lamidey/EMC/Bowa/Olympus

Art.-Nr./No.	Länge / Length (m)
80-319-30	3
80-319-50	5



für bipolare Scheren, passend für
for bipolar scissors, compatible to
Sutter/Martin/Berchtold/Aesculap/Integra/SPIGGLE & THEIS

Art.-Nr./No.	Länge / Length (m)
80-320-30	3
80-320-50	5



für bipolare Scheren/Zangen, passend für
for bipolar scissors/forceps, compatible to
Erbe/Storz/Wolf

Art.-Nr./No.	Länge / Length (m)
80-322-30	3
80-322-50	5



06 Koagulation

Coagulation



Monopolare Messerelektrode, seitliche Spitze mit Schaft 4 mm, schwarz, 5 Stück/Box

Monopolar knife electrode, cutting edge sideways with 4mm shaft, black, 5 pieces /box

80-053-01



Monopolare Nadelelektrode, Ø 0,5 mm m. Schaft 4 mm, schwarz, 5 Stück/Box

Monopolar needle electrode, Ø 0.5 mm with 4 mm shaft, black, 5 pieces /box

80-053-02



Monopolare Drahtschlingen-Elektrode, Ø 5 mm mit Schaft 4 mm, schwarz, 5 Stück/Box

Monopolar wire loop electrode, Ø 5 mm with 4 mm shaft, black, 5 pieces /box

80-053-03



Monopolare Kugelelektrode, gerade Ø 4 mm mit Schaft 4 mm, schwarz, 5 Stück/Box

Monopolar ball electrode, straight Ø 4 mm with 4 mm shaft , black, 5 pieces /box

80-053-04



Monopolare Kugelelektrode, gerade Ø 2 mm mit Schaft 4 mm, schwarz, 5 Stück/Box

Monopolar ball electrode, straight Ø 2 mm with 4 mm shaft , black, 5 pieces /box

80-053-05

13 / 14 / 17,5 / 18 cm

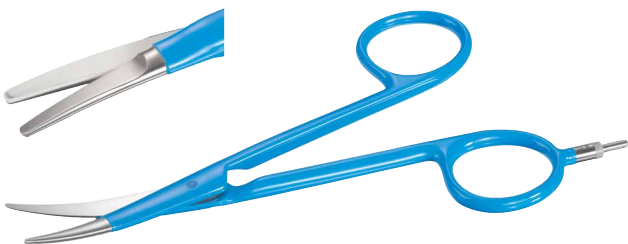

Bipolare Präparierschere

Bipolar dissecting scissors

Art.-Nr. Art.-No.	Beschreibung Description	Länge Length (cm)
80-180-13	feines Blatt delicate blade	13,0
80-181-14	feines Blatt delicate blade	14,0
80-182-17	feines Blatt delicate blade	17,5
80-183-18	standard Blatt standard blade	18,0

Bis heute stellt das Verkleben beim Koagulieren mit bipolaren Pinzetten ein verbreitetes Problem für den Operateur dar. **NON-STICK bipolare Pinzetten** lösen dieses Problem.

Punktuelle Überhitzungen werden vermieden. Das Gewebe löst sich leicht von der Pinzette.

Diese Eigenschaften bleiben bei ordnungsgemäßer Anwendung über die gesamte Lebensdauer des Instruments erhalten.

An adhesion when coagulating with bipolar forceps is a common problem for the surgeon. Our **NON-STICK bipolar forceps** solve this problem.

No punctual overheating. Tissue detaches easily from forceps.

With correct usage these characteristics remain over the entire life span of the instrument.



Vorteile:

- Kein Verkleben da Arbeitsteile aus massivem Silber mit Goldüberzug sind
- Präzises Arbeiten ohne Unterbrechungen
- Perfekte Parallelführung durch Stopp-Führungsstift
- Flächiges Koagulieren durch "Perfect-Grip"-Arbeitsteil
- Autoklavierbar
- Passend für alle gängigen HF-Systeme durch Standard-Anschluss

Advantages:

- No adhesion due to gold plated solid silver tips
- Precise working without interruptions
- Perfect parallel motion through guide pin
- Areal coagulation with "Perfect Grip" working part
- Autoclavable
- Standard adapter grants compatibility to all current HF-systems



06 Bipolare Pinzetten, X-FINE, NON-STICK, bajonett, Führungsstift

Bipolar Forceps, X-FINE, NON-STICK, bayonet, guide pin



Spitze gerade / tip straight

Art.-Nr. Art.-No.	Länge Length (cm)	Spitze Tip (mm)
80-150-17	17	0,4 x 4,0
80-150-20	20	0,4 x 4,0
80-150-23	23	0,4 x 4,0
80-150-25	25	0,4 x 4,0
80-152-17	17	0,7 x 4,0
80-152-20	20	0,7 x 4,0
80-152-23	23	0,7 x 4,0



Spitze aufwärts gewinkelt / tip upwards angled

Art.-Nr. Art.-No.	Länge Length (cm)	Spitze Tip (mm)
80-156-20	20	0,4 x 4,0
80-156-23	23	0,4 x 4,0



Spitze abwärts gewinkelt / tip downwards angled

Art.-Nr. Art.-No.	Länge Length (cm)	Spitze Tip (mm)
80-158-20	20	0,4 x 4,0
80-158-23	23	0,4 x 4,0

06 Bipolare Pinzetten, NON-STICK, Führungsstift

Bipolar Forceps, NON-STICK, guide pin



16 / 19,5 / 22 cm

gerade / straight

Art.-Nr. Art.-No.	Länge Length (cm)	Spitze Tip (mm)
80-100-16	16,0	0,5 x 8,0
80-100-19	19,5	0,5 x 8,0
80-101-16	16,0	1,0 x 8,0
80-101-19	19,5	1,0 x 8,0
80-101-22	22,0	1,0 x 8,0
80-103-16	16,0	2,0 x 8,0
80-103-19	19,5	2,0 x 8,0



16 / 19,5 / 25 cm

gerade, Spitze gewinkelt / straight, tip angled

Art.-Nr. Art.-No.	Länge Length (cm)	Spitze Tip (mm)
80-105-16	16,0	0,5 x 8,0
80-105-19	19,5	0,5 x 8,0
80-106-16	16,0	1,0 x 8,0
80-106-19	19,5	1,0 x 8,0
80-106-25	25,0	1,0 x 8,0
80-107-16	16,0	2,0 x 8,0
80-107-19	19,5	2,0 x 8,0



16 / 19,5 cm

bajonett / bayonet

Art.-Nr. Art.-No.	Länge Length (cm)	Spitze Tip (mm)
80-110-16	16,0	0,5 x 8,0
80-110-19	19,5	0,5 x 8,0
80-111-16	16,0	1,0 x 8,0
80-111-19	19,5	1,0 x 8,0
80-112-16	16,0	2,0 x 8,0
80-112-19	19,5	2,0 x 8,0



16 / 19,5 / 23 cm

bajonett / bayonet

Art.-Nr. Art.-No.	Länge Length (cm)	Spitze Tip (mm)
80-109-16	16,0	0,2 x 5,0
80-113-19	19,5	0,2 x 5,0
80-113-23	23,0	0,2 x 5,0
80-114-19	19,5	0,5 x 6,0
80-115-19	19,5	1,0 x 6,0
80-116-19	19,5	1,5 x 6,0



06 Bipolare Pinzetten, NON-STICK, Führungsstift

Bipolar Forceps, NON-STICK, guide pin



Bajonett, Spitze nach oben gewinkelt, 19,5 cm
 bayonet, tip angled upwards, 19.5 cm

Art.-Nr./No.	Spitze / Tip (mm)
80-117-19	0,2 x 8,0
80-118-19	1,0 x 8,0
80-119-19	2,0 x 8,0



Bajonett, Spitze nach oben gewinkelt, 14 mm, 4 mm unisoliert, 1,5 mm, 19,5 cm
 bayonet, tip upwards angled, 14 mm, 4 mm unisolated, 1.5 mm, 19.5 cm

80-120-19



Meuser, 60° gebogen, 2 mm, 18 cm
 Meuser, 60° curved, 2 mm, 18 cm

80-121-18



Kniegebogen, extra fein, 0,2 x 8,0 mm, 16,5 cm
 angled, very fine, 0.2 x 8.0 mm, 16.5 cm

80-123-16



Bajonett, Spitze nach oben gewinkelt, 25 cm
 bayonet, tip upwards angled, 25 cm

Art.-Nr. Art.-No.	Spitze Tip (mm)	
80-127-03	0,3 x 8,0	
80-127-07	0,7 x 8,0	
80-127-12	1,2 x 8,0	
80-127-20	2,0 x 8,0	
80-129-12	1,2 x 14,0	8 mm unisoliert 8 mm unisolated

06 Bipolare Pinzetten, NON-STICK, bajonett, Führungstift

Bipolar Forceps, NON-STICK, bayonet, guide pin



Spitze nach unten gewinkelt, 25 cm
tip downwards angled, 25 cm

Art.-Nr./No.	Spitze / Tip (mm)
80-128-03	0,3 x 8,0
80-128-07	0,7 x 8,0
80-128-12	1,2 x 8,0
80-128-20	2,0 x 8,0



Spitze gerade, 25 cm / tip straight 25 cm

Art.-Nr./No.	Spitze / Tip (mm)
80-125-03	0,3 x 8,0
80-125-07	0,7 x 8,0
80-125-12	1,2 x 8,0
80-125-20	2,0 x 8,0

07 Bipolare Saugpinzetten

Bipolar Suction Forceps



Nach Meuser mit Absaugung, 60° gebogen, 3,2 mm, 21 cm
Meuser with suction, 60° upcurved, 3.2 mm, 21 cm

80-122-18

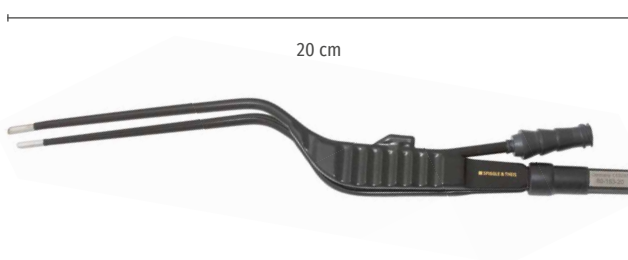

Saugunterbrecher, bajonett, 20 cm
suction control, bayonet, 20 cm

Art.-Nr./No.	Spitze / Tip (mm)
80-183-14	1,4 x 8,0
80-183-20	2,2 x 8,0



06 Koagulation

Coagulation

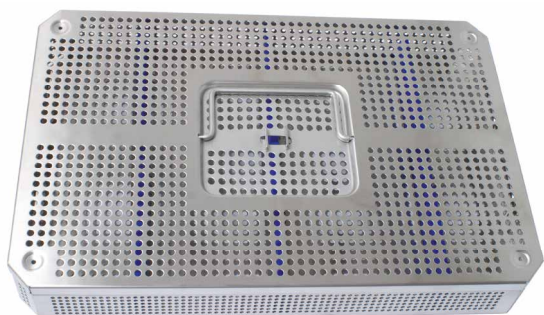

Siebkorb mit Deckel, 3/4, Edelstahl, gelocht, 405 x 255 x 75 mm
Storage- and cleaning tray with lid, 3/4, stainless steel,
perforated, 405 x 255 x 75 mm

80-260-34

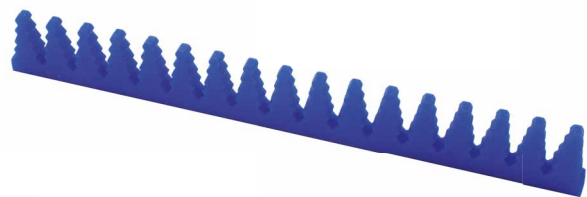

Silikonhalterung, Typ 1, Bäumchen, T-Profil, blau, 24 cm
Silicone holder, type 1, tree shaped, t-profile, blue, 24 cm

80-270-24

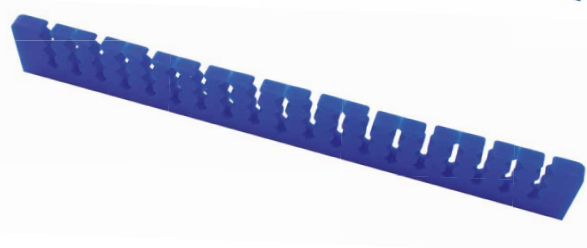

Silikonhalterung, Typ 2, Universal, T-Profil, blau, 24 cm
Silicone holder, type 2, universal, t-profile, blue, 24 cm

80-272-24

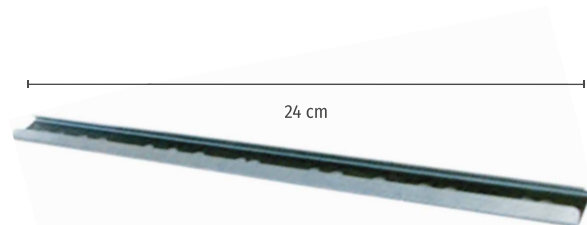

Leiste für Silikonhalterungen, Edelstahl, T-Profil, 24 cm
Bar for silicone holders, stainless steel, t-profile, 24 cm

80-275-24



Schraube, Edelstahl, M2, 9 x 16 mm
Screw, stainless steel, M2, 9 x 16 mm

80-280-00

SET - 80-250-00

Bestehend aus / consisting of:

- 1 x 80-260-34
- 1 x 80-270-24
- 1 x 80-272-24
- 2 x 80-275-24
- 24 x 80-280-00

07 Tracheotomie, Weichteile, Allgemeines

Tracheotomy, Neck Dissection, Miscellaneous



Sternberg Lippenhaken / Sternberg lip retractor

Art.-Nr./No.	Länge / Length (cm)
80-302-12	12,0
80-302-14	13,5
80-302-16	15,5

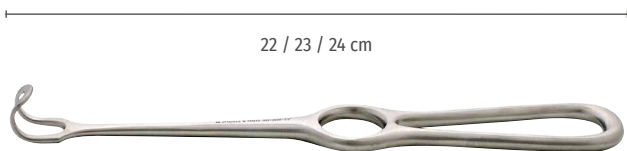

Middeldorpf Wundhaken, Ringgriff

Middeldorpf antrum retractor, ring handle

Art.-Nr. Art.-No.	Maße Dimensions (mm)	Länge Length (cm)
80-306-17	15,0 x 16,5	22
80-306-22	20,0 x 22,0	23
80-306-30	25,0 x 30,0	24



Kocher-Langenbeck Wundhaken, Ringgriff, 21 cm

Kocher-Langenbeck retractor, ring handle, 21 cm

Art.-Nr. Art.-No.	Maße Dimensions (mm)
80-308-06	25,0 x 6,0
80-308-07	35,0 x 8,0
80-308-10	35,0 x 11,0
80-308-15	35,0 x 15,0
80-308-20	60,0 x 20,0



07 Tracheotomie, Weichteile, Allgemeines

Tracheotomy, Neck Dissection, Miscellaneous

21 / 22 / 23 cm



Langenbeck Wundhaken, Ringgriff
Langenbeck retractor, ring handle

Art.-Nr. Art.-No.	Maße Dimensions (mm)	Länge Length (cm)
80-309-11	31,0 x 11,0	23
80-309-14	31,0 x 14,0	23
80-309-16	31,0 x 16,0	23
80-309-41	41,0 x 11,0	22
80-309-51	51,0 x 11,0	21

23 cm



Volkman Wundhaken, Ringgriff, 23 cm
Volkman retractor, ring handle, 23 cm

Art.-Nr./No.	Beschreibung / Description
80-330-01	1-zinkig, scharf / 1 prong, sharp
80-330-02	2-zinkig, scharf / 2 prongs, sharp
80-330-03	3-zinkig, scharf / 3 prongs, sharp
80-330-04	4-zinkig, scharf / 4 prongs, sharp
80-330-06	6-zinkig, scharf / 6 prongs, sharp
80-332-01	1-zinkig, stumpf / 1 prong, blunt
80-332-02	2-zinkig, stumpf / 2 prongs, blunt
80-332-03	3-zinkig, stumpf / 3 prongs, blunt
80-332-04	4-zinkig, stumpf / 4 prongs, blunt
80-332-06	6-zinkig, stumpf / 6 prongs, blunt

20,5 cm



Schönborn Schilddrüsenhaken, 6,5 x 13 mm, 20,5 cm
Schönborn thyroid retractor, 6,5 x 13 mm, 20,5 cm

80-312-21

16,5 cm



Senn-Miller Wundhaken, doppelendig, 3 Zähne, 16,5 cm
Senn-Miller retractor, double ended, 3 teeth, 16,5 cm

Art.-Nr./No.	Beschreibung / Description
80-314-16	stumpf / blunt
80-315-16	scharf / sharp

07 Tracheotomie, Weichteile, Allgemeines

Tracheotomy, Neck Dissection, Miscellaneous



Roux Wundhaken, doppelendig / Roux retractor, double ended

Art.-Nr. Art.-No.	Maße Dimensions (mm)	Länge Length (cm)
80-318-01	20,8 x 25,0 / 28,5 x 30,50	14,5
80-318-02	25,5 x 28,0 / 37,0 x 33,15	15,5
80-318-03	30,0 x 31,5 / 41,9 x 38,50	16,5



Baby-Roux Haken, doppelendig, 16 x 16 und 21 x 19 mm, 13,5 cm
Baby-Roux retractor, double ended, 16 x 16 and 21 x 19 mm, 13.5 cm

80-317-00



Trachealhäkchen, glatter Griff, 17 cm
Trachea hook, flat handle, 17 cm



Art.-Nr./No.	Beschreibung / Description
80-340-01	1-zinkig, scharf / 1 prong, sharp
80-340-02	2-zinkig, scharf / 2 prongs, sharp
80-340-03	3-zinkig, scharf / 3 prongs, sharp
80-340-04	4-zinkig, scharf / 4 prongs, sharp
80-342-01	1-zinkig, stumpf / 1 prong, blunt
80-342-02	2-zinkig, stumpf / 2 prongs, blunt
80-342-03	3-zinkig, stumpf / 3 prongs, blunt
80-342-04	4-zinkig, stumpf / 4 prongs, blunt



07 Tracheotomie, Weichteile, Allgemeines

Tracheotomy, Neck Dissection, Miscellaneous



Halsted-Mosquito-Klemme, 12,5 cm
Halsted-Mosquito artery forceps, 12.5 cm

Art.-Nr./No.	Beschreibung / Description
80-350-01	gerade, anat. / straight, anat.
80-350-02	gebogen, anat. / curved, anat.
80-350-03	gerade, chir. / straight, 1:2 teeth
80-350-04	gebogen, chir. / curved, 1:2 teeth



Halsted-Mosquito-Klemme, mikro, 12,5 cm
Halsted-Mosquito artery forceps, micro, 12.5 cm

Art.-Nr./No.	Beschreibung / Description
80-352-01	gerade, anat. / straight, anat.
80-352-02	gebogen, anat. / curved, anat.
80-352-03	gerade, chir. / straight, 1:2 teeth
80-352-04	gebogen, chir. / curved, 1:2 teeth
80-353-01	gebogen, sehr fein, 12 cm / curved, very fine 12 cm

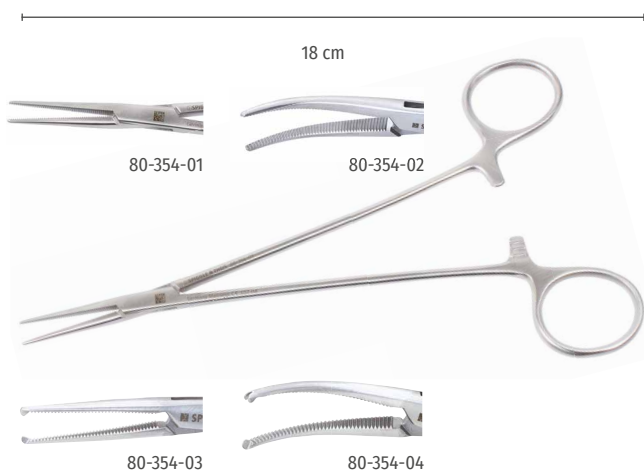

Halsted-Mosquito-Klemme, 18 cm
Halsted-Mosquito artery forceps, 18 cm

Art.-Nr./No.	Beschreibung / Description
80-354-01	gerade, anat. / straight, anat.
80-354-02	gebogen, anat. / curved, anat.
80-354-03	gerade, chir. / straight, 1:2 teeth
80-354-04	gebogen, chir. / curved, 1:2 teeth

07 Tracheotomie, Weichteile, Allgemeines

Tracheotomy, Neck Dissection, Miscellaneous

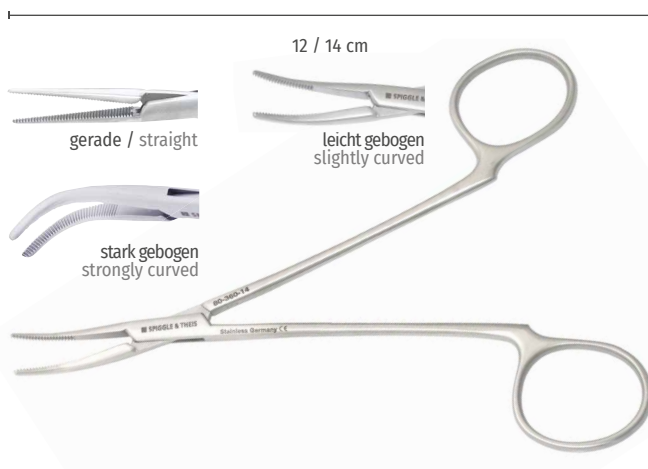

Präparierklemme ohne Sperre, anatomisch Artery forceps without ratchet, anatomical

Art.-Nr. Art.-No.	Länge Length (cm)	Beschreibung Description
80-356-12	12,0	gerade / straight
80-359-14	14,0	gerade / straight
80-357-12	12,0	leicht gebogen / slightly curved
80-360-14	14,0	leicht gebogen / slightly curved
80-361-14	14,0	stark gebogen / strongly curved

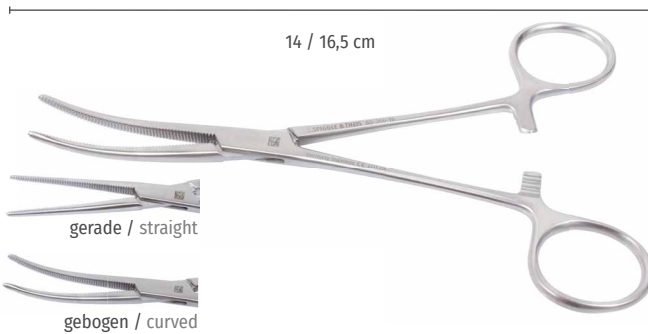

Pean Arterienklemme, anatomisch, fein Pean artery forceps, anatomical, fine

Art.-Nr. Art.-No.	Länge Length (cm)	Beschreibung Description
80-365-14	14,0	gerade / straight
80-365-16	16,5	gerade / straight
80-366-14	14,0	gebogen / curved
80-366-16	16,5	gebogen / curved

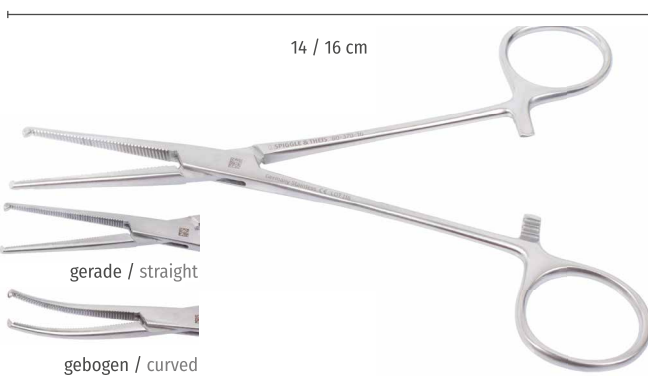

Kocher Arterienklemme, chirurgisch, fein Kocher artery forceps, 1:2 teeth, fine

Art.-Nr. Art.-No.	Länge Length (cm)	Beschreibung Description
80-370-14	14,0	gerade / straight
80-370-16	16,0	gerade / straight
80-372-14	14,0	gebogen / curved
80-372-16	16,0	gebogen / curved

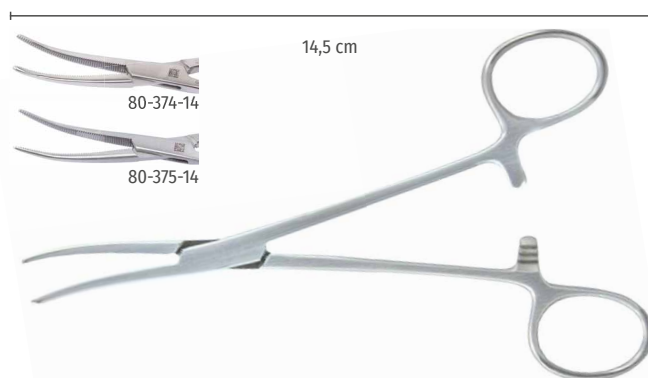

Crile Arterienklemme, anatomisch, gebogen, 14,5 cm Crile artery forceps, anatomical, curved, 14,5 cm

Art.-Nr./No.	Beschreibung / Description
80-374-14	normal / standard
80-375-14	mikro / micro



07 Tracheotomie, Weichteile, Allgemeines

Tracheotomy, Neck Dissection, Miscellaneous



Crile Arterienklemme, anatomisch, gebogen, 16 cm
Crile artery forceps, anatomical, curved, 16 cm

80-376-16



Baby-Adson Präparierklemme, 90° gebogen, 18 cm
Baby-Adson artery forceps, 90° curved, 18 cm

80-380-18



Rochester-Pean Arterienklemme, anatomisch, gerade
Rochester-Pean artery forceps, anatomical, straight

Art.-Nr./No.	Länge / Length (cm)
80-382-18	18,5
80-382-20	20,0



Rochester-Pean Arterienklemme, anatomisch, gebogen
Rochester-Pean artery forceps, anatomical, curved

Art.-Nr./No.	Länge / Length (cm)
80-383-18	18,5
80-383-20	20,5
80-383-22	22,0

07 Tracheotomie, Weichteile, Allgemeines

Tracheotomy, Neck Dissection, Miscellaneous

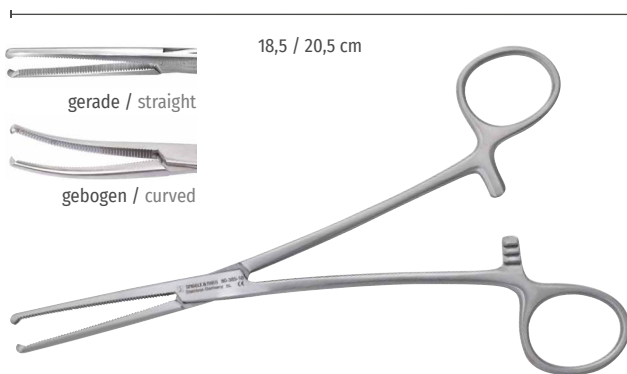

Ochsner-Kocher Arterienklemme, chirurgisch, 1:2 Zähne
Ochsner-Kocher artery forceps, 1:2 teeth

Art.-Nr. Art.-No.	Länge Length (cm)	Beschreibung Description
80-385-18	18,5	recto / straight
80-385-20	20,5	recto / straight
80-387-18	18,5	curvo / curved
80-387-20	20,5	curvo / curved



Backhaus Tuchklemme, scharf, gebogen
Backhaus towel clamp, sharp, curved

Art.-Nr./No.	Länge / Length (cm)
80-392-09	9
80-392-11	11
80-392-13	13



Edna-Lorna Tuchklemme, stumpf, gerade, für Papiertücher
Edna-Lorna towel clamp, blunt, straight, for paper towels

Art.-Nr./No.	Länge / Length (cm)
80-394-09	10,0
80-394-13	13,5



07 Tracheotomie, Weichteile, Allgemeines

Tracheotomy, Neck Dissection, Miscellaneous

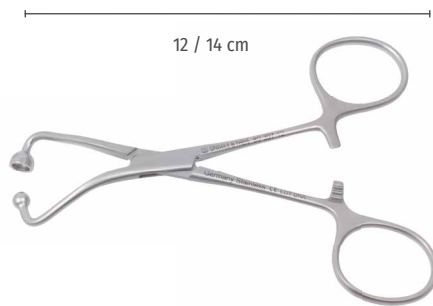

Tuchklemme zum schonenden Fassen von Papiertüchern, Kugel, gebogen

Towel clamp for careful holding of paper towels, ball-end, curved

Art.-Nr./No.	Länge / Length (cm)
80-397-12	12
80-397-14	14



Allis Gewebe-Fasszange, gerade, 4:5 Zähne, 15,5 cm

Allis tissue holding forceps, straight, 4:5 teeth, 15.5 cm

80-400-15

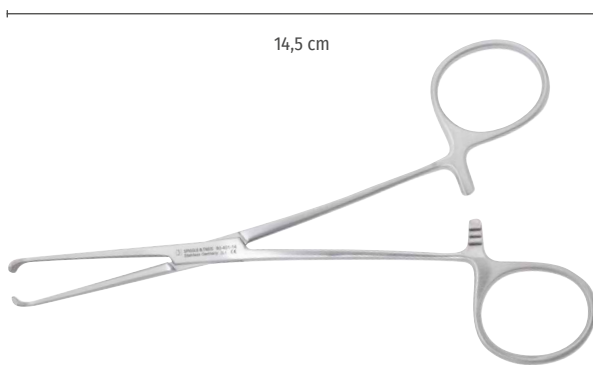

Baby-Allis Gewebe-Fasszange, gerade, 4:5 Zähne, 14,5 cm

Baby-Allis tissue holding forceps, straight, 4:5 teeth, 14.5 cm

80-401-14



Braun Hakenzange, 4:4 Zähne, scharf, gerade, 15,5 cm

Braun hook forceps, 4:4 teeth, sharp, straight, 15.5 cm

80-403-15

07 Tracheotomie, Weichteile, Allgemeines

Tracheotomy, Neck Dissection, Miscellaneous

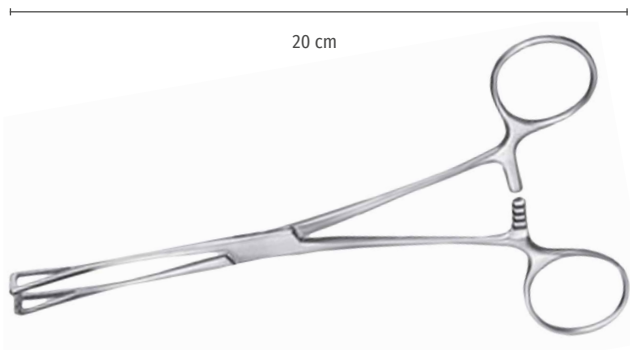

Duval Gewebegewebe, gerade, 15 mm breit, 20 cm
Duval tissue forceps, straight, 15 mm wide, 20 cm

80-405-20



Collin Zungenzange, gerade, 16 cm
Collin tongue forceps, straight, 16 cm

80-407-16

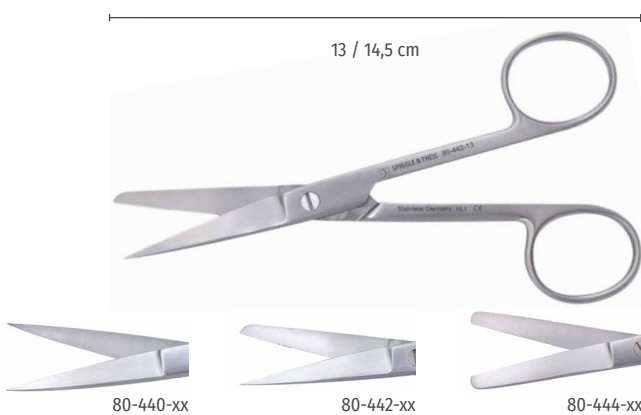

Cooper Schere, gerade / Cooper scissors, straight

Art.-Nr. Art.-No.	Länge Length (cm)	Beschreibung Description
80-440-13	13,0	spitz-spitz / sharp-sharp
80-440-15	14,5	spitz-spitz / sharp-sharp
80-442-13	13,0	spitz-stumpf / sharp-blunt
80-442-15	14,5	spitz-stumpf / sharp-blunt
80-444-13	13,0	stumpf-stumpf / blunt-blunt
80-444-15	14,5	stumpf-stumpf / blunt-blunt



07 Tracheotomie, Weichteile, Allgemeines

Tracheotomy, Neck Dissection, Miscellaneous



Cooper Schere, gebogen / Cooper scissors, curved

Art.-Nr. Art.-No.	Länge Length (cm)	Beschreibung Description
80-446-13	13,0	spitz-spitz / sharp-sharp
80-446-15	14,5	spitz-spitz / sharp-sharp
80-448-13	13,0	spitz-stumpf / sharp-blunt
80-450-13	13,0	stumpf-stumpf / blunt-blunt
80-450-15	14,5	stumpf-stumpf / blunt-blunt



Mayo-Still Schere, stumpf-stumpf Mayo-Still scissors, blunt-blunt

Art.-Nr. Art.-No.	Länge Length (cm)	Beschreibung Description
80-455-15	15,0	gerade / straight
80-455-17	17,0	gerade / straight
80-457-15	15,0	gebogen / curved



Mayo-Still Schere, Hartmetall, stumpf-stumpf, 15 cm Mayo-Still scissors, tungsten carbide, blunt-blunt, 15 cm

Art.-Nr./No.	Beschreibung / Description
80-459-15	gerade / straight
80-460-15	gebogen / curved



Lister Verbandsschere, gewinkelt Lister bandage scissors, angled

Art.-Nr./No.	Länge / Length (cm)
80-465-15	14,5
80-465-18	18,5
80-465-20	20,0

07 Tracheotomie, Weichteile, Allgemeines

Tracheotomy, Neck Dissection, Miscellaneous

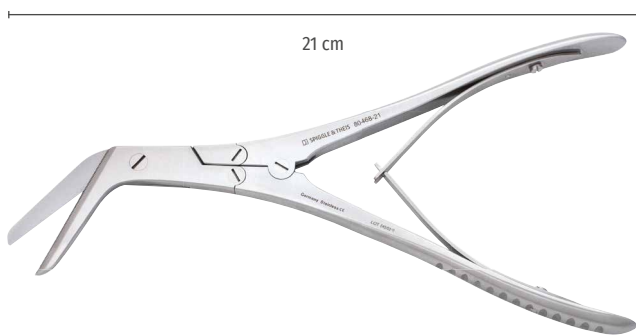

Kilian Laryngofissur-Schere, gewinkelt, gezahnt, 21 cm
Kilian laryngectomy scissors, angled, serrated, 21 cm

80-468-21



Kocher Führungssonde, mit Öffnung, 12,5 mm, 16,5 cm
Kocher director, with opening, 12,5 mm, 16.5 cm

80-470-16



Hohlsonde, gerade, 14,5 cm / Hollow probe, straight, 14.5 cm

80-471-15

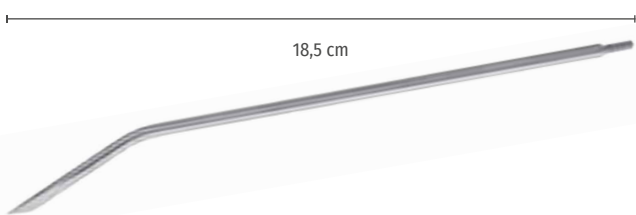

Redon Führungsnadel, Lanzettspitze, leicht gebogen, 18,5 cm
Redon guide needle, lancet tip, slightly curved, 18.5 cm

Art.-Nr./No.

AD / OD (mm)

80-472-25

2,5

80-472-35

3,5

80-472-40

4,0



07 Tracheotomie, Weichteile, Allgemeines

Tracheotomy, Neck Dissection, Miscellaneous

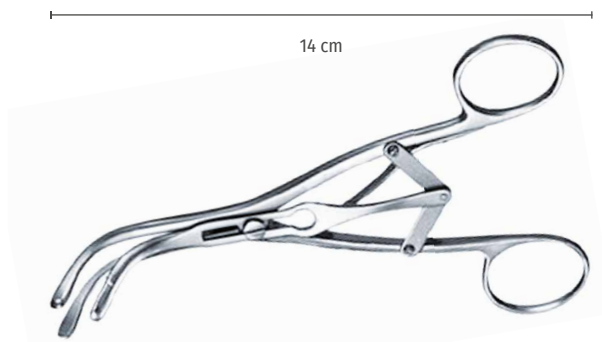

Laborde Trachealdilatator, 3-armig, 14 cm
Laborde tracheal dilator, 3 prongs, 14 cm

80-478-14

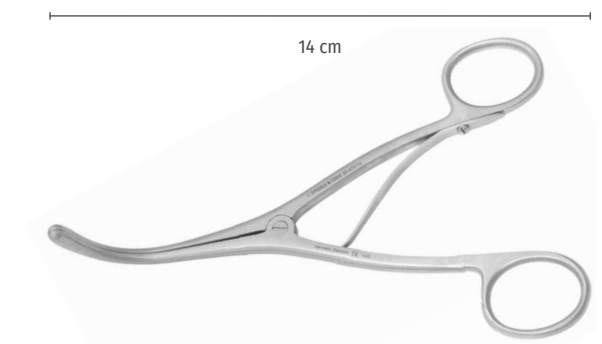

Laborde Trachealdilatator, 2-armig, 14 cm
Laborde tracheal dilator, 2 prongs, 14 cm

80-479-14



Weerda Trachealspekulum, 19 cm
Weerda tracheal speculum, 19 cm

80-482-19

07 Tracheotomie, Weichteile, Allgemeines

Tracheotomy, Neck Dissection, Miscellaneous



Metallschale / Metal bowl

Art.-Nr. Art.-No.		Durchmesser Diameter (mm)	Höhe Height (mm)	Fassungs- vermögen Capacity (ml)
80-501-01	B1	Ø 40	H=19	20
80-501-02	B2	Ø 60	H=29	60
80-501-03	B3	Ø 85	H=40	160
80-501-04	B4	Ø 110	H=55	400



Medizinbecher, Edelstahl, graduiert

Medicine cup, stainless steel, graduated

Art.-Nr. Art.-No.		Durchmesser Diameter (mm)	Höhe Height (mm)	Fassungs- vermögen Capacity (ml)
80-503-03		Ø 50	H=25	30
80-504-05		Ø 53	H=45	50



Lösungsschale, Edelstahl / Solution bowl, stainless steel

Art.-Nr. Art.-No.		Durchmesser Diameter (mm)	Höhe Height (mm)	Fassungs- vermögen Capacity (ml)
80-505-10		Ø 72	H=33	100
80-505-20		Ø 87	H=50	200
80-506-30		Ø 95	H=60	300
80-507-40		Ø 120	H=70	500
80-509-75		Ø 150	H=75	750



Tablettenschale, Edelstahl, Ø 65 mm, H=19 mm

Tablet dish, stainless steel, Ø 65 mm, H=19 mm

80-512-00



Petrirschale, Klarglas, mit Deckel / Petri dish, clear glass, with lid

Art.-Nr./No.	AD / OD (mm)	Höhe / Height (mm)
80-515-06	60	15
80-515-08	80	15
80-515-10	100	20



07 Tracheotomie, Weichteile, Allgemeines

Tracheotomy, Neck Dissection, Miscellaneous



80-519-00



80-519-01



80-519-02



80-519-03

Medikamenten-Schälchen, Dappenglas, farbig, Ø 3,2 cm Medication dish, dappen-glass, colored, Ø 3.2 cm

Art.-Nr./No.	Farbe / Color
80-519-00	kristall / crystal
80-519-01	grün / green
80-519-02	rosa / pink
80-519-03	topas / topaz



Porzellan-Schälchen, rund, mit Ausguss China bowl, round, with spout

Art.-Nr./No.	Durchmesser / Diameter (cm)
80-520-06	Ø 8
80-520-08	Ø 10



Nierenschale, Edelstahl / Kidney bowl, stainless steel

Art.-Nr./No.	Größe / Size (cm)
80-525-17	17,5
80-525-25	25,0



Kornzangen-Behälter, Edelstahl / Forceps holder, stainless steel

Art.-Nr. Art.-No.	Durchmesser Diameter (cm)	Höhe Height (cm)
80-528-13	Ø 5,0	13,5
80-528-18	Ø 5,0	18,0
80-528-20	Ø 9,5	20,0



Kornzangen-Behälter, Glas, Edelstahldeckel mit Ausschnitt, Ø 8 cm, Höhe 20 cm

Forceps holder, glass, stainless steel lid with opening,
Ø 8 cm, height 20 cm

80-530-20

07 Tracheotomie, Weichteile, Allgemeines

Tracheotomy, Neck Dissection, Miscellaneous



Norm-Sterilisations-Container, Boden geschlossen

Norm sterilization container, bottom closed

Art.-Nr. Art.-No.	Größe Size	Dimension (außen) Dimension (outside) (mm)
80-631-10	1/2	297 x 274 x 88
80-631-12	1/2	297 x 274 x 123
80-631-14	1/2	297 x 274 x 138
80-631-21	1/2	297 x 274 x 188
80-641-14	3/4	462 x 274 x 138
80-661-12	1	585 x 274 x 123
80-661-14	1	585 x 274 x 138
80-661-21	1	585 x 274 x 188



Ventildeckel für Norm-Sterilisations-Container

Valve lid for norm sterilization container

Art.-Nr./No.	Art.-Nr./No.	Art.-Nr./No.
1/2	3/4	1
299 x 278 mm	462 x 278 mm	585 x 278 mm
80-632-00	80-642-00	80-662-00
80-632-01	80-642-01	80-662-01
80-632-02	80-642-02	80-662-02
80-632-03	80-642-03	80-662-03
80-632-04	80-642-04	80-662-04
80-632-05	80-642-05	80-662-05

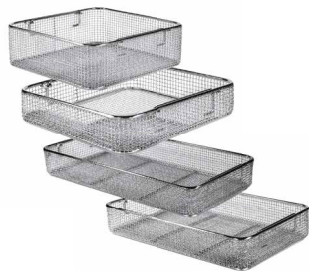

Edelstahl-Siebkorb, Geflecht, Fallgriffe

Stainless-steel wire basket, sliding handles

Art.-Nr./No.	Größe / Size (mm)
80-671-20	255 x 245 x 50
80-671-25	255 x 245 x 70
80-671-40	405 x 255 x 70
80-671-60	485 x 255 x 70



Aluminium-Kennzeichnungsschild, 20 Zeichen, 56 x 17 mm

Coding label, 20 letters, 56 x 17 mm

Art.-Nr./No.	Farbe / Color
80-681-01	schwarz / black
80-681-02	rot / red
80-681-03	braun / brown
80-681-04	grün / green
80-681-05	gelb / yellow
80-681-06	lila / purple
80-681-07	blau / blue

Einweg-Container-Siegel, blau, 100 Stück/Box

Container seal, disposable, blue, 100 pieces/box

80-683-10

Indikator-Klebe-Etikett, Lasche rechts, 100 Stück/Box

Adhesive indicator label, latch right side, 100 pieces/box

80-684-10

Klemmschild aus Edelstahl, hitzebeständig,

6 x 4 cm, 25 Stück/Box

Label holder with clip, stainless steel, heat resistant,

6 x 4 cm, 25 pieces/box

80-688-00



08 Tonsillektomie/Adenotomie-Set

Tonsillectomy/Adenotomy set

Bestehend aus / Consisting of:

- 20-254-03 Schmeden Conchotom, Größe 3, dreieckig, 10 mm, 12 cm
Schmeden cutting forceps, size 3, triangular, 10 mm, 12 cm
- 20-615-18 Metzenbaum Schere, Hartmetall, gebogen, stumpf-stumpf, fein 18 cm
Metzenbaum scissors, tungsten carbide, curved, blunt, fine, 18 cm
- 40-200-00 Beckmann Ringmesser, Größe 0, gerade, 10,5 mm, 22 cm
Beckmann adenoid curette, size 0, straight, 10.5 mm, 22 cm
- 40-200-01 Beckmann Ringmesser, Größe 1, gerade, 13 mm, 22 cm
Beckmann adenoid curette, size 1, straight, 13 mm, 22 cm
- 40-200-02 Beckmann Ringmesser, Größe 2, gerade, 14,5 mm, 22 cm
Beckmann adenoid curette, size 2, straight, 14.5 mm, 22 cm
- 40-200-03 Beckmann Ringmesser, Größe 3, gerade, 16,5 mm, 22,5 cm
Beckmann adenoid curette, size 3, straight, 16.5 mm, 22.5 cm
- 40-220-02 Jatho Nasenrachenzange, 70° aufgebogen, horizontal öffnend, Rohrschaft, Spülkanal, AL 15 cm / Jatho epipharyngeal forceps, 70° curved upwards, horizontal opening, tubular model, irrig. channel, wl 15 cm
- 40-225-00 Jurasz Nasenrachenzange 19 cm / Jurasz adenoid forceps 19 cm
- 40-230-21 Nager Gaumensegelhaken 22 cm / Nager pillar retractor 22 cm
- 40-300-02 Davis-Meyer Mundsperrer, links offen, verschiebbare Zahnhaken
Davis-Meyer mouth gag, left side open, movable teeth hooks
- 40-318-01 Russel-Davis Zungenspatel mit Rinne, Ausgang links, Größe 1, 30x70 mm / Russel-Davis tongue depressor with, central channel, outlet left side, size 1, 30x70 mm
- 40-318-02 Russel-Davis Zungenspatel mit Rinne, Ausgang links, Größe 2, 34x80 mm / Russel-Davis tongue depressor with, central channel, outlet left side, size 2, 34x80 mm
- 40-318-03 Russel-Davis Zungenspatel mit Rinne, Ausgang links, Größe 3, 39x85 mm / Russel-Davis tongue depressor with, central channel, outlet left side, size 3, 39x85 mm
- 40-318-04 Russel-Davis Zungenspatel mit Rinne, Ausgang links, Größe 4, 42x98 mm / Russel-Davis tongue depressor with, central channel, outlet left side, size 4, 42x98 mm
- 40-355-28 Brünings Tonsillenschnürer 29 cm / Brünings tonsil snare 29 cm
- 40-359-27 Roeder Ligatur-Instrument, Form E, für Vicryl-Faden 27 cm
Roeder ligature instrument, form E, for vicryle wire 27 cm
- 40-381-15 Henke Raspatorium/Dissektor, breit, 15 mm, 24 cm
Henke raspatory/dissector, large, 15 mm, 24 cm
- 40-390-21 Blohmke Fasszange, gebogen, 20 cm
Blohmke tonsil forceps, curved, 20 cm
- 40-406-20 Tonsillen-Pinzette, 1:2 Zähne, breit, 2,5 mm, 20,5 cm
Tonsil dissecting forceps, 1:2 teeth, large, 2.5 mm, 20.5 cm
- 40-420-29 Yankauer Saugrohr, für Erwachsene, 6 mm, abschraubbarer Ansatz, Öffnung 3 mm, 28,5 cm / Yankauer Suction tube, for adults, 6 mm, detachable tip, opening 3 mm, 28.5 cm
- 40-430-19 Good-Schweckendiek Tonsillenschere, gebogen, gezahnt, 19,5 cm
Good-Schweckendiek tonsil scissors, curved, serrated, 19.5 cm
- 40-450-19 Schnidt Tonsillenklemme, einseitig offener Ring, schlank, leicht gebogen, 19 cm / Schnidt tonsil forceps, one ring open, slender, slightly curved, 19 cm
- 40-457-19 Negus Tonsillenklemme, schlank, stark gebogen, 20 cm
Negus tonsil forceps, slender, wide curve, 20 cm
- 40-465-18 Crile-Wood Nadelhalter, schlank, Hartmetall, 18 cm
Crile-Wood needle holder, slender, tungsten carbide, 18 cm
- 40-500-19 Brünings Zungenspatel, gefenstert, 19 cm
Brünings tongue depressor, fenestrated, 19 cm
- 40-520-00 Griff für Kehlkopfspiegel, Zentralverschraubung, 11 cm
Handle for laryngeal mirrors, central screw, 11 cm
- 40-524-02 Kehlkopfspiegel, Rhodium beschichtet, ohne Griff, ohne Gewinde, Gr. 2, 14,5 cm / Laryngeal mirror, rhodium coated, without handle, without screw, size 2, 14.5 cm
- 40-524-06 Kehlkopfspiegel, Rhodium beschichtet, ohne Griff, ohne Gewinde, Gr. 6, 22 cm / Laryngeal mirror, rhodium coated, without handle, without screw, size 6, 22 cm
- 40-553-02 Injektionskanüle, bajonett, Luer-Lock, 0,8 mm, AL 8,5 cm, GL 13 cm
Injection needle bayonet, luer-lock, 0.8 mm, wl 8.5 cm, TL 13 cm
- 80-106-19 Bipolare Pinzette, NON-STICK, gerade, Spitze gewinkelt, Spitze 8mm lang, 1,0 mm breit, Führungsstift, 19,5 cm
Bipolar forceps, NON-STICK, straight, angled tip, tip length 8 mm, 1.0 mm wide, guide pin, 19.5 cm
- 80-318-50 Bipolares Anschlusskabel passend für Erbe/Storz/Wolf 5 m
Bipolar connecting cable compatible with Erbe/Storz/Wolf 5 m
- 80-392-09 6x Backhaus Tuchklemme, gebogen, scharf, 9 cm
6x Backhaus towel clamp, curved, sharp, 9 cm
- 80-501-03 Metallschale, B4, Ø 85 mm, Höhe 40 mm, 160 ml
Metal bowl, B4, Ø 85 mm, height 40 mm, 160 ml
- 80-504-05 Medizinbecher, graduiert, 50 ml / Medical cup, graduated, 50 ml
- 40-554-13 Kehlkopfkanüle, gebogen, Luer-Lock, 2,7 mm, 13 cm
Laryngeal cannula, curved, Luer-lock, 2.7 mm, 13 cm
- 80-661-14 Norm-Sterilisations-Container Boden geschlossen, 585x274x138 mm
Maße mit Deckel: 585x278x155 mm / Norm sterilization container bottom closed, 585x274x138 mm, dimensions with fitted lid: 585x278x155mm
- 80-662-00 Ventildeckel silber, für Container 80-661-14 585x278 mm
Valve lid silver, for container 80-661-xx, 585x278 mm
- 80-671-60 Edelstahl-Siebkorb Geflecht, Fallgriffe 485x255x70 mm
Stainless steel wire basket, sliding handles 485x255x70 mm
- 80-681-03 Aluminium-Kennzeichnungs-Schild braun, 20 Zeichen 56x17 mm
Aluminium tag brown, 20 letters, 56x17 mm

Ergänzung

Supplement

Supplement for sales in EU (outside the EU only on request)

Bestehend aus / Consisting of:

- 20-254-03 Schmeden Conchotom, Größe 3, dreieckig, 10 mm, 12 cm
Schmeden cutting forceps, size 3, triangular, 10 mm, 12 cm
- 20-615-18 Metzenbaum Schere, Hartmetall, gebogen, stumpf-stumpf, fein 18 cm
Metzenbaum scissors, tungsten carbide, curved, blunt, fine, 18 cm
- 40-200-00 Beckmann Ringmesser, Größe 0, gerade, 10,5 mm, 22 cm
Beckmann adenoid curette, size 0, straight, 10.5 mm, 22 cm
- 40-200-01 Beckmann Ringmesser, Größe 1, gerade, 13 mm, 22 cm
Beckmann adenoid curette, size 1, straight, 13 mm, 22 cm
- 40-200-02 Beckmann Ringmesser, Größe 2, gerade, 14,5 mm, 22 cm
Beckmann adenoid curette, size 2, straight, 14.5 mm, 22 cm
- 40-200-03 Beckmann Ringmesser, Größe 3, gerade, 16,5 mm, 22,5 cm
Beckmann adenoid curette, size 3, straight, 16.5 mm, 22.5 cm
- 40-220-02 Jatho Nasenrachenzange, 70° aufgebogen, horizontal öffnend,
Rohrschaft, Spülkanal, AL 15 cm / Jatho epipharyngeal forceps,
70° curved upwards, horizontal opening, tubular model,
irrig. channel, wl 15 cm
- 40-225-00 Jurasz Nasenrachenzange 19 cm / Jurasz adenoid forceps 19 cm
- 40-230-21 Nager Gaumensegelhaken 22 cm / Nager pillar retractor 22 cm
- 40-300-02 Davis-Meyer Mundsperrer, links offen, verschiebbare Zahnhaken
Davis-Meyer mouth gag, left side open, movable teeth hooks
- 40-310-01 Mclvor Zungenspatel, glatt, Gr. 1, 23x75 mm
Mclvor tongue depressor, smooth, size 1, 23x75 mm
- 40-310-02 Mclvor Zungenspatel, glatt, Gr. 2, 25x91 mm
Mclvor tongue depressor, smooth, size 2, 25x91 mm
- 40-310-03 Mclvor Zungenspatel, glatt, Gr. 3, 26x103 mm
Mclvor tongue depressor, smooth, size 3, 26x103 mm
- 40-420-29 Yankauer Saugrohr, für Erwachsene, 6 mm, abschraubbarer
Ansatz, Öffnung 3 mm, 28,5 cm / Yankauer Suction tube,
for adults, 6 mm, detachable tip, opening 3 mm, 28.5 cm
- 40-500-19 Brünings Zungenspatel, gefenstert, 19 cm
Brünings tongue depressor, fenestrated, 19 cm
- 40-520-00 Griff für Kehlkopfspiegel, Zentralverschraubung, 11 cm
Handle for laryngeal mirrors, central screw, 11 cm
- 40-524-02 Kehlkopfspiegel, Rhodium beschichtet, ohne Griff,
ohne Gewinde, Gr. 2, 14,5 cm / Laryngeal mirror, rhodium
coated, without handle, without screw, size 2, 14.5 cm
- 40-524-06 Kehlkopfspiegel, Rhodium beschichtet, ohne Griff,
ohne Gewinde, Gr. 6, 22 cm / Laryngeal mirror, rhodium
coated, without handle, without screw, size 6, 22 cm
- 80-121-18 Meuser bipolare Pinzette, NON-STICK, 60° gebogen,
Spitze 8 mm lang, 2,0 mm, breit, Auflagestift, 18 cm
Meuser Bipolar forceps NON-STICK, 60° curved, tip length
8 mm, 2.0 mm wide, pin, 18 cm
- 80-318-50 Bipolares Anschlusskabel passend für Erbe/Storz/Wolf 5 m
Bipolar connecting cable compatible with Erbe/Storz/Wolf 5 m
- 80-501-03 Metallschale, B4, Ø 85 mm, Höhe 40 mm, 160 ml
Metal bowl, B4, Ø 85 mm, height 40 mm, 160 ml
- 80-504-05 2x Medizinbecher, graduert, 50 ml
2x Medical cup, graduated, 50 ml

Ergänzung**Supplement**

- 80-631-14 Norm-Sterilisations-Container Boden geschlossen,
297x274x138 mm Maße mit Deckel: 585x278x155 mm
Norm sterilization container, bottom closed, 297x274x138 mm,
dimensions with fitted lid: 299x278x155mm
- 80-632-00 Ventildeckel silber, für Container 80-631-14, 299x278 mm
Valve lid, silver, for container 80-631-xx, 299x278 mm
- 80-671-20 Edelstahl-Siebkorb, Geflecht, Fallgriffe, 255 x 245 x 50 mm
Stainless steel wire basket, sliding handles, 255 x 245 x 50 mm
- 80-681-02 Aluminium-Kennzeichnungs-Schild, rot, 20 Zeichen, 56 x 17 mm
Aluminium tag, red, 20 letter, 56 x 17 mm

[Supplement for sales in EU \(outside the EU only on request\)](#)



08 Tracheotomie-Set

Tracheotomy set

Bestehend aus / Consisting of:

- 10-356-00 Wullstein Raspatorium, 4 mm breit, 16,5 cm
Wullstein raspatory, 4 mm wide, 16.5 cm
- 10-360-03 Skalpellgriff, Nr. 3, 12,5 cm
Scalpell handle, no. 3, 12.5 cm
- 10-360-04 Skalpellgriff, Nr. 4, 13,5 cm
Scalpell handle, no. 4, 13.5 cm
- 10-438-17 2x Fisch Wundsperrer, mit Gelenken, 3:3 Zähne, halbscharf, zerlegbar, 16,5 cm
2x Fisch retractor, with joints, 3:3 prongs, semi-sharp, dismountable, 16.5 cm
- 10-481-14 Pinzette, chirurgisch, anatomisch, gerade, 2 mm, 14,5 cm
Dressing forceps, anatomical, straight, 2 mm, 14.5 cm
- 10-482-14 Pinzette, chirurgisch, anatomisch, gerade, 1,7 mm, 14,5 cm
Dressing forceps, anatomical, straight, 1.7 mm, 14.5 cm
- 10-483-14 3x Pinzette, chirurgisch, 1:2 Zähne, gerade, 2,3 mm, 14,5 cm
3x Dressing forceps, 1:2 teeth, straight, 2.3 mm, 14.5 cm
- 10-484-14 2x Pinzette, chirurgisch, 1:2 Zähne, gerade, 1,7 mm, 14,5 cm
2x Dressing forceps, 1:2 teeth, straight, 1.7 mm, 14.5 cm
- 20-100-01 Hartmann Nasenspekulum, für Erwachsene, zerlegbar
Hartmann nasal speculum, for adults, dismountable
- 20-305-18 Freer Doppelelevatorium, scharf/stumpf, 18,5 cm
Freer elevator, double ended, sharp/blunt, 18.5 cm
- 20-610-15 Reynolds Schere, stumpf-stumpf, gebogen, verjüngte Spitzen, 16 cm
Reynolds scissors, blunt, curved, tapered tips, 16 cm
- 20-615-15 Metzenbaum Schere, Hartmetall, gebogen, stumpf-stumpf, fein, 14,5 cm
Metzenbaum scissors, tungsten carbide, curved, blunt, fine, 14.5 cm
- 20-615-18 Metzenbaum Schere, Hartmetall, gebogen, stumpf-stumpf, fein, 18 cm
Metzenbaum scissors, tungsten carbide, curved, blunt, fine, 18 cm
- 20-740-15 Crile-Wood Nadelhalter, Hartmetall, 15 cm
Crile-Wood needle holder, tungsten carbide, 15 cm
- 30-490-40 Hajek-Kofler Keilbeinstanze, aufeinander schneidend, 90° aufwärts, 4 mm, 14 cm, komplett zerlegbar
Hajek-Kofler sphenoid punch, 90° curved upwards, 4 mm, 14 cm, totally detachable
- 40-465-18 Crile-Wood Nadelhalter, schlank, Hartmetall, 18 cm
Crile-Wood needle holder, slender, tungsten carbide, 18 cm
- 40-475-26 Gross-Maier Kornzange, gebogen, 26 cm
Gross-Maier sponge forceps, curved, 26 cm
- 40-508-18 Buchwald Zungenspatel, 19/23 mm, 18 cm
Buchwald tongue depressor, 19/23 mm, 18 cm
- 80-105-16 Bipolare Pinzette, NON-STICK, gerade, Spitze gewinkelt, Spitze 8mm lang, 0,5 mm breit, Führungsstift, 16 cm
Bipolar forceps, NON-STICK, straight, angled tip, tip length 8 mm, 0.5 mm wide, guide pin, 16 cm
- 80-107-19 Bipolare Pinzette, NON-STICK, gerade, Spitze gewinkelt, Spitze 8mm lang, 2,0 mm breit, Führungsstift, 19,5 cm
Bipolar forceps, NON-STICK, straight, angled tip, tip length 8 mm, 2.0 mm wide, guide pin, 19.5 cm
- 80-308-10 2x Kocher-Langenbeck Wundhaken, Ringgriff, 36x10 mm, 22 cm
2x Kocher-Langenbeck retractor, ring handle, 36x10 mm, 22 cm
- 80-308-15 2x Kocher-Langenbeck Wundhaken, Ringgriff, 35x15 mm, 22 cm
2x Kocher-Langenbeck retractor, ring handle, 35x15 mm, 22 cm
- 80-308-20 2x Kocher-Langenbeck Wundhaken, Ringgriff, 61x20 mm, 23 cm
2x Kocher-Langenbeck retractor, ring handle, 61x20 mm, 23 cm
- 80-312-21 Schönborn Schilddrüsenhaken, 6,5x13 mm, 20,5 cm
Schönborn retractor, 6.5x13 mm, 20.5 cm
- 80-315-16 2x Senn-Miller Wundhaken, doppelendig, 3 Zähne, scharf, 16,5 cm
2x Senn-Miller retractor, double ended, 3 teeth, sharp, 16.5 cm
- 80-318-50 Bipolares Anschlusskabel passend für Erbe/Storz/Wolf 5 m
Bipolar connecting cable compatible with Erbe/Storz/Wolf 5 m
- 80-330-04 2x Volkmann Wundhaken, scharf, 4-zinkig, Ringgriff, 23 cm
2x Volkmann retractor, sharp, 4 prongs, ring handle, 23 cm
- 80-350-02 6x Halsted-Mosquito-Klemme, gebogen, anatomisch, 12,5 cm
6x Halsted-Mosquito artery forceps, curved, anatomical, 12.5 cm
- 80-354-02 6x Halsted-Mosquito-Klemme, gebogen, anatomisch, 18,5 cm
6x Halsted-Mosquito artery forceps, curved, anatomical, 18.5 cm
- 80-365-16 2x Pean Arterienklemme, gerade, anatomisch, fein, 16,5 cm
2x Pean artery forceps, straight, anatomical, fine, 16.5 cm
- 80-370-16 4x Kocher Arterienklemme, gerade, chirurgisch, fein, 16 cm
4x Kocher artery forceps, straight, 1:2 teeth, fine, 16 cm
- 80-383-22 2x Rochester-Pean Arterienklemme, gebogen, anatomisch, 22 cm
2x Rochester-Pean artery forceps, curved, anatomical, 22 cm
- 80-394-13 2x Edna-Lorna Tuchklemme, gerade, stumpf, für Papier-Tücher, 13,5 cm
2x Edna-Lorna towel clamp, straight, blunt, for paper towels, 13.5 cm
- 80-448-15 2x Cooper Schere, gebogen, spitz-stumpf, 14,5 cm
2x Cooper scissors, curved, sharp-blunt, 14.5 cm
- 80-478-14 Laborde Trachealdilatator, 3-armig, 15 cm
Laborde tracheal dilator, 3 prongs, 15 cm
- 80-482-19 Weerda Trachealspekulum, 19 cm
Weerda tracheal speculum, 19 cm
- 80-501-02 Metallschale, B2, Ø 60 mm, Höhe 29 mm, 60 ml
Metal bowl, B2, Ø 60 mm, height 29 mm, 60 ml
- 80-501-04 Metallschale, B6, Ø 110 mm, Höhe 55 mm, 400 ml
Metal bowl, B6, Ø 110 mm, height 55 mm, 400 ml
- 80-525-25 2x Nierenschale, Edelstahl, 250 mm
2x Kidney bowl, stainless steel, 250 mm

Ergänzung

Supplement

- 80-631-14 Norm-Sterilisations-Container Boden geschlossen, 297x274x138 mm Maße mit Deckel: 585x278x155 mm
Norm sterilization container, bottom closed, 297x274x138 mm, dimensions with fitted lid: 299x278x155mm
- 80-632-00 Ventildeckel silber, für Container 80-631-14, 299x278 mm
Valve lid, silver, for container 80-631-xx, 299x278 mm
- 80-671-20 Edelstahl-Siebkorb, Geflecht, Fallgriffe, 255 x 245 x 50 mm
Stainless steel wire basket, sliding handles, 255 x 245 x 50 mm
- 80-681-07 Aluminium-Kennzeichnungs-Schild, blau, 20 Zeichen, 56 x 17 mm
Aluminium tag, blau, 20 letter, 56 x 17 mm

Supplement for sales in EU (outside the EU only on request)

Bestehend aus / Consisting of:

- 06-0741 AV 2x Overholt-Geissendoerfer Ligaturklemme, gebogen, 19,5 cm
2x Overholt-Geissendoerfer ligature forceps, curved, 19.5 cm
- 10-356-00 Wullstein Raspatorium, 4 mm breit, 16,5 cm
Wullstein raspatory, 4 mm wide, 16.5 cm
- 10-360-03 Skalpellgriff, Nr. 3, 12,5 cm / Scalpell handle, no. 3, 12.5 cm
- 10-360-04 Skalpellgriff, Nr. 4, 13,5 cm / Scalpell handle, no. 4, 13.5 cm
- 10-438-17 Fisch Wundsperrer, mit Gelenken, 3:3 Zähne, halbscharf, zerlegbar, 16,5 cm / Fisch retractor, with joints, 3:3 prongs, semi-sharp, dismountable, 16.5 cm
- 10-446-11 Preyer Wundsperrer, schmales Blatt, beidseits mit Noppen, Griff vergoldet, zerlegbar, 11 cm / Preyer retractor, slim blade, studded on both sides, gold plated grip, dismountable, 11 cm
- 10-481-14 2x Pinzette, chirurgisch, anatomisch, gerade, 2 mm, 14,5 cm
2x Dressing forceps, anatomical, straight, 2 mm, 14.5 cm
- 10-484-14 2x Pinzette, chirurgisch, 1:2 Zähne, gerade, 1,7 mm, 14,5 cm
2x Dressing forceps, 1:2 teeth, straight, 1.7 mm, 14.5 cm
- 10-487-16 2x DeBakey Pinzette, atraumatisch, gerade, 1,5 mm, 15,5 cm
2x DeBakey dressing forceps, atraumatic, straight, 1.5 mm, 15.5 cm
- 20-150-55 Killian-Struycken Septumspekulum, 55 mm, 14 cm
Killian-Struycken septum speculum, 55 mm, 14 cm
- 20-153-75 Cottle Septumspekulum, extra dünne Blätter, schwarz, mit Stellschraube, 75 mm, 13 cm / Cottle septum speculum, extra thin blades, black, with screw, 75 mm, 13 cm
- 20-305-18 Freer Doppellevatorium, scharf/stumpf, 18,5 cm
Freer elevator, double ended, sharp/blunt, 18.5 cm
- 20-614-18 Metzenbaum Schere, gebogen, stumpf-stumpf, fein, 18 cm
Metzenbaum scissors, curved, blunt, fine, 18 cm
- 20-615-15 Metzenbaum Schere, Hartmetall, gebogen, stumpf-stumpf, fein, 14,5 cm
Metzenbaum scissors, tungsten carbide, curved, blunt, fine, 14.5 cm
- 20-730-16 2x Jansen Nasenpinzette, anatomisch, bajonett, 2,0 mm, 16 cm
2x Jansen dressing forceps, anatomical, bayonet, 2.0 mm, 16 cm
- 20-740-15 Crile-Wood Nadelhalter, Hartmetall, 15 cm
Crile-Wood needle holder, tungsten carbide, 15 cm
- 30-080-10 Frazier Saugrohr, mit Griffplatte und Unterbrecher, 10 CH, 9 cm
Frazier suction tube, with suction control, 10 FR, 9 cm
- 30-080-12 Frazier Saugrohr, mit Griffplatte und Unterbrecher, 12 CH, 9 cm
Frazier suction tube, with suction control, 12 FR, 9 cm
- 40-405-20 2x Tonsillen-Pinzette, 1:2 Zähne, fein, 2 mm, 20,5 cm
2x Tonsil dissecting forceps, 1:2 teeth, fine, 2 mm, 20.5 cm
- 40-450-19 2x Schnidt Tonsillenklemme, einseitig offener Ring, schlank, leicht gebogen, 19 cm / 2x Schnidt tonsil forceps, one ring open, slender, slightly curved, 19 cm
- 40-465-18 Crile-Wood Nadelhalter, schlank, Hartmetall, 18 cm
Crile-Wood needle holder, slender, tungsten carbide, 18 cm
- 80-107-19 Bipolare Pinzette, NON-STICK, gerade, Spitze gewinkelt, Spitze 8mm lang, 2,0 mm breit, Führungsstift, 19,5 cm
Bipolar forceps, NON-STICK, straight, angled tip, tip length 8 mm, 2.0 mm wide, guide pin, 19.5 cm
- 80-309-51 2x Langenbeck Wundhaken, Ringgriff, 51x11 mm, 21 cm
2x Langenbeck retractor, ring handle, 51x11 mm, 21 cm
- 80-317-00 2x Baby-Roux Haken, doppelendig, 16x16 und 21x19 mm, 13,5 cm
2x Baby-Roux retractor, double ended, 16x16 and 21x19 mm, 13.5 cm
- 80-318-50 Bipolares Anschlusskabel passend für Erbe/Storz/Wolf 5 m
Bipolar connecting cable compatible with Erbe/Storz/Wolf 5 m
- 80-330-03 2x Volkmann Wundhaken, scharf, 3-zinkig, Ringgriff, 23 cm
2x Volkmann retractor, sharp, 3 prongs, ring handle, 23 cm
- 80-340-01 2x Trachealhäkchen, scharf, 1-zinkig, glatter Griff, 17 cm
2x Trachea hook, sharp, 1 prong, flat handle, 17 cm
- 80-350-01 8x Halsted-Mosquito-Klemme, gerade, anatomisch, 12,5 cm
8x Halsted-Mosquito artery forceps, straight, anatomical, 12.5 cm
- 80-350-02 8x Halsted-Mosquito-Klemme, gebogen, anatomisch, 12,5 cm
8x Halsted-Mosquito artery forceps, curved, anatomical, 12.5 cm
- 80-360-14 2x Präparierklemme, leicht gebogen, anatomisch, ohne Sperre, 14,5 cm
2x Artery Forceps, slightly curved, anatomical, without, ratchet, 14.5 cm
- 80-365-14 4x Pean Arterienklemme, gerade, anatomisch, fein, 14 cm
4x Pean artery forceps, straight, anatomical, fine, 14 cm
- 80-370-14 4x Kocher Arterienklemme, gerade, chirurgisch, fein, 14 cm
4x Kocher artery forceps, straight, 1:2 teeth, fine, 14 cm
- 80-442-15 Cooper Schere, gerade, spitz-stumpf, 14,5 cm
Cooper scissors, straight, sharp-blunt, 14.5 cm
- 80-478-14 Laborde Trachealdilatator, 3-armig, 15 cm
Laborde tracheal dilator, 3 prongs, 15 cm
- 80-482-19 Weerda Trachealspekulum, 19 cm
Weerda tracheal speculum, 19 cm
- 80-501-03 Metallschale, B4, Ø 85 mm, Höhe 40 mm, 160 ml
Metal bowl, B4, Ø 85 mm, height 40 mm, 160 ml
- 80-501-04 Metallschale, B6, Ø 110 mm, Höhe 55 mm, 400 ml
Metal bowl, B6, Ø 110 mm, height 55 mm, 400 ml
- 80-525-25 Nierenschale, Edelstahl, 250 mm
Kidney bowl, stainless steel, 250 mm

Ergänzung**Supplement**

- 80-631-14 Norm-Sterilisations-Container Boden geschlossen, 297x274x138 mm Maße mit Deckel: 585x278x155 mm
Norm sterilization container, bottom closed, 297x274x138 mm, dimensions with fitted lid: 299x278x155mm
- 80-632-00 Ventildeckel silber, für Container 80-631-14, 299x278 mm
Valve lid, silver, for container 80-631-xx, 299x278 mm
- 80-671-20 Edelstahl-Siebkorb, Geflecht, Fallgriffe, 255 x 245 x 50 mm
Stainless steel wire basket, sliding handles, 255 x 245 x 50 mm
- 80-681-07 Aluminium-Kennzeichnungs-Schild, blau, 20 Zeichen, 56 x 17 mm
Aluminium tag, blau, 20 letter, 56 x 17 mm

Supplement for sales in EU (outside the EU only on request)



Neck dissection basic set

Bestehend aus / Consisting of:

- 10-534-12 Schere, supercut, gebogen, spitz-spitz, 11,5 cm
Scissors, supercut, curved, pointed, 11.5 cm
- 10-352-14 Cottle Raspatorium, gebogen, 14 mm, 19,5 cm
Cottle raspatory, curved, 14 mm, 19.5 cm
- 10-360-03 Skalpellgriff, Nr. 3, 12,5 cm / Scalpell handle, no. 3, 12.5 cm
- 10-360-07 Skalpellgriff, Nr. 7, 16 cm / Scalpell handle, no. 7, 16 cm
- 10-435-15 Mollison Wundsperrer, 4:4 Zähne, scharf, zerlegbar, 15,5 cm
Mollison retractor, 4:4 prongs, sharp, dismountable, 15.5 cm
- 10-438-17 Fisch Wundsperrer, mit Gelenken, 3:3 Zähne, halbscharf, zerlegbar, 16,5 cm / Fisch retractor, with joints, 3:3 prongs, semi-sharp, dismountable, 16.5 cm
- 10-481-14 Pinzette, chirurgisch, anatomisch, gerade, 2 mm, 14,5 cm
Dressing forceps, anatomical, straight, 2 mm, 14.5 cm
- 10-482-14 Pinzette, chirurgisch, anatomisch, gerade, 1,7 mm, 14,5 cm
Dressing forceps, anatomical, straight, 1.7 mm, 14.5 cm
- 10-484-14 2x Pinzette, chirurgisch, 1:2 Zähne, gerade, 1,7 mm, 14,5 cm
2x Dressing forceps, 1:2 teeth, straight, 1.7 mm, 14.5 cm
- 10-485-14 2x Pinzette, chirurgisch, 1:2 Zähne, gerade, 1,4 mm, 14,5 cm
2x Dressing forceps, 1:2 teeth, straight, 1.4 mm, 14.5 cm
- 10-486-14 DeBaKey Pinzette, atraumatisch, gerade, 2,0 mm, 15 cm
DeBaKey dressing forceps, atraumatic, straight, 2.0 mm, 15 cm
- 10-496-12 Adson Pinzette, Hartmetall, anatomisch, 12,5 cm
Adson dressing forceps, tungsten carbide, anatomical, 12.5 cm
- 20-150-75 Killian-Struycken Septumspekulum, 75 mm, 14 cm
Killian-Struycken septum speculum, 75 mm, 14 cm
- 20-252-03 Hartmann Conchotom, Größe 3, rund, 9 mm, 12 cm
Hartmann cutting forceps, size 3, round, 9 mm, 12 cm
- 20-306-20 Freer Doppellevatorium, scharf/stumpf, 20 cm
Freer double ended elevator, sharp/blunt, 20 cm
- 20-309-20 Killian Raspatorium, doppelseitig, scharf/stumpf, 23,5 cm
Killian raspatory, double ended, sharp/blunt, 23.5 cm
- 20-582-10 2x Joseph Doppel-Häkchen, 2-zinkig, scharf, 10 mm, 16 cm
2x Joseph double hook, 2 prongs, sharp, 10 mm, 16 cm
- 20-601-14 2x Joseph Schere, gebogen, spitz-spitz, 14,5 cm
2x Joseph scissors, curved, pointed, 14.5 cm
- 20-610-15 Reynolds Schere, stumpf-stumpf, gebogen, verjüngte Spitzen, 16 cm / Reynolds scissors, blunt, curved, tapered tips, 16 cm
- 20-615-15 2x Metzenbaum Schere, Hartmetall, gebogen, stumpf-stumpf, fein, 14,5 cm / 2x Metzenbaum scissors, tungsten carbide, curved, blunt, fine, 14.5 cm
- 20-615-18 2x Metzenbaum Schere, Hartmetall, gebogen, stumpf-stumpf, fein, 18 cm / 2x Metzenbaum scissors, tungsten carbide, curved, blunt, fine, 18 cm
- 20-624-11 Stevens Gefäßschere, verjüngte Spitzen, gebogen, 11,5 cm
Stevens vascular scissors, small tips, blunt, curved, 11.5 cm
- 20-710-12 Adson-Brown Pinzette, 7:8 Zähne, 12,5 cm
Adson-Brown forceps, 7:8 teeth, 12.5 cm
- 20-712-12 Adson Pinzette, chirurgisch, 1:2 Zähne, 12 cm
Adson dressing forceps, 1:2 teeth, 12 cm
- 20-730-16 2x Jansen Nasenpinzette / 2x Jansen nasal forceps
- 20-740-15 Crile-Wood Nadelhalter, Hartmetall, 15 cm
Crile-Wood needle holder, tungsten carbide, 15 cm
- 20-744-17 Senning Nadelhalter, Hartmetall, extra schlank, 17 cm
Senning needle holder, tungsten carbide, slender shape, 17 cm
- 25-589-01 2x Einzinker, groß / 2x Hook, one prong, large
- 30-080-09 Frazier Saugrohr, mit Griffplatte und Unterbrecher, 9 CH, 9 cm
Frazier suction tube, with suction control, 9 FR, 9 cm
- 30-080-12 Frazier Saugrohr, mit Griffplatte und Unterbrecher, 12 CH, 9 cm
Frazier suction tube, with suction control, 12 FR, 9 cm
- 30-080-15 Frazier Saugrohr, mit Griffplatte und Unterbrecher, 15 CH, 9 cm
Frazier suction tube, with suction control, 15 FR, 9 cm
- 40-381-12 Henke Raspatorium/Dissektor, schmal, 12 mm, 23,5 cm
Henke raspatory/dissector, small, 12 mm, 23.5 cm
- 40-400-20 Tonsillen-Pinzette, gerieft, fein, 2,2 mm, 20 cm
Tonsil dressing forceps, serrated, small, 2.2 mm, 20 cm
- 40-405-20 Tonsillen-Pinzette, 1:2 Zähne, fein, 2 mm, 20,5 cm
Tonsil dissecting forceps, 1:2 teeth, fine, 2 mm, 20.5 cm
- 40-420-29 Yankauer Saugrohr, für Erwachsene, 6 mm, abschraubbarer Ansatz, Öffnung 3 mm, 28,5 cm / Yankauer Suction tube, for adults, 6 mm, detachable tip, opening 3 mm, 28.5 cm
- 40-441-18 Toennis-Adson Tonsillenschere, supercut, gebogen, stumpf, extra fein, 17,5 cm / Toennis-Adson tonsil scissors, supercut, curved, blunt, very fine, 17.5 cm
- 40-450-19 6x SchnidT Tonsillenklemme, einseitig offener Ring, schlank, leicht gebogen, 19 cm / 6x SchnidT tonsil forceps, one ring open, slender, slightly curved, 19 cm
- 40-455-20 2x Birkett Tonsillenklemme, schlank, gebogen, 20 cm
2x Birkett tonsil forceps, slender, curved, 20 cm
- 40-457-19 2x Negus Tonsillenklemme, schlank, stark gebogen, 20 cm
2x Negus tonsil forceps, slender, wide curve, 20 cm
- 40-462-18 2x Mikulicz Tonsillenklemme, gebogen, 1:2 Zähne, 18,5 cm
2x Mikulicz tonsil forceps, curved, 1:2 teeth, 18.5 cm
- 40-465-18 Crile-Wood Nadelhalter, schlank, Hartmetall, 18 cm
Crile-Wood needle holder, slender, tungsten carbide, 18 cm
- 40-474-20 Gross Kornzange, gebogen, 20 cm
Gross sponge forceps, curved, 20 cm
- 40-500-19 Brünings Zungenspatel, gefenstert, 19 cm
Brünings tongue depressor, fenestrated, 19 cm
- 80-112-19 Bipolare Pinzette, NON-STICK, bajonett, Spitze 8 mm lang, 2,0 mm breit, Führungsstift, 19,5 cm
Bipolar forceps, NON-STICK, bayonet, tip length 8 mm, 2.0 mm wide, guide pin, 19.5 cm
- 80-308-07 2x Kocher-Langenbeck Wundhaken, Ringgriff, 35x7 mm, 21 cm
2x Kocher-Langenbeck retractor, ring handle, 35x7 mm, 21 cm
- 80-308-15 2x Kocher-Langenbeck Wundhaken, Ringgriff, 35x15 mm, 22 cm
2x Kocher-Langenbeck retractor, ring handle, 35x15 mm, 22 cm
- 80-308-20 2x Kocher-Langenbeck Wundhaken, Ringgriff, 61x20 mm, 23 cm
2x Kocher-Langenbeck retractor, ring handle, 61x20 mm, 23 cm
- 80-312-21 2x Schönborn Schilddrüsenhaken, 6,5x13 mm, 20,5 cm
2x Schönborn retractor, 6.5x13 mm, 20.5 cm
- 80-318-50 Bipolares Anschlusskabel passend für Erbe/Storz/Wolf 5 m
Bipolar connecting cable compatible with Erbe/Storz/Wolf 5 m
- 80-332-04 2x Volkmann Wundhaken, stumpf, 4-zinkig, Ringgriff, 23 cm
2x Volkmann retractor, blunt, 4 prongs, ring handle, 23 cm
- 80-330-04 2x Volkmann Wundhaken, scharf, 4-zinkig, Ringgriff, 23 cm
2x Volkmann retractor, sharp, 4 prongs, ring handle, 23 cm
- 80-330-06 2x Volkmann Wundhaken, scharf, 6-zinkig, Ringgriff, 23 cm
2x Volkmann retractor, sharp, 6 prongs, ring handle, 23 cm
- 80-350-01 10x Halsted-Mosquito-Klemme, gerade, anatomisch, 12,5 cm
10x Halsted-Mosquito artery forceps, straight, anatomical, 12.5 cm
- 80-350-02 10x Halsted-Mosquito-Klemme, gebogen, anatomisch, 12,5 cm
10x Halsted-Mosquito artery forceps, curved, anatomical, 12.5 cm
- 80-366-14 10x Pean Arterienklemme, gebogen, anatomisch, fein, 14 cm
10x Pean artery forceps, curved, anatomical, fine, 14 cm

- 80-366-16 6x Pean Arterienklemme, gebogen, anatomisch, fein, 16,5 cm
6x Pean artery forceps, curved, anatomical, fine, 16.5 cm
- 80-374-14 6x Crile Arterienklemme, gebogen, anatomisch, 14,5 cm
6x Crile artery forceps, curved, anatomical, 14.5 cm
- 80-370-14 6x Kocher Arterienklemme, gerade, chirurgisch, fein, 14 cm
6x Kocher artery forceps, straight, 1:2 teeth, fine, 14 cm
- 80-357-12 3x Präparierklemme, leicht gebogen, anatomisch, ohne Sperre, 12,5 cm / 3x Artery Forceps, slightly curved, anatomical, without, ratchet, 12.5 cm
- 80-392-09 12x Backhaus Tuchklemme, gebogen, scharf, 9 cm
12x Backhaus towel clamp, curved, sharp, 9 cm
- 80-400-15 2x Allis Gewebefasszange, gerade, 4:5 Zähne, 15,5 cm
2x Allis tissue holding forceps, straight, 4:5 teeth, 15.5 cm
- 80-403-15 2x Braun Hakenzange, gerade, 4:4 Zähne, scharf, 15,5 cm
2x Braun hook forceps, straight, 4:4 teeth, sharp, 15.5 cm
- 80-440-15 Cooper Schere, gerade, spitz-spitz, 14,5 cm
Cooper scissors, straight, sharp-sharp, 14.5 cm
- 80-448-15 Cooper Schere, gebogen, spitz-stumpf, 14,5 cm
Cooper scissors, curved, sharp-blunt, 14.5 cm
- 80-468-21 Killian Laryngofissur-Schere, gewinkelt, gezahnt, 20 cm
Killian laryngectomy scissors, angled, serrated, 20 cm
- 80-470-16 Kocher Führungs-sonde, mit Öffnung, 12,5 mm, 16,5 cm
Kocher director, with opening, 12.5 mm, 16.5 cm
- 80-471-15 Hohlsonde, gerade, 14,5 cm
Hollow probe, straight, 14.5 cm
- 80-501-03 Metallschale, B4, Ø 85 mm, Höhe 40 mm, 160 ml
Metal bowl, B4, Ø 85 mm, height 40 mm, 160 ml
- 80-504-05 Medizinbecher, graduert, 50 ml
Medical cup, graduated, 50 ml
- 80-528-18 Kornzangen-Behälter, Edelstahl, Ø 50 mm, Höhe 180 mm
Forceps holder, stainless steel, Ø 50 mm, height 180 mm

Ergänzung

Supplement

- 10-360-11 Skalpell-Klingen, Nr. 11, einzeln steril verpackt, 100 Stück
Scalpel blades, no. 11, single sterile packed, 100 pieces
- 10-360-15 Skalpell-Klingen, Nr. 15, einzeln steril verpackt, 100 Stück
Scalpel blades, no. 15, single sterile packed, 100 pieces
- 80-661-14 Norm-Sterilisations-Container Boden geschlossen, 585x274x138 mm
Maße mit Deckel: 585x278x155 mm / Norm sterilization container
bottom closed, 585x274x138 mm, dimensions with fitted
lid: 585x278x155mm
- 80-662-00 Ventildeckel silber, für Container 80-661-14 585x278 mm
Valve lid silver, for container 80-661-xx, 585x278 mm
- 80-671-60 Edelstahl-Siebkorb Geflecht, Fallgriffe 485x255x70 mm
Stainless steel wire basket, sliding handles 485x255x70 mm
- 80-681-06 Aluminium-Kennzeichnungs-Schild lila, 20 Zeichen 56x17 mm
Aluminium tag purple, 20 letters, 56x17 mm

[Supplement for sales in EU \(outside the EU only on request\)](#)



08 Weichteilchirurgie-Set II

Neck dissection set II

Bestehend aus / Consisting of:

- 06-0741 AV 2x Overholt-Geissendoerfer Ligaturklemme, gebogen, 19,5 cm
2x Overholt-Geissendoerfer ligature forceps, curved, 19.5 cm
- 10-352-08 Cottle Raspatorium, gebogen, 8 mm, 20 cm
Cottle raspatory, curved, 8 mm, 20 cm
- 10-360-03 Skalpellgriff, Nr. 3, 12,5 cm / Scalpell handle, no. 3, 12.5 cm
- 10-360-04 Skalpellgriff, Nr. 4, 13,5 cm / Scalpell handle, no. 4, 13.5 cm
- 10-438-17 Fisch Wundsperrer, mit Gelenken, 3:3 Zähne, halbscharf, zerlegbar, 16,5 cm / Fisch retractor, with joints, 3:3 prongs, semi-sharp, dismountable, 16.5 cm
- 10-481-14 2x Pinzette, chirurgisch, anatomisch, gerade, 2 mm, 14,5 cm
2x Dressing forceps, anatomical, straight, 2 mm, 14.5 cm
- 10-484-14 2x Pinzette, chirurgisch, 1:2 Zähne, gerade, 1,7 mm, 14,5 cm
2x Dressing forceps, 1:2 teeth, straight, 1.7 mm, 14.5 cm
- 10-487-16 DeBakey Pinzette, atraumatisch, gerade, 1,5 mm, 15,5 cm
DeBakey dressing forceps, atraumatic, straight, 1.5 mm, 15.5 cm
- 10-496-12 2x Adson Pinzette, Hartmetall, anatomisch, 12,5 cm
2x Adson dressing forceps, tungsten carbide, anatomical, 12.5 cm
- 10-555-13 Halsey Nadelhalter, Hartmetall, fein, 13 cm
Halsey needle holder, tungsten carbide, delicate, 13 cm
- 20-150-75 Killian-Struycken Septumspekulum, 75 mm, 14 cm
Killian-Struycken septum speculum, 75 mm, 14 cm
- 20-252-02 Hartmann Conchotom, Größe 2, rund, 8 mm, 12 cm
Hartmann cutting forceps, size 2, round, 8 mm, 12 cm
- 20-305-18 Freer Doppelelevatorium, scharf/stumpf, 18,5 cm
Freer double ended elevator, sharp/blunt, 18.5 cm
- 20-311-20 Freer-Joseph Doppel-Raspatorium, 20 cm
Freer-Joseph raspatory double-ended, 20 cm
- 20-605-14 2x Joseph Schere, supercut, gebogen, spitz-spitz, 14,5 cm
2x Joseph scissors, supercut, curved, pointed, 14.5 cm
- 20-610-15 Reynolds Schere, stumpf-stumpf, gebogen, verjüngte Spitzen, 16 cm / Reynolds scissors, blunt, curved, tapered tips, 16 cm
- 20-614-18 2x Metzenbaum Schere, gebogen, stumpf-stumpf, fein, 18 cm
2x Metzenbaum scissors, curved, blunt, fine, 18 cm
- 20-615-15 2x Metzenbaum Schere, Hartmetall, gebogen, stumpf-stumpf, fein, 14,5 cm / 2x Metzenbaum scissors, tungsten carbide, curved, blunt, fine, 14.5 cm
- 20-625-11 2x Stevens Gefäßschere, verjüngte Spitzen, supercut, gebogen, 11,5 cm / 2x Stevens vascular scissors, tapered tips, supercut, curved, 11.5 cm
- 20-713-12 2x Adson-Brown Pinzette, Hartmetall, 7:8 Zähne, 12,5 cm
2x Adson-Brown forceps, tungsten carbide, 7:8 teeth, 12.5 cm
- 20-730-16 2x Jansen Nasenpinzette, anatomisch, bajonett, 2,0 mm, 16 cm
2x Jansen nasal forceps, anatomical, bayonet, 2.0 mm, 16 cm
- 20-740-15 Crile-Wood Nadelhalter, Hartmetall, 15 cm
Crile-Wood needle holder, tungsten carbide, 15 cm
- 30-080-10 Frazier Saugrohr, mit Griffplatte und Unterbrecher, 10 CH, 9 cm
Frazier suction tube, with suction control, 10 FR, 9 cm
- 30-080-12 Frazier Saugrohr, mit Griffplatte und Unterbrecher, 12 CH, 9 cm
Frazier suction tube, with suction control, 12 FR, 9 cm
- 30-080-15 Frazier Saugrohr, mit Griffplatte und Unterbrecher, 15 CH, 9 cm
Frazier suction tube, with suction control, 15 FR, 9 cm
- 40-365-01 Hurd Unterbindungsnadel, rechts, 22 cm
Hurd tonsil suture needle, right, 22 cm
- 40-390-21 Blohmke Fasszange, gebogen, 20 cm
Blohmke tonsil forceps, curved, 20 cm
- 40-402-20 2x Tonsillen-Pinzette, 1:2 Zähne, fein, 2 mm, 20 cm
2x Tonsil dissecting forceps, 1:2 teeth, fine, 2 mm, 20 cm
- 40-405-20 2x Tonsillen-Pinzette, 1:2 Zähne, fein, 2 mm, 20,5 cm
2x Tonsil dissecting forceps, 1:2 teeth, fine, 2 mm, 20.5 cm
- 40-420-29 Yankauer Saugrohr, für Erwachsene, 6 mm, abschraubbarer Ansatz, Öffnung 3 mm, 28,5 cm / Yankauer Suction tube, for adults, 6 mm, detachable tip, opening 3 mm, 28.5 cm
- 40-450-19 2x Schnid Tonsillenklemme, einseitig offener Ring, schlank, leicht gebogen, 19 cm / 2x Schnid tonsil forceps, one ring open, slender, slightly curved, 19 cm
- 40-457-19 2x Negus Tonsillenklemme, schlank, stark gebogen, 20 cm
2x Negus tonsil forceps, slender, wide curve, 20 cm
- 40-465-18 Crile-Wood Nadelhalter, schlank, Hartmetall, 18 cm
Crile-Wood needle holder, slender, tungsten carbide, 18 cm
- 40-474-20 Gross Kornzange, gebogen, 20 cm
Gross sponge forceps, curved, 20 cm
- 80-053-01 Monopolare Messerelektrode, seitliche Spitze m. Schaft 4 mm, schwarz, 5 Stück/Box / Monopolar knife electrode, cutting edge sideways w. 4mm shaft, black, 5 pieces/box
- 80-112-19 Bipolare Pinzette, NON-STICK, bajonett, Spitze 8 mm lang, 2,0 mm breit, Führungsstift, 19,5 cm
Bipolar forceps, NON-STICK, bayonet, tip length 8 mm, 2.0 mm wide, guide pin, 19.5 cm
- 80-309-51 2x Langenbeck Wundhaken, Ringgriff, 51x11 mm, 21 cm
2x Langenbeck retractor, ring handle, 51x11 mm, 21 cm
- 80-312-21 Schönborn Schilddrüsenhaken, 6,5 x 13 mm, 20,5 cm
Schönborn retractor, 6.5 x 13 mm, 20.5 cm
- 80-317-00 2x Baby-Roux Haken, doppelendig, 16x16 und 21x19 mm, 13,5 cm
2x Baby-Roux retractor, double ended, 16x16 and 21x19 mm, 13.5 cm
- 80-318-50 Bipolares Anschlusskabel passend für Erbe/Storz/Wolf 5 m
Bipolar connecting cable compatible with Erbe/Storz/Wolf 5 m
- 80-330-02 2x Volkmann Wundhaken, scharf, 2-zinkig, Ringgriff, 23 cm
2x Volkmann retractor, sharp, 2 prongs, ring handle, 23 cm
- 80-330-03 2x Volkmann Wundhaken, scharf, 3-zinkig, Ringgriff, 23 cm
2x Volkmann retractor, sharp, 3 prongs, ring handle, 23 cm
- 80-330-04 2x Volkmann Wundhaken, scharf, 4-zinkig, Ringgriff, 23 cm
2x Volkmann retractor, sharp, 4 prongs, ring handle, 23 cm
- 80-330-06 2x Volkmann Wundhaken, scharf, 6-zinkig, Ringgriff, 23 cm
2x Volkmann retractor, sharp, 6 prongs, ring handle, 23 cm
- 80-340-01 Trachealhäkchen, scharf, 1-zinkig, glatter Griff, 17 cm
Trachea hook, sharp, 1 prong, flat handle, 17 cm
- 80-340-02 Trachealhäkchen, scharf, 2-zinkig, glatter Griff, 17 cm
Trachea hook, sharp, 2 prong, flat handle, 17 cm
- 80-350-01 10x Halsted-Mosquito-Klemme, gerade, anatomisch, 12,5 cm
10x Halsted-Mosquito artery forceps, straight, anatomical, 12.5 cm
- 80-350-02 10x Halsted-Mosquito-Klemme, gebogen, anatomisch, 12,5 cm
10x Halsted-Mosquito artery forceps, curved, anatomical, 12.5 cm
- 80-360-14 2x Präparierklemme, leicht gebogen, anatomisch, ohne Sperre, 14,5 cm / 2x Artery Forceps, slightly curved, anatomical, without ratchet, 14.5 cm
- 80-365-14 10x Pean Arterienklemme, gerade, anatomisch, fein, 14 cm
10x Pean artery forceps, straight, anatomical, fine, 14 cm
- 80-366-16 2x Pean Arterienklemme, gebogen, anatomisch, fein, 16,5 cm
2x Pean artery forceps, curved, anatomical, fine, 16.5 cm
- 80-370-14 4x Kocher Arterienklemme, gerade, chirurgisch, fein, 14 cm
4x Kocher artery forceps, straight, 1:2 teeth, fine, 14 cm
- 80-392-11 10x Backhaus Tuchklemme, gebogen, scharf, 11 cm
10x Backhaus towel clamp, curved, sharp, 11 cm
- 80-401-14 2x Baby-Allis Gewebefasszange, gerade, 4:5 Zähne, 14,5 cm
2x Baby-Allis tissue holding forceps, straight, 4:5 teeth, 14.5 cm
- 80-403-15 2x Braun Hakenzange, gerade, 4:4 Zähne, scharf, 15,5 cm
2x Braun hook forceps, straight, 4:4 teeth, sharp, 15.5 cm
- 80-406-01 Elektroden-Handgriff, mit 2 Schaltern, schneiden & koagulieren, 4 mm Ansatz, für abnehmbare Anschlusskabel
Electrode handle, with 2 switches, cutting and coagulating, 4 mm plug, for removable connecting cable

- 80-408-40 Monopolares Anschlusskabel, für SPIGGLE & THEIS Elektrodenhandgriffe, passend für Erbe ICC/ACC, Wolf/Storz, 4m, geräteseitig / Monopolar connecting cable, for SPIGGLE & THEIS electrode handles, compatible w. Erbe ICC/ACC,Wolf/Storz, 4m, unit-side
- 80-442-15 Cooper Schere, gerade, spitz-stumpf, 14,5 cm
Cooper scissors, straight, sharp-blunt, 14.5 cm
- 80-468-21 Killian Laryngofissur-Schere, gewinkelt, gezahnt, 20 cm
Killian laryngectomy scissors, angled, serrated, 20 cm
- 80-470-16 Kocher Führungssonde, mit Öffnung, 12,5 mm, 16,5 cm
Kocher director, with opening, 12.5 mm, 16.5 cm
- 80-472-35 Redon Führungsnadel, Lanzettspitze, leicht gebogen, 3,5 mm, 18,5 cm / Redon guide needle, lancet tip, slight curve, 3.5 mm, 18.5 cm
- 80-472-40 Redon Führungsnadel, Lanzettspitze, leicht gebogen, 4 mm, 18,5 cm / Redon guide needle, lancet tip, slight curve, 4 mm, 18.5 cm
- 80-501-02 Metallschale, B2, Ø 60 mm, Höhe 29 mm, 60 ml
Metal bowl, B2, Ø 60 mm, height 29 mm, 60 ml
- 80-501-03 Metallschale, B4, Ø 85 mm, Höhe 40 mm, 160 ml
Metal bowl, B4, Ø 85 mm, height 40 mm, 160 ml
- 80-501-04 Metallschale, B6, Ø 110 mm, Höhe 55 mm, 400 ml
Metal bowl, B6, Ø 110 mm, height 55 mm, 400 ml
- 80-525-25 Nierenschale, Edelstahl, 250 mm
Kidney bowl, stainless steel, 250 mm

Ergänzung

Supplement

- 80-661-14 Norm-Sterilisations-Container Boden geschlossen, 585x274x138 mm
Maße mit Deckel: 585x278x155 mm / Norm sterilization container bottom closed, 585x274x138 mm, dimensions with fitted lid: 585x278x155mm
- 80-662-00 Ventildeckel silber, für Container 80-661-14 585x278 mm
Valve lid silver, for container 80-661-xx, 585x278 mm
- 80-671-60 Edelstahl-Siebkorb Geflecht, Fallgriffe 485x255x70 mm
Stainless steel wire basket, sliding handles 485x255x70 mm
- 80-681-05 Aluminium-Kennzeichnungs-Schild gelb, 20 Zeichen 56x17 mm
Aluminium tag yellow, 20 letters, 56x17 mm

Supplement for sales in EU (outside the EU only on request)

09 Mikro-Gefäß-Instrumentarium-Set

Micro vascular set

Bestehend aus / Consisting of:

- 10-487-16 DeBakey Pinzette, atraumatisch, gerade, 1,5 mm, 15,5 cm
DeBakey dressing forceps, atraumatic, straight, 1.5 mm, 15.5 cm
- 10-490-16 DeBakey Pinzette, atraumatisch, gewinkelt, 2 mm, 15,5 cm
DeBakey dressing forceps, atraumatic, angled, 2mm, 15.5 cm
- 10-498-15 Wullstein Pinzette, anatomisch, gerade, 1,0 mm, 15,5 cm
Wullstein dressing forceps, anatomical, straight, 1.0 mm, 15.5 cm
- 10-499-15 Wullstein Pinzette, chirurgisch, 1:2 Zähne, gerade, 1,0 mm, 15,5 cm
Wullstein dressing forceps, 1:2 teeth, straight, 1.0 mm, 15.5 cm
- 10-534-12 Schere, supercut, gebogen, spitz-spitz, 11,5 cm
Scissors, supercut, curved, pointed, 11.5 cm
- 20-611-15 Reynolds Schere, supercut, gebogen, stumpf-stumpf, 16 cm
Reynolds scissors, supercut, curved, blunt, 16 cm
- 20-695-11 Mikro-Gefäßschere, gerade, spitz-spitz, 11 cm
Micro vascular scissors, straight, pointed, 11 cm
- 20-696-11 Mikro-Gefäßschere, gebogen, spitz-spitz, 11 cm
Micro vascular scissors, curved, pointed, 11 cm
- 20-697-11 Mikro-Gefäßschere, gewinkelt, spitz-spitz, 10 cm
Micro vascular scissors, angled, pointed, 10 cm
- 20-760-14 Castroviejo Mikro-Gefäß-Nadelhalter, mit Sperre, gerade, 14,5 cm / Castroviejo micro vascular needle holder, with ratchet, straight, 14.5 cm
- 20-761-14 Castroviejo Mikro-Gefäß-Nadelhalter, mit Sperre, gebogen, 14,5 cm / Castroviejo micro vascular needle holder, with ratchet, curved, 14.5 cm
- 80-123-16 Bipolare Pinzette, NON-STICK, kniegebogen, extra fein, Spitze 8mm lang, 0,2 mm breit, Führungsstift, 16,5 cm
Bipolar forceps, NON-STICK, angled, extra fine, tip length 8 mm, 0.2 mm wide, guide pin, 16.5 cm
- 80-318-50 Bipolares Anschlusskabel passend für Erbe/Storz/Wolf 5 m
Bipolar connecting cable compatible with Erbe/Storz/Wolf 5 m
- 80-631-14 Norm-Sterilisations-Container Boden geschlossen, 297x274x138 mm Maße mit Deckel: 585x278x155 mm
Norm sterilization container, bottom closed, 297x274x138 mm, dimensions with fitted lid: 299x278x155mm
- 80-632-00 Ventildeckel silber, für Container 80-631-14, 299x278 mm
Valve lid, silver, for container 80-631-xx, 299x278 mm
- 80-671-20 Edelstahl-Siebkorb, Geflecht, Fallgriffe, 255 x 245 x 50 mm
Stainless steel wire basket, sliding handles, 255 x 245 x 50 mm
- 80-681-02 Aluminium-Kennzeichnungs-Schild, grün, 20 Zeichen, 56 x 17 mm
Aluminium tag, green, 20 letter, 56 x 17 mm

Ergänzung

Supplement

Supplement for sales in EU (outside the EU only on request)



08 Tränenweg-Chirurgie-Set

Lacrimal duct surgery set

Bestehend aus / Consisting of:

- 10-300-30 Saugrohr, kniegebogen, zylindrisch, 3 mm, 11 cm
Suction tube, angled, cylindrical, 3 mm, 11 cm
- 10-300-40 Saugrohr, kniegebogen, zylindrisch, 4 mm, 11 cm
Suction tube, angled, cylindrical, 4 mm, 11 cm
- 10-481-14 Pinzette, chirurgisch, anatomisch, gerade, 2 mm, 14,5 cm
Dressing forceps, anatomical, straight, 2 mm, 14.5 cm
- 10-484-14 Pinzette, chirurgisch, 1:2 Zähne, gerade, 1,7 mm, 14,5 cm
Dressing forceps, 1:2 teeth, straight, 1.7 mm, 14.5 cm
- 20-100-01 Hartmann Nasenspekulum, für Erwachsene, zerlegbar
Hartmann nasal speculum, for adults, dismountable
- 20-150-55 Killian-Struycken Septumspekulum, 55 mm, 14 cm
Killian-Struycken septum speculum, 55 mm, 14 cm
- 20-150-90 Killian-Struycken Septumspekulum, 90 mm, 14 cm
Killian-Struycken septum speculum, 90 mm, 14 cm
- 20-151-75 Cottle Septumspekulum, mit Stellschraube, 75 mm, 13 cm
Cottle septum speculum, with screw, 75 mm, 13 cm
- 20-215-02 Blakesley Nasenzange, gerade, Griff vergoldet, 4 mm, 11,5 cm
Blakesley nasal forceps, straight, gold plated grip, 4 mm, 11.5 cm
- 20-225-02 Blakesley Nasenzange, 45° aufgebogen, Griff vergoldet, 4 mm, 11,5 cm / Blakesley nasal forceps, 45° curved upwards, gold plated grip, 4 mm, 11.5 cm
- 20-307-18 Weber Doppellevatorium, scharf/stumpf, 18,5 cm
Weber elevator, double ended, sharp/blunt, 18.5 cm
- 20-680-16 Heymann Nasenschere, gezahnt, gerade, fein, 16 cm
Heymann nasal scissors, serrated, straight, fine, 16 cm
- 20-690-01 Conchotomie Schere, gezahnt, gerade, Spülkanal, 13 cm
Nasal concha scissors, serrated, straight, irrigation channel, 13 cm
- 20-730-16 Jansen Nasenpinzette / Jansen nasal forceps
- 20-740-15 Crile-Wood Nadelhalter, Hartmetall, 15 cm
Crile-Wood needle holder, tungsten carbide, 15 cm
- 30-101-25 Eicken Spülröhrchen, lange Biegung, Ø 2,5 mm
Eicken antrum cannula, long curve, Ø 2.5 mm
- 30-101-30 Eicken Spülröhrchen, lange Biegung, Ø 3 mm
Eicken antrum cannula, long curve, Ø 3 mm
- 30-102-25 Eicken Spülröhrchen, kurze Biegung, Ø 2,5 mm
Eicken antrum cannula, short curve, Ø 2.5 mm
- 30-102-30 Eicken Spülröhrchen, kurze Biegung, Ø 3 mm
Eicken antrum cannula, short curve, Ø 3 mm
- 30-200-01 Sichelmesser, spitz, 19,5 cm / Sickle knife, pointed, 19.5 cm
- 30-304-25 Antrumstanze, rückwärts schneidend, drehbar, Spülkanal, 2,5 mm, 10 cm / Antrum punch, backw. cutting, rotatable, irrig. chan., 2.5 mm, 10 cm
- 30-320-01 Durchschneidende Nasenzange, gerade, 5,0x1,5 mm, 14 cm
Throughcutting nasal forceps, straight, 5.0x1.5 mm, 14 cm
- 30-469-20 Kerrison Keilbeinstanze, 40° aufw., Schuh vergold., kpl. zerlegb., 2 mm, 18 cm / Kerrison sphenoid punch, 40° upw., golden tip, totally detachable, 2 mm, 18 cm
- 30-720-16 Draf Siebbeinzängchen, gerade, 7x2,4 mm, 16 cm
Draf ethmoid forceps, straight, 7x2.4 mm, 16 cm
- 30-722-16 Draf Siebbeinzängchen, 60° aufgebogen, 6,5x2,4 mm, 16 cm
Draf ethmoid forceps, 60° angled, 6.5x2.4 mm, 16 cm
- 40-600-12 Speichelgangschere, gewinkelt, mit Knopf, 11,5 cm
Salivary duct scissors, angled, with ball end, 11.5 cm
- 40-606-06 Bangerter Tränenwegkanüle, stumpf, seitliche Öffnung, gerade, Luer-Lock, 0,6x60 mm / Bangerter lacrimal duct cannula, blunt, lateral opening, straight, Luer-lock, 0.6x60 mm
- 40-606-08 Bangerter Tränenwegkanüle, stumpf, seitliche Öffnung, gerade, Luer-Lock, 0,8x60 mm / Bangerter lacrimal duct cannula, blunt, lateral opening, straight, Luer-lock, 0.8x60 mm
- 40-610-12 Bowman Speichelgangsonde, Neusilber, Gr. 1/2, 1,0 u. 1,2 mm, gerade, zylindrisch, 13 cm / Bowman salivary duct probe, alpaca, size 1/2, 1.0 a. 1.2 mm, straight, cylindrical, 13 cm
- 40-609-40 Bowman Speichelgangsonde, Silber, Gr. 0000/000, 0,4 u. 0,6 mm, 12,5 cm / Bowman salivary duct probe, silver, size 0000/000, 0.4 and 0.6 mm, 12.5 cm
- 40-609-34 Bowman Speichelgangsonde, Silber, Gr. 3/4, 1,3 u. 1,4 mm, 12,5 cm / Bowman salivary duct probe, silver, size 3/4, 1.3 a. 1.4 mm, 12.5 cm
- 40-615-01 Wilder Dilator, Gr. 1 (Länge der Spitze 23 mm), Griff-Ø 3 mm, Gesamtlänge 11 cm / Wilder dilator, size 1, (tip length 23 mm), handle Ø 3 mm, total length 11 cm
- 40-615-02 Wilder Dilator, Gr. 2 (Länge der Spitze 18 mm), Griff-Ø 3 mm, Gesamtlänge 11 cm / Wilder dilator, size 2, (tip length 18 mm), handle Ø 3 mm, total length 11 cm
- 40-615-03 Wilder Dilator, Gr. 3 (Länge der Spitze 12 mm), Griff-Ø 3 mm, Gesamtlänge 11 cm / Wilder dilator, size 3, (tip length 12 mm), handle Ø 3 mm, total length 11 cm
- 40-617-00 Speichelgang-Sonden-Set, doppelseitig, biegsam, Nitinol, 6 Größen / Salivary duct probe set, double ended, bendable, nitinol, 6 sizes
- 80-106-19 Bipolare Pinzette, NON-STICK, gerade, Spitze gewinkelt, Spitze 8mm lang, 1 mm breit, Führungsstift, 19,5 cm
Bipolar forceps, NON-STICK, straight, angled tip, tip length 8 mm, 1 mm wide, guide pin, 19.5 cm
- 80-318-50 Bipolares Anschlusskabel passend für Erbe/Storz/Wolf 5 m
Bipolar connecting cable compatible with Erbe/Storz/Wolf 5 m
- 80-392-09 6x Backhaus Tuchklemme, gebogen, scharf, 9 cm
6x Backhaus towel clamp, curved, sharp, 9 cm
- 80-501-03 Metallschale, B4, Ø 85 mm, Höhe 40 mm, 160 ml
Metal bowl, B4, Ø 85 mm, height 40 mm, 160 ml
- 80-504-05 Medizinbecher, graduert, 50 ml / Medical cup, graduated, 50 ml

Ergänzung

Supplement

- 80-631-14 Norm-Sterilisations-Container Boden geschlossen, 297x274x138 mm Maße mit Deckel: 585x278x155 mm
Norm sterilization container, bottom closed, 297x274x138 mm, dimensions with fitted lid: 299x278x155mm
- 80-632-00 Ventildeckel silber, für Container 80-631-14, 299x278 mm
Valve lid, silver, for container 80-631-xx, 299x278 mm
- 80-671-20 Edelstahl-Siebkorb, Geflecht, Fallgriffe, 255 x 245 x 50 mm
Stainless steel wire basket, sliding handles, 255 x 245 x 50 mm
- 80-681-01 Aluminium-Kennzeichnungs-Schild, schwarz, 20 Zeichen, 56 x 17 mm
Aluminium tag, black, 20 letter, 56 x 17 mm

Supplement for sales in EU (outside the EU only on request)

Alphabetisches Inhaltsverzeichnis

Abraham Tonsillmesser	29	Hofer Gaumenbogenhaken	12	Roeder Ligatur-Instrument	19
Allis Gewebe-Fasszange	56	Hohlsonde.....	59	Roux Wundhaken	51
Ansatzrohr.....	35	Huber Universal Handgriff	35	Ruedemann Dilatator für Kleinkinder.....	37
Antibeschlagentmittel	8	Hurd Elevatorium/Retraktor.....	21	Russel-Davis Zungenspatel	15
Baby-Adson Präparierklemme	54	Hurd Unterbindungsnadel.....	20	Saugrohr	24
Baby-Allis Gewebe-Fasszange.....	56	Hurd Raspatorium/Retraktor	21	Seemann-Seiffert Mundsperrerr	18
Baby-Roux Haken.....	51	Indikator-Klebe-Etikett	63	Seiffert Hechtmaulansatz	35
Backhaus Tuchklemme.....	55	Injektionskanüle	33	Schmeden Conchotom	12
Ballenger Fasszange	22	Jatho Nasenrachenzange	11	Schmidt Tonsillenklemme	27
Bangerter Tränenwegkanüle.....	36	Jennings Mundsperrerr	17	Schönborn Schilddrüsenhaken	50
Beckmann Ringmesser	10	Jurasz Nasenrachenzange.....	11	Senn-Miller Wundhaken	50
Bipolare Pinzette, NON-STICK.....	43 - 47	Kabel für Neutral-Elektrode.....	39	Siebkorb	7, 48, 63
Bipolare Präparierschere.....	42	Kabierske Pulverbläser	12	Silikonhalterung	48
Bipolare Saugpinzette	47	Kehlkopf-Kanüle.....	33	Silikon Neutral-Elektrode	38
Bipolares Anschlusskabel.....	41	Kehlkopfspiegel.....	32 - 33	Silikonschützer für Mundsperrerr.....	13
Birkett Tonsillenklemme.....	27	Kehlkopfwatteträger, fein	34	Silikonformschlauch für Mundsperrerr.....	13
Blohmkke Fasszange	22	Kehlkopfszange	34 - 35	Skalpelli-Griff	30
Boettcher Tonsillenschere	25	Kilian Laryngofissur-Schere	59	Skalpelli-Klingen	30
Bowman Speichelgangsonde	36	Klemme.....	28	Sluder-Ballenger Tonsillotom	18
Bozemann Nadelhalter.....	29	Knopfkanüle	36	Speichelgang-Schere	36
Braun Hakenzange.....	56	Knotenführer.....	20	Speichelgang-Sonden-Set	37
Brünings Löffelansatz	35	Kocher Arterienklemme	53	Sternberg Lippenhaken.....	49
Brünings Tonsillmesser	29	Kocher Führungssonde.....	59	Stubbs Ringmesser.....	10
Brünings Tonsillenschnürer	19	Kocher-Langenbeck Wundhaken.....	49	Tablettenschale	61
Brünings Zungenspatel.....	31	Kornzangen-Behälter	62	Tapia Adenoid Spatel.....	31
Buchwald Zungenspatel.....	31	Kugelelektrode	42	Toennis-Adson Tonsillenschere.....	25 - 26
Kennzeichnungs-Schild.....	63	Laborde Trachealdilatator.....	60	Tonsillektomie/Adenotomie-Set	64
Collin Zungenzange	57	Langenbeck Wundhaken.....	50	Tonsillen-Pinzette.....	23
Colver Fasszange	22	Laryngoskop	7, 9	Tonsillen-Schlingen.....	19
Colver-Fischer Tonsillmesser	29	LED-Leuchtgriff.....	8	Tonsillenverbandzange	23
Container-Siegel.....	63	Leiste für Silikonhalterungen	48	Trachealhäkchen	51
Cooper Schere.....	57	Lister Verbandschere	58	Tracheotomie-Set.....	66
Crile Arterienklemme.....	53	Lösungsschale.....	61	Tracheotomie-Set II.....	67
Crile-Wood Nadelhalter	28	Mayo-Hegar Nadelhalter.....	29	Tränenweg-Chirurgie-Set.....	72
Crile-Wood Ryder Nadelhalter	29	Mayo-Stille Schere.....	58	Tuchklemme	55 - 56
Davis-Boyle Mundsperrerr	13	Mclvor Mundsperrerr	13	Ultra-Stop Antibeschlagentmittel.....	6
Davis-Boyle Zungenspatel.....	14	Mclvor Zungenspatel.....	14	Drahtbeige- und Schneideschere.....	19
Davis-Meyer Mundsperrerr	13	Medikamenten-Schälchen.....	62	Ventildeckel für Norm-Sterilisations-Container	63
Dean Tonsillenschere.....	25	Medizinbecher	61	Vogel Ringmesser.....	10
DeBaKey Pinzette	24	Metallschale	61	Volkman Wundhaken.....	50
DeBaKey Nadelhalter.....	29	Metzenbaum Schere.....	26 - 27	Weerda Tracheal-Spekulum	60
Dingmann Mundsperrerr	16	Meuser bipolare Pinzette	46	Weichteilchirurgie-Basis-Set.....	68 - 69
Dingmann Wangenhaltern.....	16	Middeldorf Wundhaken	49	Weichteilchirurgie-Set II	70 - 71
Dingmann Zahnhaken.....	16	Mikro-Gefäß-Instrumentarium.....	71	White Fasszange	22
Draffin Mundsperrerr-Aufhängung.....	17	Mikulicz Tonsillenklemme	28	Wilder Dilatator.....	37
Duval Gewebefasszange	57	Moritz-Schmidt Zungenspatel	31	Yankauer Saugrohr	24
Edna-Lorna Tuchklemme.....	55	Monopolare Elektroden	42	Zungenspatel, Würzburger Modell	15
Elektroden-Handgriff.....	39	Monopolares Anschlusskabel.....	39		
Endoskope	5	Muck Tonsillenschere	25		
Endoskopie-Siebkorb.....	7	Nadelelektrode.....	42		
Eves Tonsillenschnürer.....	19	Nager Gaumensegelhaken	12		
Fadenhäkchen.....	20	Nager Unterbindungsnadel.....	20		
Fasszange	22	Nasopharynx-Set	65		
Flexible Alligator-Fasszange.....	6	Narkosebügel.....	17		
Flexible Biopsiezange	6	Negus Bruststütze	17		
Flexible Reinigungsbürste	6	Negus Ringmesser	10		
Flexibles Endoskop.....	5	Negus Tonsillenklemme.....	27		
Fraenkel Löffelansatz.....	35	Nierenschale.....	62		
Gelenkkloben	17	Norm-Sterilisations-Container.....	63		
Good Tonsillenschere	24	Ochsner-Kocher Arterienklemme.....	55		
Good-Schweckendiek Tonsillenschere.....	24	Overholt-Geissdoerfer Tonsillenklemme.....	27		
Griff für Kehlkopfspiegel.....	33	Pean Arterienklemme	53		
Gross Kornzange.....	28	Pelteson Kehlkopfwatteträger.....	34		
Gross-Maier Kornzange	28	Petrirschale mit Deckel.....	61		
Halsted-Mosquito-Klemme.....	52	Porzellan-Schälchen.....	62		
Halteband für Neutral-Elektrode.....	38	Präparierklemme ohne Sperre.....	53		
Hartmann Conchotom	11	Raspatorium Würzburger Modell.....	21		
Hartmann Zungenspatel	31	Redon Führungsnael.....	59		
Henke Raspatorium.....	20	Reichert Epiglottis Halter	34		
Henke Raspatorium/Dissektor.....	21	Ring Zungenspatel	16		
HF-Generator.....	38	Rochester-Pean Arterienklemme	54		

Abraham tonsil knife.....	29	Halsted-Mosquito artery forceps	52	Rochester-Pean artery forceps	54
Adhesive indicator label.....	63	Handle for laryngeal mirrors.....	33	Roeder ligature instrument	19
Anesthesia frame L-form.....	17	Hartmann cutting forceps	11	Roux retractor	51
Allis tissue holding forceps.....	56	Hartmann tongue depressor	31	Ruedemann dilator for infants	37
Anti-fog.....	8	Henke raspatory.....	20	Russel-Davis tongue depressor	15
Artery forceps.....	28	Henke raspatory/dissector	21	Salivary duct probe set	37
Artery forceps without ratchet.....	53	HF-generator	38	Salivary duct scissors	36
Baby-Adson artery forceps.....	54	Hofer palate retractor.....	12	Scalpel blades.....	30
Baby-Allis tissue holding forceps.....	56	Holding band for neutral electrode.....	38	Scalpel handles.....	30
Baby-Roux retractor.....	51	Hollow probe.....	59	Schmeden cutting forceps.....	12
Backhaus towel clamp.....	55	Huber universal handle	35	Schmidt tonsil forceps.....	27
Ball electrode.....	42	Hurd raspatroy/retractor	21	Schönborn thyroid retractor.....	50
Ballenger tonsil forceps	22	Hurd elevator/retractor.....	21	Seemann-Seiffert mouth gag	18
Bangerter lacrimal duct cannula.....	36	Hurd tonsil suture needle	20	Seiffert alligator tip.....	35
Basket.....	7, 48, 63	Injection needle	33	Senn-Miller retractor	50
Bar for silicone holders.....	48	Jatho epipharyngeal forceps.....	11	Silicone holder.....	48
Beckmann adenoid curette.....	10	Jennings mouth gag.....	17	Silicone insert for mouth gags.....	13
Bipolar connecting cable.....	41	Jurasz adenoid forceps.....	11	Silicone neutral electrode.....	38
Bipolar dissecting scissors.....	42	Kabierske powder blower.....	12	Silicone tubing for mouth gag.....	13
Bipolar forceps, NON-STICK	43 - 47	Kidney bowl.....	62	Sluder-Ballenger tonsillotome.....	18
Bipolar suction forceps.....	47	Kilian laryngectomy scissors	59	Solution bowl.....	63
Birkett tonsil forceps.....	27	Knot tier.....	20	Sternberg lip retractor.....	49
Blohmke tonsil forceps	22	Kocher artery forceps	53	Stubbs adenoid curette	10
Boettcher tonsil scissors	25	Kocher director.....	59	Suction tube	24
Bowman salivary duct probe	36	Kocher-Langenbeck retractor.....	49	Suture hook	20
Bozemann needle holder	29	Laborde tracheal dilatator	60	Tablet dish	61
Braun hook forceps	56	Lacrimal duct surgery set.....	72	Tapia adenoid spatula.....	31
Brünings tip	35	Langenbeck retractor.....	50	Toennis-Adson tonsil scissors.....	25 - 26
Brünings tongue depressor.....	31	Laryngeal cannula.....	33	Tongue depressor, Würzburger model	15
Brünings tonsil knife.....	29	Laryngeal cotton carrier, fine.....	34	Tonsil dissecting forceps	23
Brünings tonsil snare.....	19	Laryngeal forceps.....	34 - 35	Tonsil dressing forceps	23
Buchwald tongue depressor.....	31	Laryngeal mirror.....	32 - 33	Tonsil forceps.....	22
Cabel for neutral electrode.....	39	Laryngoscope.....	7, 9	Tonsil wire loops	19
Cannula, ball-ended.....	36	LED light handles	8	Tonsillectomy/Adenotomy set.....	64
China bowl.....	62	Lister bandage scissors.....	58	Towel clamp.....	55 - 56
Coding label.....	63	Mayo-Hegar needle holder	29	Trachea hook.....	51
Collin tongue forceps.....	57	Mayo-Stille scissors.....	58	Tracheotomy set.....	66
Colver tonsil forceps	22	Mclvor mouth gag	13	Tracheotomy set II	67
Colver-Fischer tonsil knife.....	29	Mclvor tongue depressor.....	14	Ultra-Stop Anti-Fog solution.....	6
Connecting tube.....	35	Medicine cup.....	61	Wire bending and cutting scissors.....	19
Container seal.....	63	Medication dish.....	62	Valve lid for norm sterilization container.....	63
Cooper scissors	57	Metal Bowl	61	Vogel adenoid curette	10
Crile artery forceps.....	53	Metzenbaum scissors	26 - 27	Volkman retractor.....	50
Crile-Wood needle holder	28	Meuser bipolar forceps	46	Weerda tracheal speculum.....	60
Crile-Wood Ryder needle holder.....	29	Micro vascular set	71	White tonsil forceps	22
Davis-Boyle mouth gag.....	13	Middeldorp antrum retractor.....	49	Wilder dilatator	37
Davis-Boyle tongue depressor.....	14	Mikulicz tonsil forceps	28	Yankauer suction tube.....	24
Davis-Meyer mouth gag	13	Moritz-Schmidt tongue depressor	31		
Dean tonsil scissors	25	Monopolar connecting cable	39		
DeBakey dressing forceps	24	Monopolar electrodes	42		
DeBakey needle holder.....	29	Muck tonsil scissors	25		
Dingmann cheek retractors.....	16	Nager pillar retractor	12		
Dingmann mouth gag.....	16	Nager tonsil suture needle.....	20		
Dingmann tooth hooks.....	16	Nasopharyngeal set	65		
Draffin bipod suspension for mouth gags	17	Neck dissection basic set	68 - 69		
Duval tissue forceps.....	57	Neck dissection set II.....	70 - 71		
Edna-Lorna towel clamp	55	Needle electrode.....	42		
Electrode handle.....	39	Negus adenoid curette	10		
Endoscope.....	5	Negus chest support.....	17		
Endoscopy container	7	Negus tonsil forceps	27		
Eves tonsil snare	19	Norm sterilization container	63		
Forceps holder.....	62	Ochsner-Kocher artery forceps.....	55		
Flexible alligator forceps	6	Overholt-Geissdoerfer tonsil forceps	27		
Flexible biopsy forceps.....	6	Pean artery forceps	53		
Flexible cleaning brush.....	6	Pelteson laryngeal cotton carrier.....	34		
Flexible endoscope.....	5	Petri Bowl.....	61		
Fraenkel tip.....	35	Raspatory Würzburg type	21		
Good tonsil scissors.....	24	Redon guide needle	59		
Good-Schweckendiek tonsil scissors.....	24	Reichert epiglottis holder	34		
Gross sponge forceps.....	28	Ring tongue depressor	16		
Gross-Maier sponge forceps.....	28	Rotation clamp	17		



Numerisches Inhaltsverzeichnis

Numeric Content

10-155-00.....	12	40-206-01.....	10	40-340-11.....	17	40-462-18.....	28	40-581-00.....	35	80-113-23.....	45
10-155-01.....	12	40-206-02.....	10	40-340-13.....	17	40-465-18.....	28	40-600-12.....	36	80-114-19.....	45
10-155-02.....	12	40-206-03.....	10	40-340-15.....	17	40-465-20.....	28	40-601-12.....	36	80-115-19.....	45
10-303-18.....	24	40-211-07.....	10	40-341-11.....	18	40-465-23.....	28	40-604-08.....	36	80-116-19.....	45
10-360-03.....	30	40-220-01.....	11	40-341-13.....	18	40-474-20.....	28	40-604-10.....	36	80-117-19.....	46
10-360-04.....	30	40-220-02.....	11	40-342-09.....	18	40-475-26.....	28	40-604-12.....	36	80-118-19.....	46
10-360-07.....	30	40-225-00.....	11	40-342-11.....	18	40-480-22.....	29	40-606-06.....	36	80-119-19.....	46
10-360-10.....	30	40-230-21.....	12	40-342-13.....	18	40-481-18.....	29	40-606-08.....	36	80-120-19.....	46
10-360-11.....	30	40-232-23.....	12	40-350-01.....	18	40-482-23.....	29	40-607-06.....	36	80-121-18.....	46
10-360-15.....	30	40-300-01.....	13	40-350-02.....	18	40-484-22.....	29	40-609-00.....	36	80-122-18.....	47
10-360-33.....	30	40-300-02.....	13	40-350-03.....	18	40-490-16.....	29	40-609-01.....	36	80-123-16.....	46
10-745-12.....	19	40-302-01.....	13	40-350-10.....	18	40-490-18.....	29	40-609-12.....	36	80-125-03.....	47
20-252-01.....	11	40-302-02.....	13	40-355-28.....	19	40-491-20.....	29	40-609-23.....	36	80-125-07.....	47
20-252-02.....	11	40-302-03.....	13	40-357-28.....	19	40-500-19.....	31	40-609-34.....	36	80-125-12.....	47
20-252-03.....	11	40-302-04.....	13	40-359-27.....	19	40-504-15.....	31	40-609-40.....	36	80-125-20.....	47
20-252-04.....	11	40-303-00.....	13	40-360-40.....	19	40-506-19.....	31	40-609-45.....	36	80-127-03.....	46
20-254-00.....	12	40-305-01.....	13	40-360-50.....	19	40-508-18.....	31	40-609-56.....	36	80-127-07.....	46
20-254-01.....	12	40-305-99.....	13	40-361-45.....	19	40-509-17.....	31	40-609-67.....	36	80-127-12.....	46
20-254-02.....	12	40-310-01.....	14	40-365-01.....	20	40-510-01.....	31	40-609-78.....	36	80-127-20.....	46
20-254-03.....	12	40-310-02.....	14	40-365-02.....	20	40-510-02.....	31	40-613-08.....	37	80-128-03.....	47
20-612-18.....	26	40-310-03.....	14	40-367-24.....	20	40-510-03.....	31	40-615-01.....	37	80-128-07.....	47
20-612-20.....	26	40-311-01.....	14	40-368-21.....	20	40-520-00.....	33	40-615-02.....	37	80-128-12.....	47
20-613-18.....	26	40-311-02.....	14	40-369-21.....	20	40-524-00.....	32	40-615-03.....	37	80-128-20.....	47
20-613-20.....	26	40-311-03.....	14	40-370-21.....	20	40-524-01.....	32	40-617-00.....	37	80-129-12.....	46
20-614-18.....	26	40-311-04.....	14	40-381-12.....	21	40-524-02.....	32	40-745-18.....	29	80-150-17.....	44
20-614-20.....	26	40-311-15.....	14	40-381-15.....	21	40-524-03.....	32	70-211-00.....	8	80-150-20.....	44
20-615-18.....	26	40-311-25.....	14	40-382-24.....	20	40-524-04.....	32	70-211-01.....	8	80-150-23.....	44
20-615-20.....	26	40-311-35.....	14	40-384-23.....	21	40-524-05.....	32	70-211-10.....	8	80-150-25.....	44
20-616-18.....	26	40-312-01.....	14	40-386-23.....	21	40-524-06.....	32	70-211-20.....	8	80-152-17.....	44
20-889-18.....	28	40-312-02.....	14	40-388-21.....	21	40-524-07.....	32	70-211-30.....	8	80-152-20.....	44
30-160-01.....	6	40-312-03.....	14	40-390-21.....	22	40-524-08.....	32	70-211-40.....	8	80-152-23.....	44
30-160-02.....	6	40-312-04.....	14	40-392-19.....	22	40-524-09.....	32	70-211-50.....	8	80-156-20.....	44
30-160-03.....	6	40-312-05.....	14	40-394-18.....	22	40-524-10.....	32	80-002-80.....	38	80-156-23.....	44
30-160-05.....	8	40-313-01.....	14	40-394-23.....	22	40-524-20.....	32	80-010-40.....	38	80-158-20.....	44
30-172-40.....	6	40-313-02.....	14	40-395-22.....	22	40-524-30.....	32	80-011-40.....	38	80-158-23.....	44
30-173-40.....	6	40-313-03.....	14	40-400-20.....	23	40-525-00.....	33	80-012-75.....	38	80-180-13.....	42
30-175-40.....	6	40-313-04.....	14	40-401-20.....	23	40-525-01.....	33	80-053-01.....	42	80-181-14.....	42
30-700-01.....	17	40-313-05.....	14	40-402-20.....	23	40-525-02.....	33	80-053-02.....	42	80-182-17.....	42
40-100-70.....	9	40-315-01.....	15	40-405-20.....	23	40-525-03.....	33	80-053-03.....	42	80-183-14.....	47
40-100-90.....	9	40-315-02.....	15	40-406-20.....	23	40-525-04.....	33	80-053-04.....	42	80-183-18.....	42
40-103-70.....	9	40-315-03.....	15	40-407-20.....	23	40-525-05.....	33	80-053-05.....	42	80-183-20.....	47
40-103-90.....	9	40-315-04.....	15	40-408-20.....	23	40-525-06.....	33	80-100-16.....	45	80-250-00.....	48
40-105-70.....	9	40-315-05.....	15	40-410-20.....	24	40-525-07.....	33	80-100-19.....	45	80-260-34.....	48
40-105-90.....	9	40-318-01.....	15	40-412-20.....	24	40-525-08.....	33	80-101-16.....	45	80-270-24.....	48
40-107-70.....	9	40-318-02.....	15	40-420-29.....	24	40-525-09.....	33	80-101-19.....	45	80-272-24.....	48
40-110-00.....	7	40-318-03.....	15	40-420-99.....	24	40-525-10.....	33	80-101-22.....	45	80-275-24.....	48
40-110-30.....	7	40-318-04.....	15	40-421-21.....	24	40-525-20.....	33	80-103-16.....	45	80-280-00.....	48
40-110-70.....	7	40-318-05.....	15	40-430-19.....	24	40-525-30.....	33	80-103-19.....	45	80-302-12.....	49
40-111-70.....	7	40-320-01.....	15	40-431-19.....	24	40-553-01.....	33	80-105-16.....	45	80-302-14.....	49
40-112-00.....	7	40-320-03.....	15	40-433-18.....	25	40-553-02.....	33	80-105-19.....	45	80-302-16.....	49
40-112-30.....	7	40-322-02.....	16	40-434-18.....	25	40-554-13.....	33	80-106-16.....	45	80-306-17.....	49
40-112-70.....	7	40-322-03.....	16	40-436-17.....	25	40-558-24.....	34	80-106-19.....	45	80-306-22.....	49
40-200-00.....	10	40-322-04.....	16	40-438-18.....	25	40-560-22.....	34	80-106-25.....	45	80-306-30.....	49
40-200-01.....	10	40-322-05.....	16	40-440-18.....	25	40-561-28.....	34	80-107-16.....	45	80-308-06.....	49
40-200-02.....	10	40-323-02.....	16	40-441-18.....	26	40-570-01.....	34	80-107-19.....	45	80-308-07.....	49
40-200-03.....	10	40-327-00.....	16	40-442-18.....	26	40-570-02.....	34	80-109-16.....	45	80-308-10.....	49
40-200-04.....	10	40-327-99.....	16	40-450-19.....	27	40-572-01.....	35	80-110-16.....	45	80-308-15.....	49
40-203-00.....	10	40-330-09.....	17	40-451-19.....	27	40-572-02.....	35	80-110-19.....	45	80-308-20.....	49
40-203-01.....	10	40-330-14.....	17	40-454-20.....	27	40-575-00.....	35	80-111-16.....	45	80-309-11.....	50
40-203-02.....	10	40-335-01.....	17	40-455-20.....	27	40-576-20.....	35	80-111-19.....	45	80-309-14.....	50
40-203-03.....	10	40-335-99.....	17	40-457-19.....	27	40-578-00.....	35	80-112-16.....	45	80-309-16.....	50
40-203-04.....	10	40-337-00.....	17	40-458-19.....	27	40-579-00.....	35	80-112-19.....	45	80-309-41.....	50
40-206-00.....	10	40-340-09.....	17	40-460-19.....	27	40-580-00.....	35	80-113-19.....	45	80-309-51.....	50

80-312-21.....	50	80-375-14.....	53	80-472-40.....	59	80-671-60.....	63
80-314-16.....	50	80-376-16.....	54	80-478-14.....	60	80-681-01.....	63
80-315-16.....	50	80-380-18.....	54	80-479-14.....	60	80-681-02.....	63
80-316-50.....	41	80-382-18.....	54	80-482-19.....	60	80-681-03.....	63
80-317-00.....	51	80-382-20.....	54	80-501-01.....	61	80-681-04.....	63
80-317-30.....	41	80-383-18.....	54	80-501-02.....	61	80-681-05.....	63
80-317-50.....	41	80-383-20.....	54	80-501-03.....	61	80-681-06.....	63
80-318-01.....	51	80-383-22.....	54	80-501-04.....	61	80-681-07.....	63
80-318-02.....	51	80-385-18.....	55	80-503-03.....	61	80-683-10.....	63
80-318-03.....	51	80-385-20.....	55	80-504-05.....	61	80-684-10.....	63
80-318-30.....	41	80-387-18.....	55	80-505-10.....	61	80-688-00.....	63
80-318-50.....	41	80-387-20.....	55	80-505-20.....	61	80-691-01.....	7
80-319-30.....	41	80-392-09.....	55	80-506-30.....	61	80-692-01.....	7
80-319-50.....	41	80-392-11.....	55	80-507-40.....	61	130 400 028ST.....	5
80-320-30.....	41	80-392-13.....	55	80-509-75.....	61	130 400 034ST.....	5
80-320-50.....	41	80-394-09.....	55	80-512-00.....	61	130 414 040ST.....	5
80-322-30.....	41	80-394-13.....	55	80-515-06.....	61		
80-322-50.....	41	80-397-12.....	56	80-515-08.....	61		
80-330-01.....	50	80-397-14.....	56	80-515-10.....	61		
80-330-02.....	50	80-400-15.....	56	80-519-00.....	62		
80-330-03.....	50	80-401-14.....	56	80-519-01.....	62		
80-330-04.....	50	80-403-15.....	56	80-519-02.....	62		
80-330-06.....	50	80-405-20.....	57	80-519-03.....	62		
80-332-01.....	50	80-406-01.....	39	80-520-06.....	62		
80-332-02.....	50	80-406-02.....	39	80-520-08.....	62		
80-332-03.....	50	80-407-16.....	57	80-525-17.....	62		
80-332-04.....	50	80-407-40.....	40	80-525-25.....	62		
80-332-06.....	50	80-408-40.....	40	80-528-13.....	62		
80-340-01.....	51	80-409-30.....	40	80-528-18.....	62		
80-340-02.....	51	80-410-04.....	39	80-528-20.....	62		
80-340-03.....	51	80-410-24.....	39	80-530-20.....	62		
80-340-04.....	51	80-411-04.....	39	80-621-05.....	7		
80-342-01.....	51	80-411-24.....	39	80-622-56.....	7		
80-342-02.....	51	80-412-04.....	39	80-623-22.....	7		
80-342-03.....	51	80-412-24.....	39	80-631-10.....	63		
80-342-04.....	51	80-413-00.....	39	80-631-12.....	63		
80-350-01.....	52	80-414-50.....	40	80-631-14.....	63		
80-350-02.....	52	80-415-50.....	40	80-631-21.....	63		
80-350-03.....	52	80-440-13.....	57	80-641-14.....	63		
80-350-04.....	52	80-440-15.....	57	80-661-12.....	63		
80-352-01.....	52	80-442-13.....	57	80-661-14.....	63		
80-352-02.....	52	80-442-15.....	57	80-661-21.....	63		
80-352-03.....	52	80-444-13.....	57	80-632-00.....	63		
80-352-04.....	52	80-444-15.....	57	80-632-01.....	63		
80-353-01.....	52	80-445-15.....	40	80-632-02.....	63		
80-354-01.....	52	80-446-13.....	58	80-632-03.....	63		
80-354-02.....	52	80-446-15.....	58	80-632-04.....	63		
80-354-03.....	52	80-448-13.....	58	80-632-05.....	63		
80-354-04.....	52	80-450-13.....	58	80-642-00.....	63		
80-356-12.....	53	80-450-15.....	58	80-642-01.....	63		
80-357-12.....	53	80-455-15.....	58	80-642-02.....	63		
80-359-14.....	53	80-455-17.....	58	80-642-03.....	63		
80-360-14.....	53	80-457-15.....	58	80-642-04.....	63		
80-361-14.....	53	80-459-15.....	58	80-642-05.....	63		
80-365-14.....	53	80-460-15.....	58	80-662-00.....	63		
80-365-16.....	53	80-465-15.....	58	80-662-01.....	63		
80-366-14.....	53	80-465-18.....	58	80-662-02.....	63		
80-366-16.....	53	80-465-20.....	58	80-662-03.....	63		
80-370-14.....	53	80-468-21.....	59	80-662-04.....	63		
80-370-16.....	53	80-470-16.....	59	80-662-05.....	63		
80-372-14.....	53	80-471-15.....	59	80-671-20.....	63		
80-372-16.....	53	80-472-25.....	59	80-671-25.....	63		
80-374-14.....	53	80-472-35.....	59	80-671-40.....	63		



Umrechnungstabelle - Ch/Fr - mm - inch

Conversion table - Ch/Fr - mm - inch

Charrière (CH) French (F)	mm	Inch
1	0,33	0,013
2	0,67	0,025
3	1,00	0,039
4	1,33	0,051
5	1,67	0,065
6	2,00	0,079
7	2,33	0,092
8	2,67	0,105
9	3,00	0,118
10	3,33	0,131
11	3,67	0,144
12	4,00	0,156
13	4,33	0,170
14	4,67	0,184
15	5,00	0,197
16	5,33	0,210
17	5,67	0,223
18	6,00	0,237
19	6,33	0,249
20	6,67	0,263
21	7,00	0,276
22	7,33	0,288
23	7,67	0,302
24	8,00	0,315
25	8,33	0,328
26	8,67	0,341
27	9,00	0,354
28	9,33	0,367
29	9,67	0,380
31	10,23	0,407
32	10,67	0,420
34	11,33	0,446
36	12,00	0,472
38	12,67	0,494
40	13,33	0,520
45	15,00	0,591



© 2023 by SPIGGLE & THEIS Medizintechnik GmbH

Änderungen und Irrtümer – einschließlich Bilder - vorbehalten.
Produktsortiment kann pro Land abweichen.

Modifications and errors – including pictures – reserved.
Product range might vary per country.



Burghof 14 · 51491 Overath · Germany
Phone: +49 2206 90 81 - 0
Fax: +49 2206 90 81 - 13
info@spiggle-theis.com
www.spiggle-theis.com