

NNH-Instrumentarium

Sinus Instruments

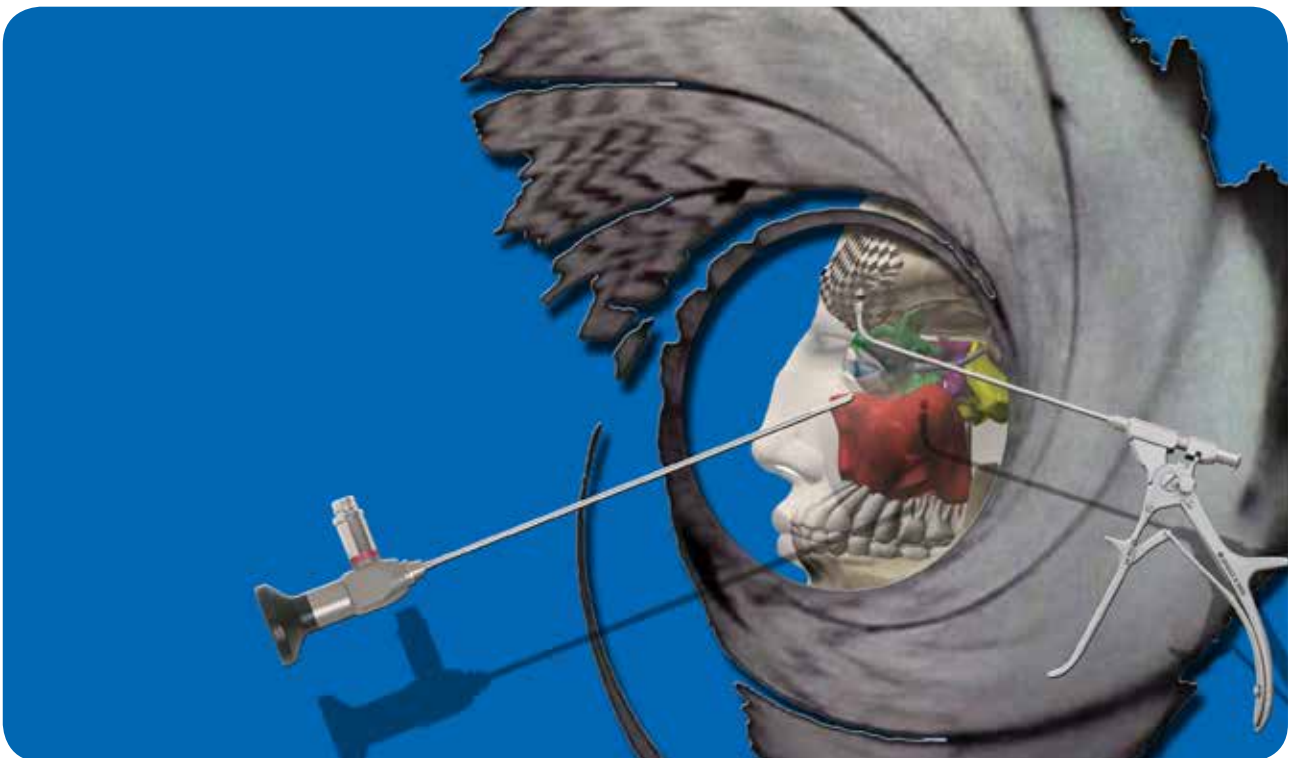



GESCHICHTE

Spiggle & Theis Medizintechnik GmbH wurde 1994 von den Geschäftsführern David Spiggle und Detlef Theis gegründet. Bis heute haben wir uns vom reinen Vertriebsunternehmen zu einem renommierten Hersteller von Medizinprodukten im Bereich der HNO-Chirurgie weiterentwickelt. Zu unseren Kunden in Deutschland zählen mehr als 700 Kliniken und wir exportieren mittlerweile in über 75 Länder weltweit.



HISTORY

Spiggle & Theis Medizintechnik GmbH was founded in 1994 by the managing directors David Spiggle and Detlef Theis. The company evolved from being purely a distributor to the established manufacturer of medical products in the area of ENT that it is today. We can count over 700 clinics amongst our German customers and we export to over 75 countries worldwide.

DAS MASS DER DINGE

Im chirurgischen Instrumentenbau gilt das Siegel "MADE IN GERMANY" auch heute noch als Inbegriff von Qualität. Unsere chirurgischen Instrumente werden in allen Produktionsstufen unter strengsten Qualitätsanforderungen in Deutschland produziert, sind also noch echt "MADE IN GERMANY". Zur Verarbeitung wird ausschließlich Instrumentenstahl bester Güte verwendet, welcher den hohen Anforderungen moderner Chirurgie auch dauerhaft gerecht wird.

THE SEAL OF HIGHEST QUALITY

The stamp "MADE IN GERMANY" is still the epitome of quality standards in the production of surgical instruments in the world today. In Germany, our surgical instruments are subjected to the strictest quality requirements at every step of their production, so they are, in the truest sense of the words, "MADE IN GERMANY". Only the highest standard of instrument steel, capable of consistently meeting the demands of modern surgery, is used in the production.

SICHERHEIT ZUERST

Die Gesundheit der Patienten und somit die Sicherheit und Qualität unserer Produkte stehen immer im Mittelpunkt unseres Handelns. In diesem Sinne ist Spiggle & Theis Medizintechnik GmbH bereits seit 1997 ISO-zertifiziert und unsere Produkte nach der strengen europäischen Richtlinie für Medizinprodukte CE-gekennzeichnet. Alle unsere Produkte unterliegen einem permanenten Prozess der Qualitätskontrolle, von der Auswahl des Rohmaterials über die einzelnen Fertigungsschritte bis zum Versand.



SAFETY FIRST

The health of our patients and therefore the safety and quality of our products always plays a central role in our decisions. Spiggle & Theis Medizintechnik GmbH has been ISO certified and our products are CE-marked in accordance with the strict European guidelines for medical products since 1997. All our products undergo continual quality checks, from the selection of raw materials, to the individual stages of production and finally their dispatch.

SERVICE

Unsere Kollegen blicken zum Teil auf mehr als 30 Jahre Berufserfahrung im Umgang mit chirurgischen Instrumenten zurück. Dadurch besitzen wir mehr als theoretisches Wissen – Verständnis für die Bedürfnisse unserer Kunden. Darüber hinaus pflegen wir noch den engen, individuellen Kontakt mit den Anwendern. Dies hilft uns bei der steten, praxisorientierten Weiterentwicklung unserer Produkte. Somit garantieren wir hohe Kompetenz und individuellen Service bei der Betreuung unserer Kunden.



SERVICE

Our colleagues in instrument development can look back on over 30 individual years of professional practical experience with ENT-surgical instruments. We offer more than theoretical knowledge – we understand our customers' needs. We enjoy close, personal contact to many of the best surgeons here in Germany. This enables us to continually develop innovative products. We guarantee the highest level of competence and individual service in meeting our customers' requirements.



Contents

1 Ambulantes Nasen-Nebenhöhlen-Instrumentarium 5-8
1 Diagnostic Sinus Instruments 5-8
2 Endoskopie und Videodokumentation 9-18
2 Endoscopy and Video Documentation 9-18
3 Septum-Instrumente 19-26
3 Septum-Instruments 19-26
4 FESS-Instrumente 27-36
4 FESS-Instruments 27-36
5 Stirnhöhlen- und Keilbeinhöhlen-Instrumente 37-44
5 Frontal and Sphenoidal Instruments 37-44
6 Mikroskopische/Endoskopische Instrumente für die Pansinus-Chirurgie 45-55
6 Microscopic/Endoscopic Instruments for Pansinus Surgery 45-55
7 Allgemeines 56-60
7 Miscellaneous 56-60
8 Sterilisationssysteme 61-62
8 Sterilization Systems 61-62
9 Sets 63-65
9 Sets 63-65

Index 66-70
Index 66-70





Diagnostic Sinus Instruments

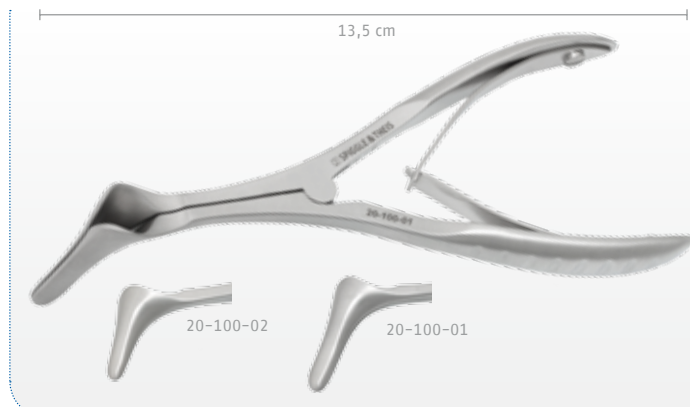

Hartmann Nasenspekulum, 13,5 cm
Hartmann nasal speculum, 13.5 cm

- 20-100-01 Für Erwachsene / for adults
- 20-100-02 Für Jugendliche / for juveniles



Eicken Spülröhrchen, lange Biegung, biegsam, 13,8 cm
Eicken antrum cannula, long curve, bendable, 13.8 cm

- | | |
|-----------|---------|
| | AD / OD |
| 30-100-25 | 2,5 mm |
| 30-100-30 | 3,0 mm |
| 30-100-40 | 4,0 mm |



Eicken Spülröhrchen, lange Biegung, 15 cm
Eicken antrum cannula, long curve, 15 cm

- | | |
|-----------|---------|
| | AD / OD |
| 30-101-25 | 2,5 mm |
| 30-101-30 | 3,0 mm |
| 30-101-40 | 4,0 mm |



Eicken Spülröhrchen, kurze Biegung, 15 cm
Eicken antrum cannula, short curve, 15 cm

- | | |
|-----------|---------|
| | AD / OD |
| 30-102-25 | 2,5 mm |
| 30-102-30 | 3,0 mm |
| 30-102-40 | 4,0 mm |

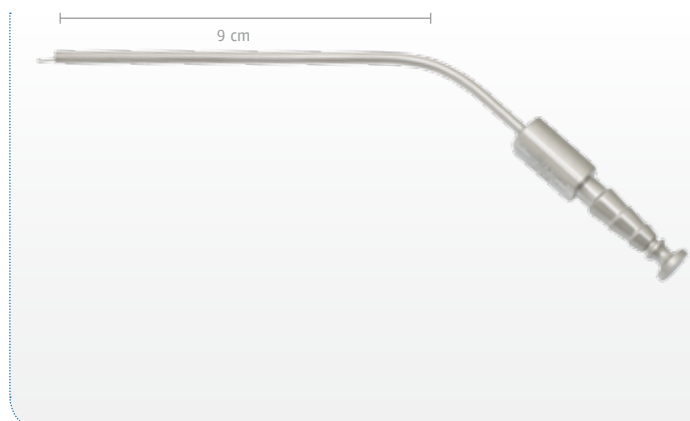

Frazier Saugrohr mit Griffplatte und Unterbrecher, 9 cm
Frazier suction tube with suction control, 9 cm

- | | |
|-----------|-------------------|
| | AD / OD |
| 30-080-05 | 5 Ch/Fr (1,6 mm) |
| 30-080-06 | 6 Ch/Fr (2,0 mm) |
| 30-080-07 | 7 Ch/Fr (2,3 mm) |
| 30-080-08 | 8 Ch/Fr (2,7 mm) |
| 30-080-09 | 9 Ch/Fr (3,0 mm) |
| 30-080-10 | 10 Ch/Fr (3,3 mm) |
| 30-080-12 | 12 Ch/Fr (4,0 mm) |
| 30-080-15 | 15 Ch/Fr (5,0 mm) |





Diagnostic Sinus Instruments

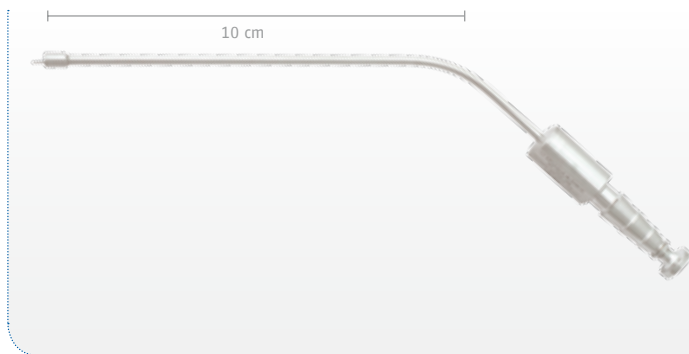

**Frazier Saugrohr,
kniegebogen, Knopfende, 10 cm**
Frazier suction tube,
angled, ball ended, 10 cm

AD / OD

30-082-08	8 Ch/Fr	(2,7 mm)
30-082-10	10 Ch/Fr	(3,3 mm)
30-082-12	12 Ch/Fr	(4,0 mm)
30-082-15	15 Ch/Fr	(5,0 mm)

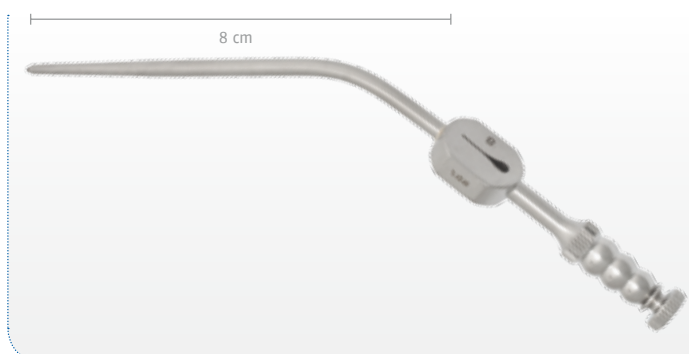

**Frazier Saugrohr, konisch,
mit tränenförmiger Sogsteuerung, 8 cm**
Frazier suction tube, conical,
with tear formed suction control, 8 cm

AD / OD

30-105-06	6 Ch/Fr	(2,0 mm)
30-105-08	8 Ch/Fr	(2,7 mm)
30-105-10	10 Ch/Fr	(3,3 mm)



Stirnhöhlen-Saugrohr, biegsam, 14,5 cm
Frontal sinus suction tube, bendable, 14.5 cm

AD / OD

30-106-25	2,5 mm
30-106-30	3,0 mm
30-106-40	4,0 mm

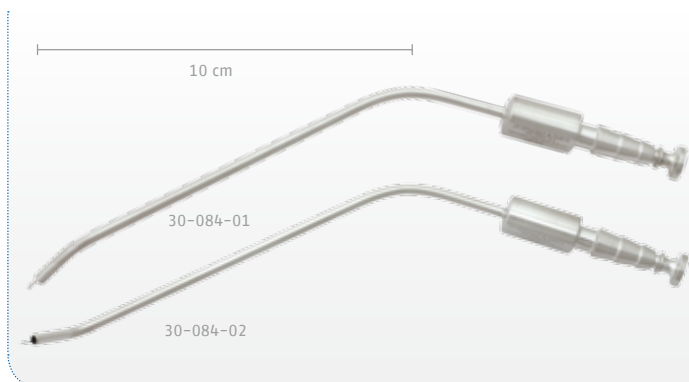

**Frazier Saugrohr mit Unterbrecher,
10 Ch (3,3 mm), 10 cm**
Frazier suction tube with suction control,
10 Ch (3.3 mm), 10 cm

30-084-01	rechts gebogen / curved right
30-084-02	links gebogen / curved left



**Stirnhöhlen Saugraspatorium,
gebogen, biegsam, mit Sogsteuerung, 10 cm**
Frontal sinus suction raspatory,
curved, bendable, with suction control, 10 cm

30-108-00





Diagnostic Sinus Instruments



Eicken Punktionskanüle, 10 cm
Eicken trocar needle, 10 cm

AD / OD

30-110-16	1,6 mm
30-110-18	1,8 mm
30-110-20	2,0 mm



Lichtwitz Punktionskanüle, 10 cm
Lichtwitz trocar needle, 10 cm

AD / OD

30-111-16	1,6 mm
30-111-18	1,8 mm
30-111-20	2,0 mm



Kieferhöhlen-Spülschlauch, 30 cm
Sinus irrigation tube, 30 cm

30-112-00 Silikon mit Ansätzen /
silicone, with connectors



Muck Saugglas mit Stopfen
Muck suction bottle with cap

30-113-00

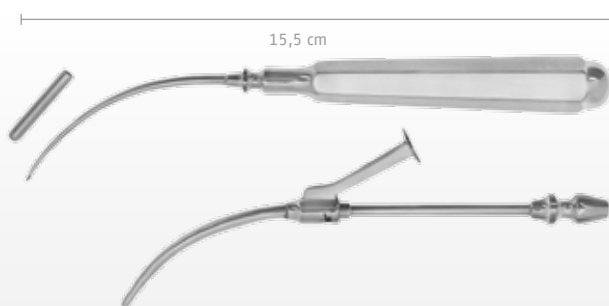

Coakley Kieferhöhlentrokar, 15,5 cm
Coakley sinus trocar, 15.5 cm

30-114-16



Diagnostic Sinus Instruments

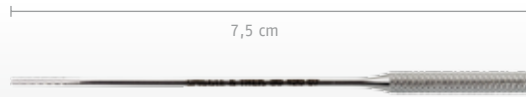

Kieferhöhlen Watteträger, 7,5 cm
Maxillary sinus cotton applicator, 7.5 cm

30-120-07 5 Stück / 5 pieces

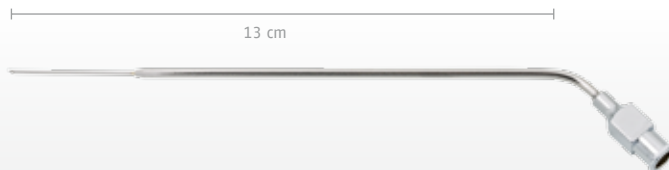

Injektionskanüle, kniegebogen, 13 cm
Injection needle, angled, 13 cm

AD / OD
30-122-08 0,8 mm



Ritter Stirnhöhlenbougie, 15,5 cm
Ritter frontal sinus bougie, 15.5 cm

AD / OD
30-121-25 2,5 mm
30-121-30 3,0 mm
30-121-40 4,0 mm
30-121-50 5,0 mm

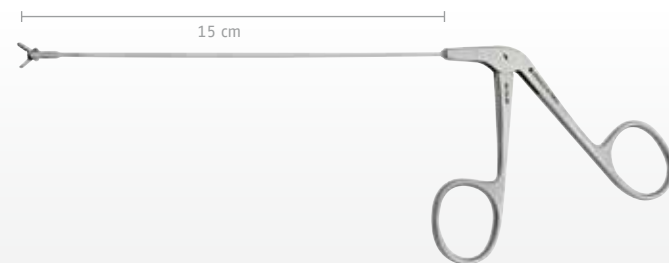

Biopsiezange, gerade, doppelbeweglich, Löffel 2 x 4 mm, Arbeitslänge 15 cm, mit Spülkanal
Biopsy forceps, straight, double-action, cup 2 x 4 mm, working length 15 cm, with irrigation channel

AD / OD
30-125-00 2,5 mm



Optische Biopsiezange, biegsam, zur Verwendung mit Endoskop 2,7 mm, 30°, 14 cm
Optical biopsy forceps, bendable, for use with endoscope 2.7 mm, 30°, 14 cm

30-126-00



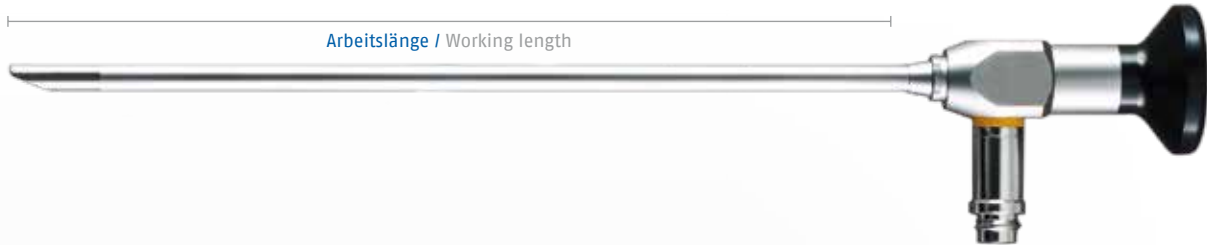

Vorteile unserer Endoskope:

- Kompatibel mit allen Lichtquellen auf dem Markt (universalkompatibel)
- Extrem robuste Rohrkonstruktion mit verstärktem 2-Rohr-Edelstahl-System
- Hochwertig vergütetes, hochauflösendes Linsen-System
- Optische Saphirglas-Frontlinse, kratzfest und hitzebeständig fixiert mit Epoxidharz
- Hitzebeständiges Polymer-Okular (Peek)
- Schnittstellen gelasert = Hohe Dichtigkeit
- Großer Öffnungswinkel = Mehr Bildinformation
- Hohe Bildschärfe im gesamten Bildbereich
- Gleichmäßige Helligkeit bis zum Rand durch Lichtkonus
- Autoklavierbar
- 24 Monate Garantie auf Material- und Produktionsfehler sowie Autoklavierbarkeit

Blickrichtung und Blickwinkel
Viewing direction and angle

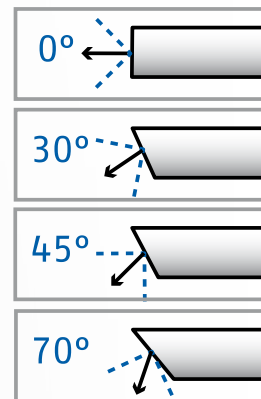

Advantages of our endoscopes:

- Compatible to all light sources available (universal camera compatible)
- Extremely robust stainless steel tube construction with reinforced outer tube
- High precision quality lens system
- Optical sapphire glass front lens, scratch resistant and fixed with heat-resistant epoxide
- Heat-resistant polymer ocular (peek)
- Joints laser welded = tight sealing
- Wide viewing angle = more image information
- High focus quality in entire viewing area
- Constant brightness up to the edge of viewing area
- Autoclavable
- 24 months guarantee against material, production and autoclavability faults

Auch als semiflex-Endoskope erhältlich
Also available as semiflex endoscopes



- Semiflex-Modelle mit Nitinol-Außenhülle, verbesserter Schutz gegen Verbiegen und Bruch
- Semiflex types with nitinol outer tube for improved protection against bending or break

Endoscopy and Video Documentation



Sinuskop,
HD, semiflex, autoklavierbar, AD 2,7 mm, 187,5 mm
Sinuscope,
HD, semiflex, autoclavable, OD 2.7 mm, 187.5 mm

semiflex HD

	Winkel / Angle	
30-131-00	0°	30-131-00
30-131-30	30°	30-131-30

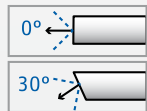

Sinuskop universal,
HD, semiflex, autoklavierbar, AD 2,7 mm, 110 mm
Universal sinuscope,
HD, semiflex, autoclavable, OD 2.7 mm, 110 mm

semiflex HD

	Winkel / Angle	
30-135-00	0°	30-135-00
30-135-30	30°	30-135-30

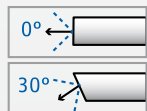

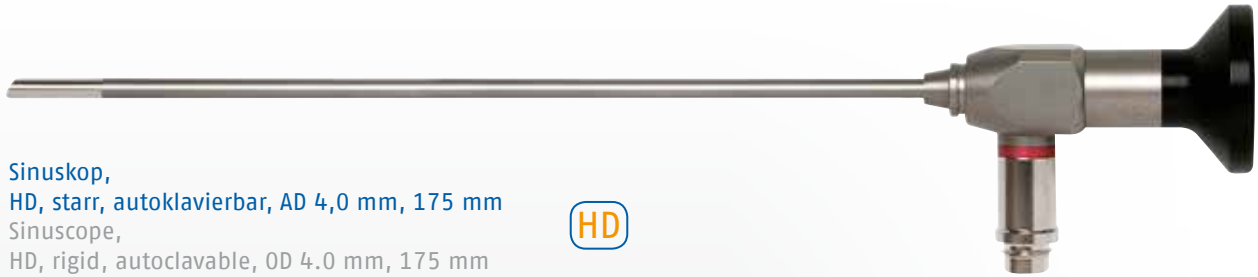

Sinuskop,
HD, starr, autoklavierbar, AD 4,0 mm, 175 mm
Sinuscope,
HD, rigid, autoclavable, OD 4.0 mm, 175 mm

HD

	Winkel / Angle	
30-142-00	0°	 30-142-00
30-142-30	30°	 30-142-30
30-142-45	45°	 30-142-45
30-142-70	70°	 30-142-70

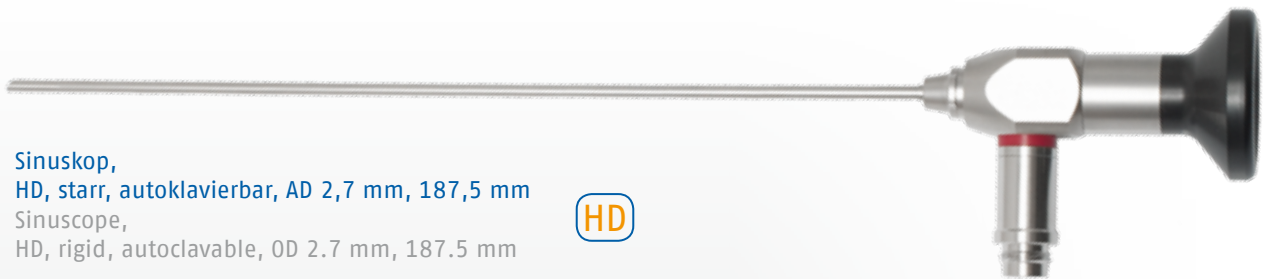

Sinuskop,
HD, starr, autoklavierbar, AD 2,7 mm, 187,5 mm
Sinuscope,
HD, rigid, autoclavable, OD 2.7 mm, 187.5 mm

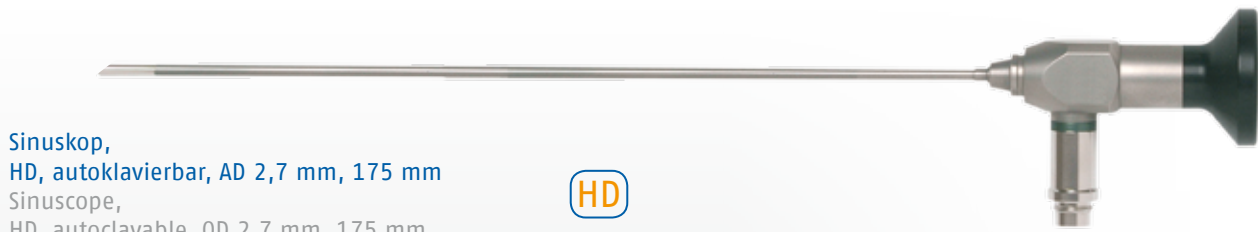

HD

	Winkel / Angle	
30-130-00	0°	 30-130-00
30-130-30	30°	 30-130-30
30-130-70	70°	 30-130-70



Sinuskop,
HD, autoklavierbar, AD 2,7 mm, 175 mm
Sinuscope,
HD, autoclavable, OD 2.7 mm, 175 mm

HD

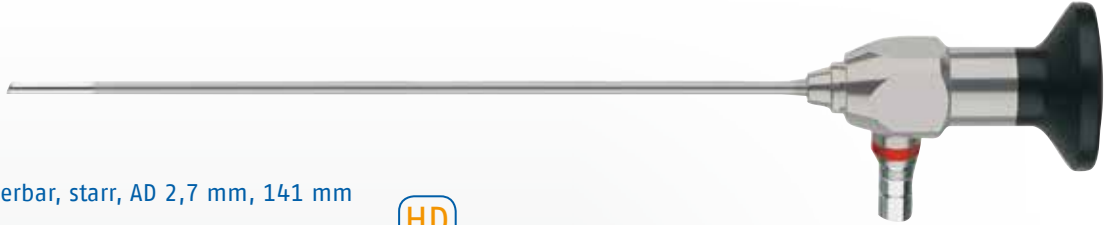

	Winkel / Angle	
10-129-30	30°	 10-129-30
10-129-70	70°	 10-129-70

Endoscopy and Video Documentation



Sinuskop,
HD, autoklavierbar, starr, AD 2,7 mm, 141 mm
Sinuscope,
HD, autoclavable, rigid, OD 2.7 mm, 141 mm



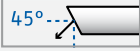

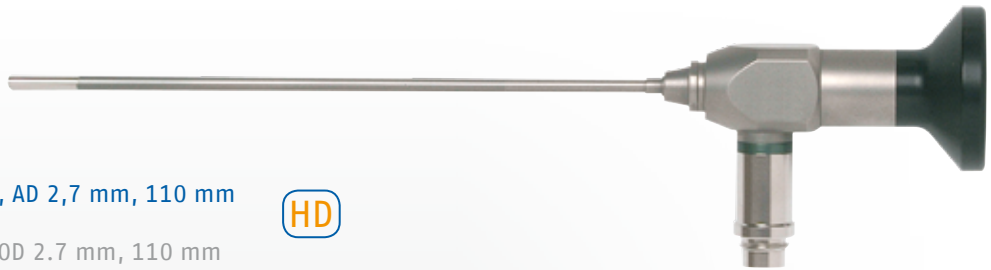

	Winkel / Angle	
30-132-00	0°	 30-132-00
30-132-30	30°	 30-132-30
30-132-45	45°	 30-132-45



Sinuskop universal,
HD, autoklavierbar, starr, AD 2,7 mm, 110 mm
Universal sinuscope,
HD, autoclavable, rigid, OD 2.7 mm, 110 mm



	Winkel / Angle	
30-134-00	0°	 30-134-00
30-134-30	30°	 30-134-30
30-134-45	45°	 30-134-45
30-134-70	70°	 30-134-70



Sterilisations-Container für Endoskope
Ø 2,5 – 5,0 mm, bis 195 mm Länge

Sterilizing & protecting tray for endoscopes
Ø 2.5 – 5.0 mm, up to 195 mm length

80-621-05 für 2 Endoskope / for 2 endoscopes

80-622-56 für 6 Endoskope, 1 Lichtkabel /
for 6 endoscopes, 1 light-cable

80-623-22 für 2 Endoskope, 1 Lichtkabel,
1 Kamerakopf /
for 2 endoscopes, 1 light-cable,
1 camera head



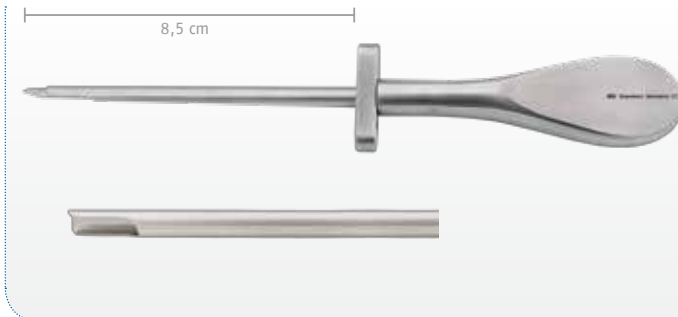

**Antrum-Trokar,
schnabelförmig, 5,0 x 4,0 mm,
AL 8,5 cm, für 4 mm Endoskope**
Antrum trocar,
beaked, 5.0 x 4.0 mm,
WL 8.5 cm, for 4 mm endoscopes

30-155-50

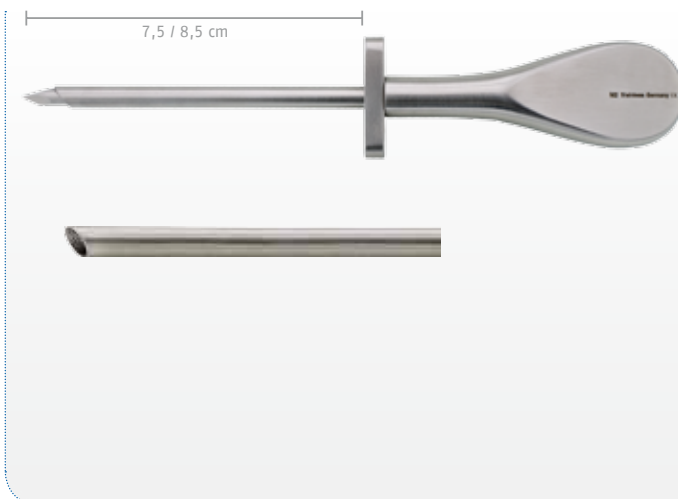

**Antrum-Trokar,
schräges Ende, für Endoskope**
Antrum trocar,
oblique tip, for endoscopes

30-156-33 3,3 x 2,8 mm,
AL 7,5 cm, für 2,7 mm Endoskope /
WL 7.5 cm, for 2.7 mm endoscopes

30-156-40 4,0 x 3,0 mm,
AL 8,5 cm, für 3,0 mm Endoskope /
WL 8.5 cm, for 3.0 mm endoscopes

30-156-50 5,0 x 4,0 mm,
AL 8,5 cm, für 4,0 mm Endoskope /
WL 8.5 cm, for 4.0 mm endoscopes

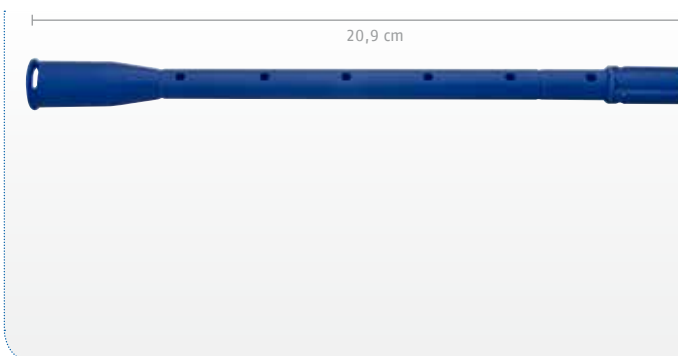

**Endoskop-Schutzhülse,
209 mm, verlängerbar, autoklavierbar,
(für ein Endoskop 40-110-xx oder 40-112-xx.
Für 40-112-xx werden 2 Schutzhülsen benötigt)**
Endoscope protective sleeve,
209 mm, extendable, autoclavable,
(for endoscope 40-110-xx or 40-112-xx.
Two protective sleeves are needed for 40-112-xx)

30-182-21



**Endoskop-Handgriff,
rund, Edelstahl, Griffmulde, 11 cm**
Endoscope handle,
round, stainless steel, moulded grip, 11 cm

30-151-27 für 2,7 mm Endoskope /
for 2.7 mm endoscopes

30-151-40 für 4,0 mm Endoskope /
for 4.0 mm endoscopes

Endoscopy and Video Documentation



Ultra-Stop Antibeschlagmittel
Ultra-Stop Anti-Fog solution

- 30-160-01 25 ml Pipettenflasche, unsteril / 25 ml pipette bottle, non-sterile
- 30-160-02 30 ml Durchstichflasche, steril / 30 ml pierce bottle, sterile
- 30-160-03 15 ml Sprayflasche, unsteril / 15 ml spray bottle, non-sterile



Saug- und Spülhandgriff für Endoskope
Suction- and irrigation handle for endoscopes

30-161-00



Saug- und Spülschaft für Endoskop, 18,5 cm
Suction- and irrigation sheath for endoscopes, 18.5 cm

- 30-164-00 4,0 mm, 0°
- 30-164-30 4,0 mm, 30°
- 30-164-45 4,0 mm, 45°
- 30-164-70 4,0 mm, 70°
- 30-167-00 2,7 mm, 0°
- 30-167-30 2,7 mm, 30°

LED-Leuchtgriffe
LED light handles



- 70-211-00 LED-Hochleistungs-Leuchtgriff, 230 V, bestehend aus: (70-211-10, 70-211-20, 70-211-30, 70-211-40) / LED high performance light-handle, 230 V, consisting of: (70-211-10, 70-211-20, 70-211-30, 70-211-40)
- 70-211-01 LED-Hochleistungs-Leuchtgriff, 120 V, bestehend aus: (70-211-10, 70-211-20, 70-211-30, 70-211-50) / LED high performance light-handle, 120 V, consisting of: (70-211-10, 70-211-20, 70-211-30, 70-211-50)
- 70-211-10 LED-Handgriff, schwarz, mit Helligkeitsdimmer, Ausschaltautomatik, 3 W, 5500°K, 17500 Lux, zur Verwendung mit Li-Io-Akku 3,5 V und Endoskop-Adapter, 50 Std. Brenndauer / LED light handle, black, with brightness dimmer, automatic switch-off, 3 W, 5500° K, 17500 lux, to use with Li-Io chargeable battery 3.5 V and endoscope adapter, 50 hours run-time
- 70-211-20 Li-Ionen-Akku, 3,5 V, für LED-Handgriff / Li-ion rechargeable battery, 3.5 V, for LED light-handle
- 70-211-30 Endoskopie-Adapter für LED-Handgriff, passend für Standardgewinde an Endoskopen (AcMI-Gewinde) / Endoscope adapter for LED light-handle, fits standard endoscope threads (AcMi-thread)
- 70-211-40 Ladegerät für bis zu 2 LED-Handgriffe, 3,5 V, 230 V, Standgerät, Wandhalterung / Charging base for up to 2 LED light-handles, 3.5 V, 230 V, table model, with wall holder
- 70-211-50 Ladegerät für bis zu 2 LED-Handgriffe, 3,5 V, 120 V, Standgerät, Wandhalterung / Charging base for up to 2 LED light-handles, 3.5 V, 120 V, table model, with wall holder





Flexibles Nasopharyngoskop
Flexible nasopharyngoscop

Schaftdurchmesser	3,4 mm
Shaft diameter	3.4 mm
Arbeitslänge	32 cm
Working length	32 cm
Abwinkelung (auf / ab)	130°
Angle (up / down)	130°
Biegeradius	8 mm
Bending radius	8 mm
Blickfeld	80°
Field of vision	80°
Tiefenschärfe	1–50 mm
Depth of focus	1–50 mm
Gewicht	230 g
Weight	230 g

30-170-28	2,8 mm	
30-170-36	3,4 mm	
30-171-40	4,0 mm	mit Arbeitskanal / with working channel

Die Spiggle & Theis Nasopharyngoskope der neuen Generation sind intuitiv bedienbar und ergonomisch optimal geformt, entwickelt für die notwendige Feinfühligkeit im täglichen Routineeinsatz und eine ermüdungsfreie Handhabung.

Hochwertige Bildleiter und ein leistungsfähiges optisches System liefern große und helle Bilder bester Auflösung – die Voraussetzung für eine sichere Diagnose und Therapie. Dank solider Verarbeitung und konsequenter Verwendung moderner Hochleistungswerkstoffe sind Spiggle & Theis Nasopharyngoskope robuster und langlebiger – trotz steigender Belastung durch moderne Aufbereitungsverfahren.

The new generation Spiggle & Theis nasopharyngoscopes impress with intuitive operability and optimal ergonomics, designed for tactile sensation and non-tiring handling as required in daily routine operations.

High-end fibre-optic bundles and a high-capacity system produce large and bright images of the best quality – necessary for safe diagnosis and treatment. Due to the constant use and reliable processing of high-class materials, the Spiggle & Theis nasopharyngoscopes are robust and durable, in spite of the increasing stress of modern cleaning and sterilizing facilities.

- funktionelles Design für eine entspannte, angenehme Handhabung
- feinfühlig, aber robuste Steuerung
- optimale Flexibilität und Torsionssteifigkeit des Einführungsschafts
- leistungsfähiges optisches System: größere, hellere und schärfere Bilder
- geeignete Wiederaufbereitungsverfahren:
 - einlegbar in Reinigungs- und Desinfektionslösung
 - STERIS
 - NTFD-Sterilisation = Niedertemperatur-Dampf-Formaldehyd-Sterilisation
 - maschinelle Aufbereitung (RDG-E)
- functional design for easy and comfortable handling
- sensitive yet robust control
- optimal flexibility and torsional rigidity of the insertion channel
- high-performance optical system for larger, brighter and sharper images
- suitable reprocessing procedures:
 - fully immersible in cleaning and disinfectant solutions
 - STERIS
 - LTSF-sterilization = Low-Temperature Steam and Formaldehyde-sterilization
 - machine reprocessing (RDG-E)



Flexibles Nasopharyngoskop
Flexible nasopharyngoscope

30-170-28 2,8 mm \varnothing ,
32 cm Arbeitslänge /
Working length

Flexibles Nasopharyngoskop
Flexible nasopharyngoscope

30-171-40 4,0 mm \varnothing ,
1,4 mm \varnothing Arbeitskanal /
Working channel,
32 cm Arbeitslänge /
Working length

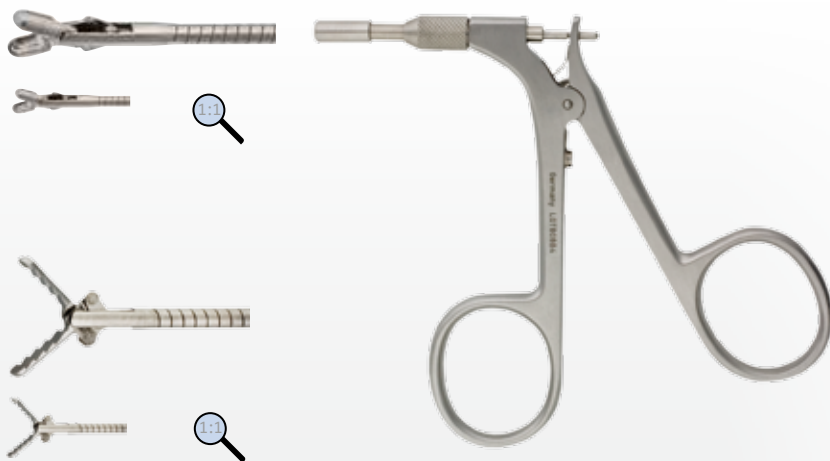

Flexible Löffelzange, 1,2 mm, 40 cm, Ringgriff, ovales Löffelmaul
Flexible cup forceps, 1.2 mm, 40 cm, ring handle, oval cups

30-172-40

Flexible Alligatorzange, 1,2 mm, 40 cm, Ringgriff, gezahntes Maul
Flexible alligator forceps, 1.2 mm, 40 cm, ring handle, toothed jaws

30-173-40



Flexible Reinigungsbürste mit Ringgriff, einseitig, 1,2 mm, 40 cm, für flexibles Nasopharyngoskop 30-171-40
Flexible cleaning brush with ring handle, one-sided, 1.2 mm, 40 cm, for flexible nasopharyngoscope 30-171-40

30-174-40



70-109-00 HD-Kamera und Dokumentations-System bestehend aus: HD-Camera und Documentation-System consisting of:

70-115-00 High Definition Endoskopie-Kamera,
USB 3.0 Anschluss, Auflösung 1280x720p (60fps), Sensor 1/2.9" Sony CCD /
High Definition Endoscopy-Camera,
USB 3.0 connection, resolution 1280x720p (60fps), Sensor 1/2.9" Sony CCD

- 1/2.9" CMOS SONY Sensor
- HD
- Bit resolution: ITU-R BT.1120
- Pixel: 1312(H) x 1069(V) ~ 1.31M pixel
- Unit cell size: 1305(H) x 1049(V)
- 16:9
- Empfindlichkeit / Sensitivity: 2450mV
- 2:1 Interlaced
- Sync system intern
- Auflösung / Resolution: 1280 x 720p, 60 fps
- Video output: USB 3.0 UVC support YuY2 1280 x 720 / 60 fps
- Signal/Noise ratio: 50 dB
- Gamma: 0.45 ~ 1
- Shutter: 1/50 ~ 1/100.000 sec
- Automatischer Weißabgleich / Automated white balance
- Stromversorgung / Power supply USB 5.0 V
- Stromverbrauch Typ 260mA (+5.0 V) / Power consumption



- 70-020-21 TV-Adapter, HD, f=21 mm, c-mount, einlegbar /
TV-adapter, HD, f=21 mm, c-mount, soakable
- 70-111-00 Medizinischer All-in-One-PC,
21,5", 1920 x 1080 p, IC i7, touch screen, 4GB DDR3, 500 GB HDD /
Medical grade all-in-one-pc,
21.5", 1920 x 1080 p, IC i7, touch screen, 4GB DDR3, 500 GB HDD
- 70-111-05 MediaWorkStation 2.9D, Vorinstallation und Funktionskontrolle /
MediaWorkStation 2.9D, preinstallation and function control
- 70-111-10 MediaWorkStation 2.9D, Software für HD/SD Video- und Bildspeicherung, Patientenverwaltung,
Befundverwaltung, Bildbearbeitung, Druck /
MediaWorkStation 2.9D, software for HD/SD video- and picture documentation,
patient administration, archiving of indication, editing, print
- 70-111-30 Fußschalter, USB, 2 Pedale zur Bild- bzw. Videospeicherung /
Footswitch, USB, 2 pedals, for picture- and video documentation
- 70-111-40 VESA Standfuß für All-in-One-PC /
VESA stand for all-in-one-pc
- 70-111-50 Tastatur DE, USB /
Keyboard DE, USB
- 70-111-60 Optische Maus, USB /
Optical mouse, USB
- 70-113-00 MediaWorkStation
MediaWorkStation



Endoscopy and Video Documentation



LED Lichtquelle R 100 duo,
2 x 100 Watt, 230 V,
automatische Helligkeitsregelung
LED light source R 100 duo,
2 x 100 watt, 230 V,
automatic brightness control

70-203-00



Hochleistungs-Fiberglas-Lichtleitkabel,
ø 3,5 mm, 1800 mm, 90°
High definition fibre light cable,
ø 3.5 mm, 1800 mm, 90°

70-265-01 **Wolf/Wolf-Adapter /**
Wolf/Wolf connector
70-265-02 **Storz/Storz-Adapter /**
Storz/Storz connector



Hochleistungs-Fiberglas-Lichtleitkabel,
ø 3,5 mm, ST/ST-Anschlüsse, autoklavierbar
High definition fibre light cable,
ø 3.5 mm, ST/ST-connections, autoclavable

70-258-35 1800 mm
70-259-35 2300 mm
70-260-35 3000 mm

Weitere Lichtleitkabel und Adapter auf Anfrage / More light cables and connectors on request



Desinfektions-Wandhalterung
für flexible Endoskope, 4 Glasköcher,
Aufhängung höhenverstellbar, Timer,
233 x 750 x 60 mm (Lieferung ohne Endoskop)
Disinfection wall holder,
for flexible endoscopes, 4 glass tubes,
hanging height adjustable, timer,
233 x 750 x 60 mm (Delivery without endoscope)

70-472-00



Desinfektionssystem für starre und flexible Endoskope,
720 x 120 x 60-120 mm
Disinfection system for rigid and flexible endoscopes,
720 x 120 x 60-120 mm

70-470-00



Killian-Struycken Septumspekulum, 13,5 cm
Killian-Struycken septum speculum, 13.5 cm

Blattlänge / Length of blade

20-150-40	40 mm
20-150-55	55 mm
20-150-75	75 mm
20-150-90	90 mm

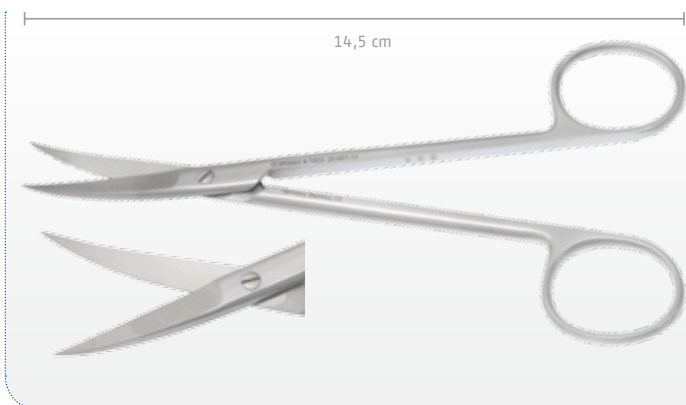

Joseph Schere, spitz-spitz, gebogen 14,5 cm
Joseph scissors, pointed, curved, 14.5 cm

20-601-14

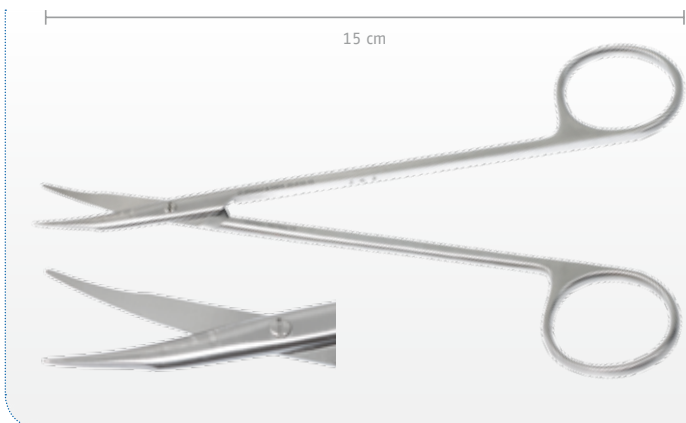

Reynolds Schere, stumpf-stumpf, gebogen, verjüngte Spitzen, 15 cm
Reynolds scissors, blunt-blunt, curved, tapered tips, 15 cm

20-610-15



Walter Schere, abgewinkelt, 10 cm
Walter scissors, angled, 10 cm

20-630-10

Septum Instruments

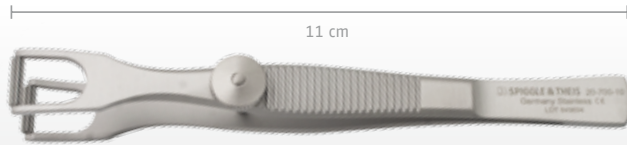

Cottle Columella-Klemme, 11 cm
Cottle columella forceps, 11 cm

20-700-10

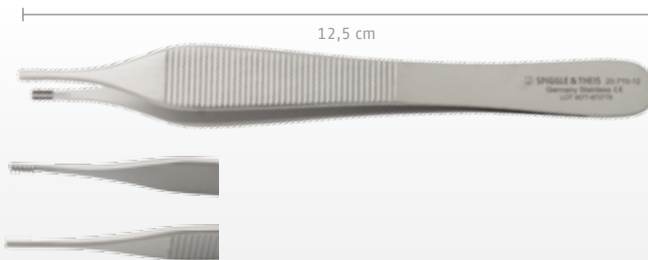

Adson-Brown Pinzette, 7:8 Zähne, 12,5 cm
Adson-Brown forceps, 7:8 teeth, 12.5 cm

20-710-12

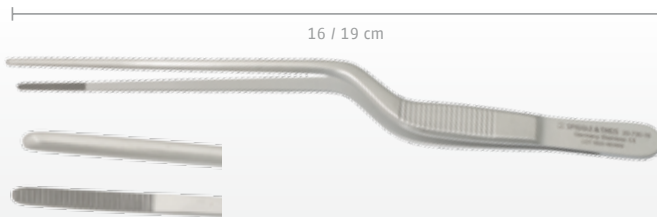

Jansen Nasenpinzette, bajonett, anatomisch
Jansen nasal forceps, bayonet, anatomical

20-730-16 16 cm
20-730-19 19 cm

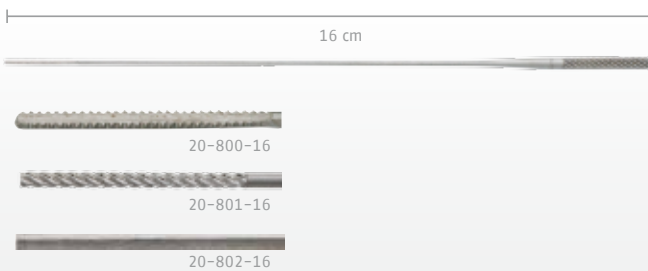

Watteträger, ø 1,2 mm, 16 cm, 5 Stück
Cotton carrier, ø 1.2 mm, 16 cm, 5 pieces

20-800-16 dreikant, gerieft / triangle, serrated
20-801-16 rund, gerieft / round, serrated
20-802-16 dreikant, glatt / triangular, smooth



Cottle Septum-Messer, 14 cm
Cottle septum knife, 14 cm

20-500-13



Masing Ritzmesser, 14 cm
Masing pointed knife, 14 cm

20-501-14 mit Kerbe / grooved
20-502-14 glatt / smooth

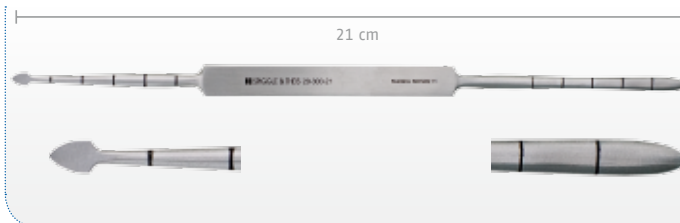

Masing Elevatorium/Raspatorium, 21 cm
Masing elevator/raspatory, 21 cm

20-300-21

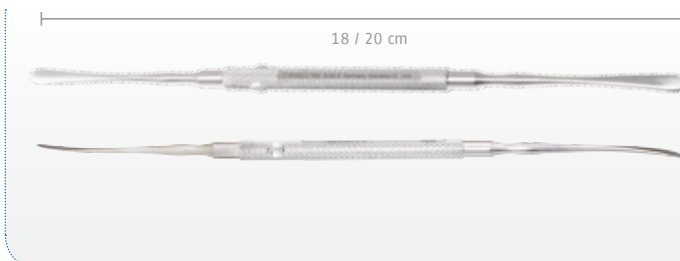

Freer Doppelevatorium, scharf-stumpf

Freer elevator, double ended, sharp-blunt

20-305-18 18 cm
20-306-20 20 cm



Weber Doppelevatorium, scharf/stumpf, 18,5 cm

Weber elevator, double ended, sharp/blunt, 18.5 cm

20-307-18



Guillen Saugraspatorium, 4 mm
Guillen suction raspatory, 4 mm

20-322-01 20 cm, gerade / straight
20-322-02 20 cm, links gebogen / curved left
20-322-03 21,5 cm, rechts gebogen / curved right
20-323-01 15 cm, gerade / straight
20-323-02 15 cm, links gebogen / curved left
20-323-03 15 cm, rechts gebogen / curved right



Cottle Hammer, Hammerkopf aus spezialgehärtetem Stahl, 18 cm
Cottle mallet, hammerhead made of special tempered steel, 18 cm

20-400-18

Septum Instruments

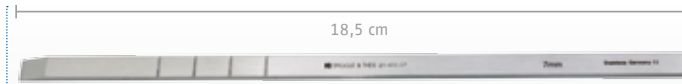

Cottle Meißel, flach, 18,5 cm
Cottle chisel, flat, 18.5 cm

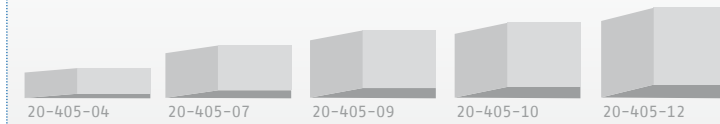

20-405-04	4 mm
20-405-07	7 mm
20-405-09	9 mm
20-405-10	10 mm
20-405-12	12 mm



Crile-Wood Nadelhalter, Hartmetall, 15 cm
Crile-Wood needleholder, tungsten carbide, 15 cm

20-740-15

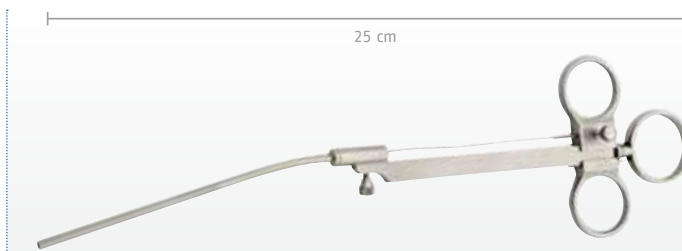

Krause Nasen-Polypen-Schnürer, scharf, 25 cm
Krause nasal polyp snare, sharp, 25 cm

20-190-25



Nasenpolypenschlingen, 0,35 mm, 10 cm, 100 Stück
Nasal polyp snare wires, 0.35 mm, 10 cm, 100 pieces

20-195-35



Nasensonde, s-förmig gebogen, biegsam, 18,5 cm
Nasal probe, s-shaped, bendable, 18.5 cm

20-313-00



Cottle Nasenflügelhaken, 16,5 cm
Cottle alar retractor, 16.5 cm

20-560-15



Bipolare Pinzette, NON-STICK, bajonett, Spitze 0,5 mm, 16 cm
Bipolar forceps, NON-STICK, bayonet, tip 0.5 mm, 16 cm

80-110-16



Bipolares Anschlusskabel, 4 m, passend für EMC/Dolley, autoklavierbar
Bipolar connecting cable, 4 m, compatible with EMC/Dolley, autoclavable

80-016-45



Bipolares Anschlusskabel, 4,5 m, passend für Sutter/Martin/Berchtold/Aesculap, autoklavierbar
Bipolar connecting cable, 4.5 m, compatible with Sutter/Martin/Berchtold/Aesculap, autoclavable

80-017-45



Bipolares Anschlusskabel, 4,5 m, passend für Erbe/Storz
Bipolar connecting cable, 4.5 m, compatible with Erbe/Storz

80-018-45



Bipolares Anschlusskabel, 4,5 m, passend für Valleylab/Lamidey/Coa/Söring/Olympus/Bowa/Vio
Bipolar coagulation cable, 4.5 m, compatible with Valleylab/Lamidey/Coa/Söring/Olympus/Bowa/Vio

80-019-45

Septum Instruments







Premium Modell
Premium model

- ◆ schlanker Schaft / slim shank
- ◆ schmales Maulteil / slender jaw
- ◆ besonders feine Ausarbeitung / smooth finish

Blakesley Nasenzange Premium, gerade, 11,5 cm
Blakesley premium nasal forceps, straight, 11.5 cm

Größe / Size

20-215-00	3,0 mm	
20-215-01	3,5 mm	
20-215-02	4,0 mm	
20-215-03	5,0 mm	
20-215-04	6,0 mm	







Premium Modell
Premium model

- ◆ schlanker Schaft / slim shank
- ◆ schmales Maulteil / slender jaw
- ◆ besonders feine Ausarbeitung / smooth finish

Blakesley Nasenzange Premium, 45° aufgebogen, 11,5 cm
Blakesley premium nasal forceps, curved upwards 45°, 11.5 cm

Größe / Size

20-225-00	3,0 mm	
20-225-01	3,5 mm	
20-225-02	4,0 mm	
20-225-03	5,0 mm	
20-225-04	6,0 mm	





Premium Modell
Premium model

- ◆ schlanker Schaft / slim shank
- ◆ schmales Maulteil / slender jaw
- ◆ besonders feine Ausarbeitung / smooth finish

Blakesley Nasenzange Premium, 90° aufgebogen, 11,5 cm
Blakesley premium nasal forceps, curved upwards 90°, 11.5 cm

Größe / Size

20-235-01	3,5 mm	
20-235-02	4,0 mm	
20-235-03	5,0 mm	





**Blakesley Nasenzange,
45° aufgebogen, 15 cm**
Blakesley nasal forceps,
curved upwards 45°, 15 cm

Größe / Size

- | | | |
|-----------|--------|---|
| 20-225-11 | 3,5 mm |  |
| 20-225-12 | 4,5 mm |  |
| 20-225-14 | 6,0 mm |  |



Hartmann Nasentamponadezange
Hartmann nasal dressing forceps

- | | |
|-----------|------------------------|
| 20-200-16 | 16 cm, fein / delicate |
| 20-200-20 | 20 cm |



**Wigand Polypen-Fasszange,
60° aufgebogen, 11,5 cm**
Wigand polyp-grasping forceps,
60° angled, 11.5 cm

20-236-00

Septum Instruments



Strümpel-Voss Nasenzange,
45°, 11,5 cm
Strümpel-Voss nasal forceps,
45°, 11.5 cm

20-238-00

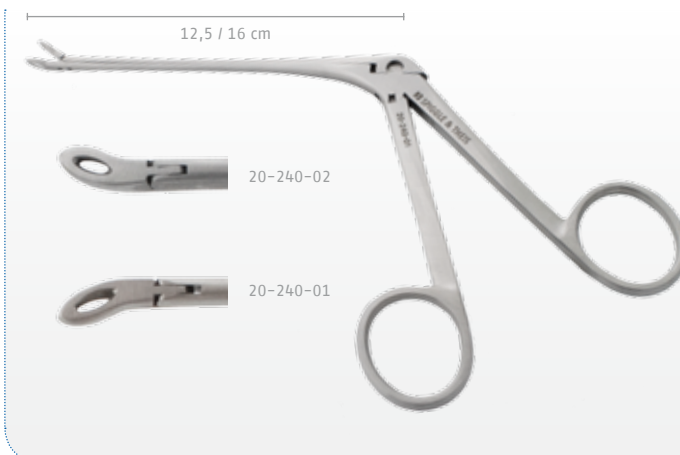

Blakesley Nasenzange
Blakesley nasal forceps

- 20-240-01 12,5 cm, links gebogen / curved left
- 20-240-02 12,5 cm, rechts gebogen / curved right
- 20-240-11 16,0 cm, links gebogen / curved left
- 20-240-12 16,0 cm, rechts gebogen / curved right



Takahashi Nasenzange
Takahashi nasal forceps

- 20-245-01 11,5 cm 2,5 mm gerade / straight
- 20-245-11 15,0 cm 2,5 mm gerade / straight
- 20-245-02 11,5 cm 2,5 mm 30° aufgebogen / 30° curved upwards
- 20-245-12 15,0 cm 2,5 mm 30° aufgebogen / 30° curved upwards
- 20-246-01 11,5 cm 4,0 mm gerade / straight
- 20-246-02 11,5 cm 4,0 mm 30° aufgebogen / 30° curved upwards





**Sichelmesser,
gerader Schaft, 19,5 cm**
Sickle knife,
straight shaft, 19.5 cm

- 30-200-01 spitz / pointed
- 30-200-02 abgerundet / rounded
- 30-200-03 links gebogen, spitz /
curved left, pointed
- 30-200-04 rechts gebogen, spitz /
curved right, pointed



**Antrum-Kürette,
gerader Schaft, 19 cm**
Antrum curette,
straight shaft, 19 cm

- 30-203-01 vorwärts schneidend /
forward cutting
- 30-203-02 rückwärts schneidend /
backward cutting

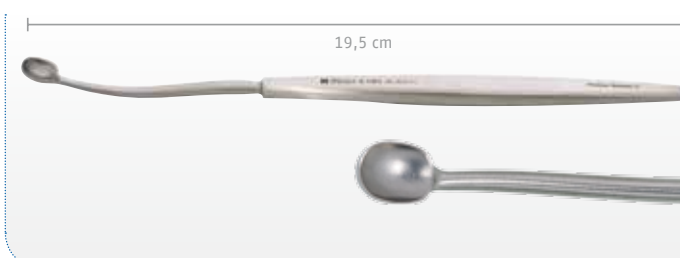

**Antrum-Löffel,
oval, 7,0 x 10,5 mm, gebogen, 19,5 cm**
Antrum curette,
oval, 7.0 x 10.5 mm, curved, 19.5 cm

30-205-01



**Antrum-Löffel,
längsoval, 45° gewinkelt, 19,5 cm**
Antrum curette,
oval, 45° angled, 19.5 cm

- 30-205-02 klein (2,5 x 6,0 mm) / small
- 30-205-03 groß (4,0 x 9,0 mm) / large

FESS-Instruments

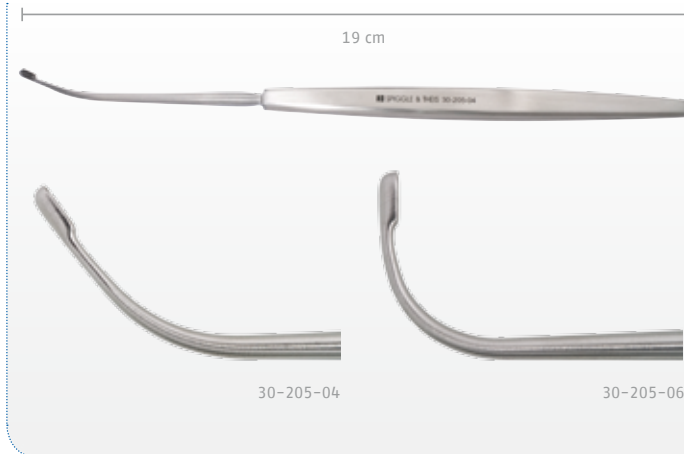

Stirnhöhlen-Löffel,
gerader Schaft, längsoval,
Löffelgröße 2,5 x 6,0 mm, 19 cm
Frontal sinus curette,
straight shaft, oval,
tip size 2.5 x 6.0 mm, 19 cm

30-205-04 55° aufgebogen /
55° curved upwards
30-205-06 90° aufgebogen /
90° curved upwards
30-205-70 70° aufgebogen /
70° curved upwards



Wigand Stirnhöhlenraspel, 21 cm
Wigand frontal sinus rasp, 21 cm

30-209-01

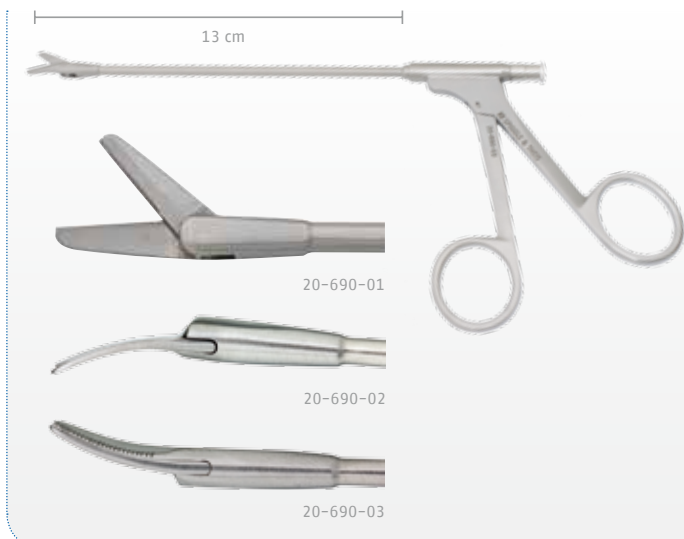

Conchotomie Schere,
gezahnt, Rohrschaft,
mit Spülkanal, 13 cm
Nasal conchotomy scissors,
toothed, tubular model,
with irrigation channel, 13 cm

20-690-01 gerade / straight
20-690-02 links gebogen / curved left
20-690-03 rechts gebogen / curved right

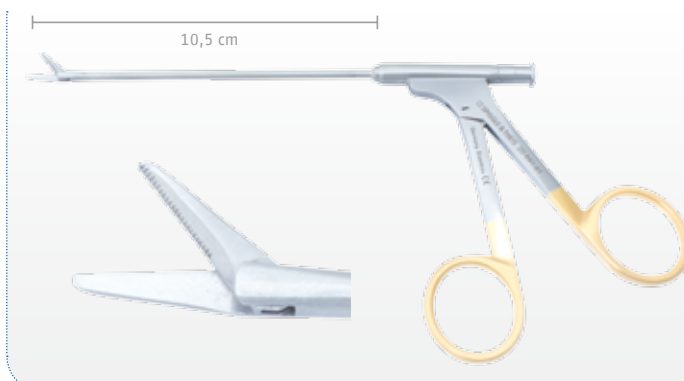

Weber Nasenschere,
extra fein, gerade,
mit Spülkanal, 10,5 cm
Weber nasal scissors,
very fine, straight,
with irrigation channel, 10.5 cm

20-691-01



**Stirnhöhlensonde,
doppelseitig, leicht gebogen, 21 cm**
Frontal sinus seeker,
double ended, slightly curved, 21 cm

30-207-01



**Kieferhöhlensonde,
doppelseitig, 19 cm**
Maxillary sinus seeker,
double ended, 19 cm

30-207-02



**Stirnhöhlensonde,
doppelseitig, stark gebogen, 22 cm**
Frontal sinus seeker,
double ended, strongly curved, 22 cm

30-207-03

FESS-Instruments

Spiggle & Theis Medizintechnik GmbH legt besonderen Wert darauf, dass alle Instrumente und Endoskope nach validierten Verfahren aufbereitet werden können. Dies bezieht sich sowohl auf die Reinigung als auch auf die Sterilisation der Produkte. Innovative Lösungen wie Spülkanäle in Rohrschaft-Instrumenten oder Zerlegbarkeit von Zangen und Stanzen belegen unsere Vorreiterrolle in diesem Bereich.

It is of special importance to Spiggle & Theis Medizintechnik GmbH that all our instruments and endoscopes can be processed in accordance with accepted validation methods, regarding both the cleaning and the sterilization of the products. Our pioneering position in this field is supported by such innovative solutions as irrigation channels in tube-shaft instruments as well as detachable slide-bar instruments for forceps and punches.

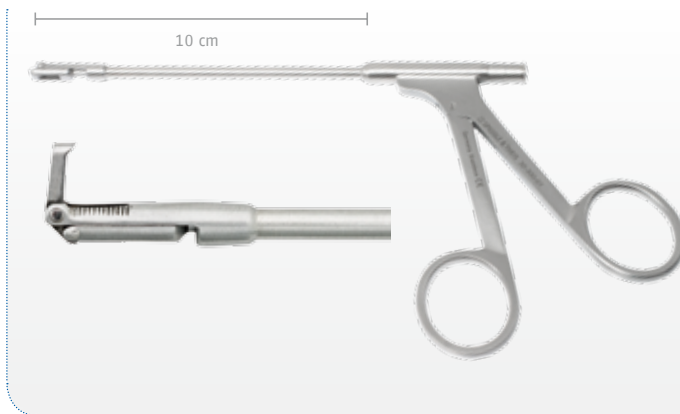

**Antrumstanze,
rückwärts schneidend,
2,5 mm, mit Spülkanal, 10 cm**
Antrum punch,
backward cutting, 2.5 mm,
with irrigation channel, 10 cm

- 30-300-01 Gerade schneidend / straight cutting
- 30-300-02 Links schneidend / left cutting
- 30-300-03 Rechts schneidend / right cutting



**Antrumstanze,
rückwärts schneidend, gerade,
1,5 mm, 10 cm, mit Spülkanal**
Antrum punch,
backward cutting, straight, 1.5 mm,
10 cm, with irrigation channel

- 30-302-01 Gerade schneidend / straight cutting
- 30-302-02 Links schneidend / left cutting
- 30-302-03 Rechts schneidend / right cutting

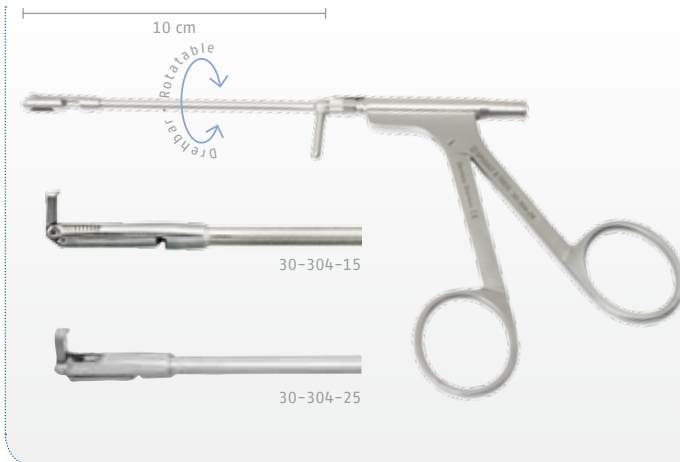

**Antrumstanze,
rückwärts schneidend,
drehbar, 2,5 mm, mit Spülkanal, 10 cm**
Antrum punch,
backward cutting, rotatable,
2.5 mm, with irrigation channel, 10 cm

30-304-15 1,5 mm
30-304-25 2,5 mm

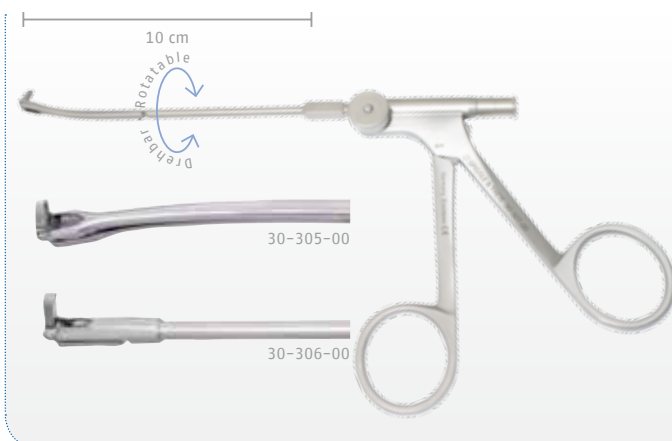

**Tobey Mikro-Antrumstanze,
rückwärts schneidend, drehbar,
mit Spülkanal, 10 cm**
Tobey micro antrum punch,
backward cutting, rotatable,
with irrigation channel, 10 cm

30-305-00 Schaft abwärts gebogen /
downwards curved shaft
30-306-00 gerader Schaft / straight shaft
30-307-00 Schaft aufwärts gebogen /
upwards curved shaft

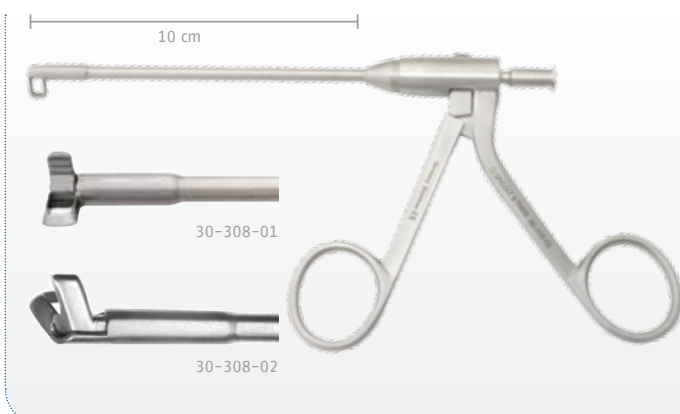

**Antrumstanze,
seitwärts schneidend, 10 cm**
Antrum punch,
sideways cutting, 10 cm

30-308-01 links schneidend / left cutting
30-308-02 rechts schneidend / right cutting

FESS-Instruments

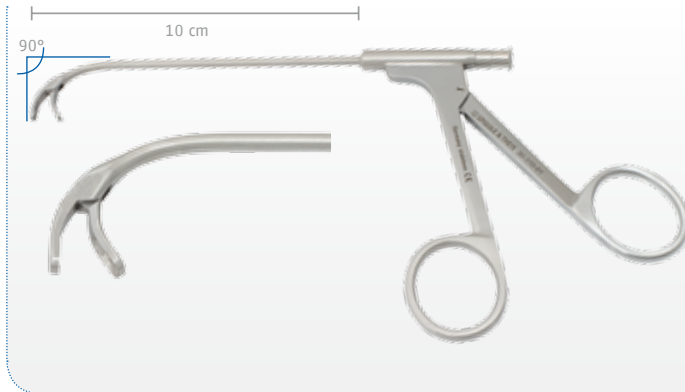

Kieferhöhlen Polypen-Fasszange, rückwärts öffnend, mit Spülkanal, 10 cm
 Antrum polyp grasping forceps, retrograde opening, with irrigation channel, 10 cm

30-310-01

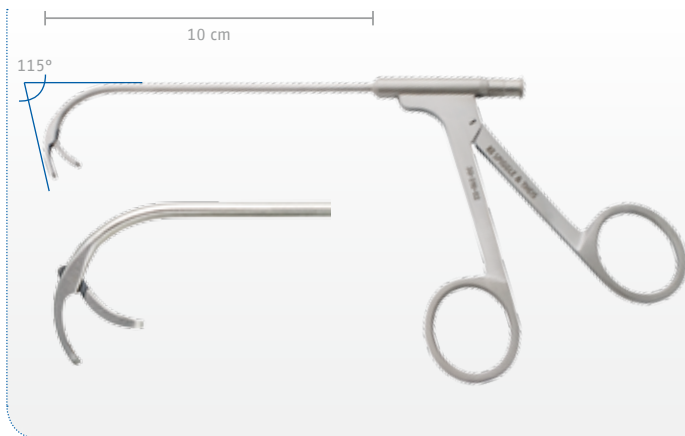

Kieferhöhlen Polypen-Fasszange, rückwärts öffnend, extra langer Schaftbogen, mit Spülkanal, 10 cm
 Antrum polyp grasping forceps, retrograde opening, extra long shaft curve, with irrigation channel, 10 cm

30-310-02

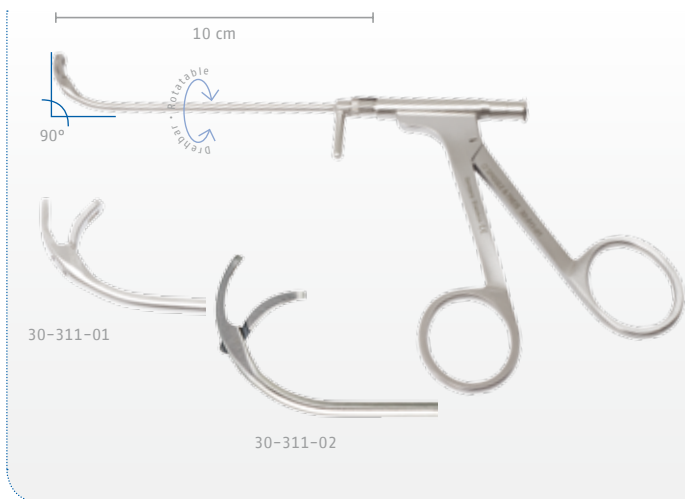

Kieferhöhlen Polypen-Fasszange, rückwärts öffnend, drehbar, 10 cm
 Antrum polyp grasping forceps, retrograde opening, rotatable, 10 cm

30-311-01 normaler Schaft / normal shaft
 30-311-02 extra langer Schaftbogen / extra long shaft curve





Durchschneidende Nasenzange
Throughcutting nasal forceps

- **Stumpfes Ende = Dura-Schutz**
- **Blunt end = dura protection**

11,5 / 14 cm



30-320-02

		Größe / Size	Länge / Length
	30-320-01 gerade / straight	5,0 x 1,5 mm	14,0 cm
	30-320-02 gerade / straight	6,5 x 2,5 mm	11,5 cm
	30-321-01 60° gewinkelt / 60° angled	5,0 x 1,5 mm	14,0 cm
	30-321-02 60° gewinkelt / 60° angled	6,5 x 2,5 mm	11,5 cm
	30-322-01 Aufgebogen / curved upwards	5,0 x 1,5 mm	14,0 cm
	30-322-02 Aufgebogen / curved upwards	8,0 x 3,0 mm	14,0 cm



30-320-01



30-321-01



30-322-01



30-320-02



30-321-02



30-322-02

14 cm



**Löffelzange,
aufgebogen, kräftig, 6,5 x 2,5 mm, 14 cm**
Cup Forceps,
curved upwards, robust, 6.5 x 2.5 mm, 14 cm

30-328-01

FESS-Instruments



Wigand durchschneidende Zange, flach, abgerundet, 14 cm
Wigand throughcutting forceps, flat, rounded, 14 cm

- 30-330-01 4,0 x 3,0 mm, gerade / straight
30-330-02 4,0 x 3,0 mm, 45° aufgewinkelt / 45° angled

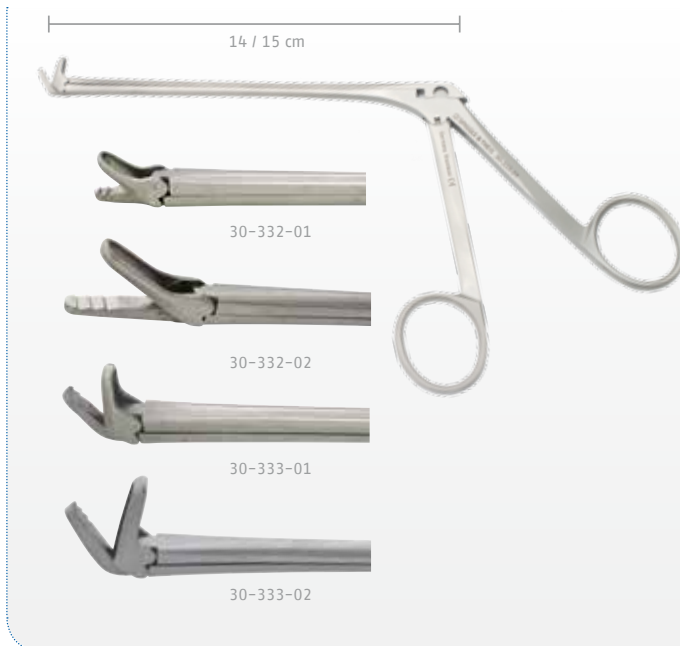

Herberhold cranial durchschneidende Zange, flach
Herberhold cranial throughcutting forceps, flat

- 30-332-01 6,0 x 2,0 mm, 14 cm, gerade / straight
30-332-02 11,5 x 2,5 mm, 14 cm, gerade / straight
30-333-01 6,0 x 2,0 mm, 14 cm, 60° aufgebogen / 60° curved upwards
30-333-02 11,5 x 2,5 mm, 14 cm, 60° aufgebogen / 60° curved upwards
30-332-12 11,5 x 2,5 mm, 15 cm, gerade / straight
30-333-12 11,5 x 2,5 mm, 15 cm, 60° aufgebogen / 60° curved upwards

- Beschleunigung der OP, da Stanzmaterial nach oben ausgeworfen wird
- Unterer Block (feststehend) kann wie Trocar verwendet werden
- Zahnung verhindert Wegrutschen
- Quicker surgery as punched material is ejected upwards
- Lower block (fixed) can be used as trocar
- Serration prevents slipping

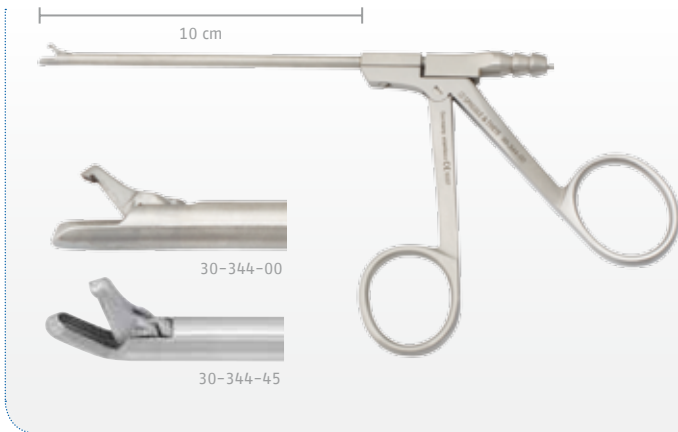

Durchschneidende Saugzange, 10 cm
Throughcutting suction forceps, 10 cm

- 30-344-00 gerade / straight
- 30-344-45 45° aufgewinkelt / 45° angled

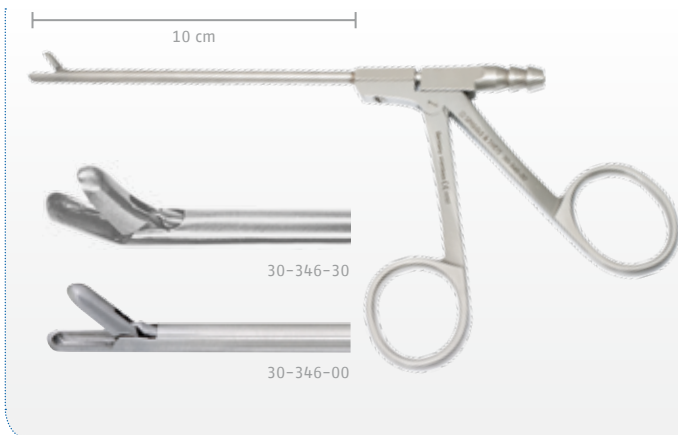

Takahashi Nasenzange mit Saugkanal, 10 cm
Takahashi suction forceps with suction tube, 10 cm

- 30-346-00 gerade / straight
- 30-346-30 30° aufgewinkelt / 30° angled

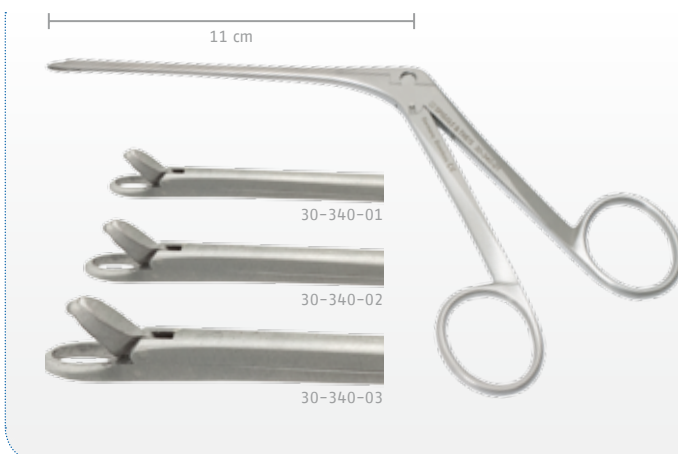

Blakesley Nasenzange, durchschneidend, gerade, 11 cm
Blakesley nasal forceps, throughcutting, straight, 11 cm

- 30-340-01 3,0 x 2,0 mm
- 30-340-02 3,5 x 2,5 mm
- 30-340-03 4,0 x 3,0 mm

FESS-Instruments

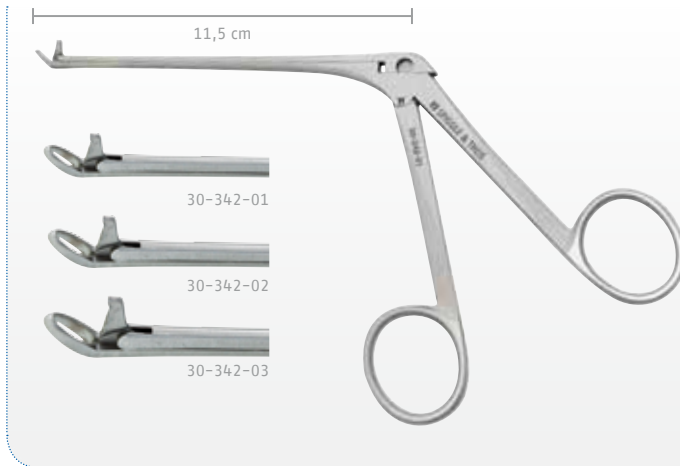

**Blakesley Nasenzange,
durchschneidend, 45° aufgebogen, 11,5 cm**
Blakesley nasal forceps,
throughcutting, 45° curved upwards, 11.5 cm

30-342-01 3,0 x 2,0 mm
30-342-02 3,5 x 2,5 mm
30-342-03 8,0 x 3,0 mm

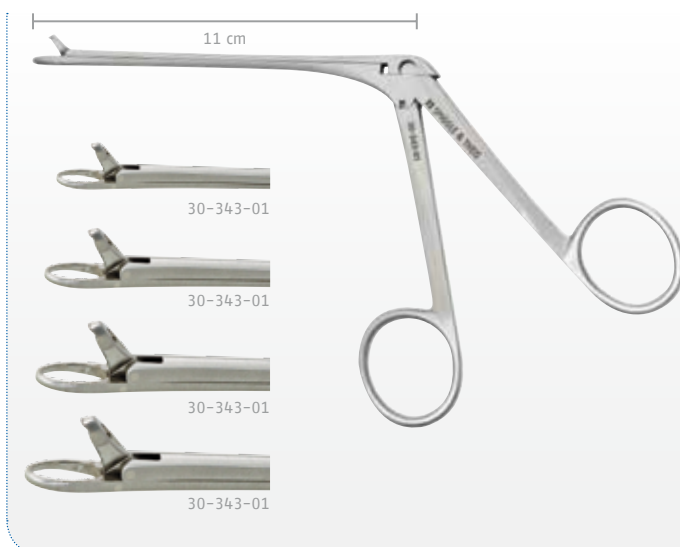

**Blakesley Nasenzange,
durchschneidend, gerade, 11 cm**
Blakesley nasal forceps,
throughcutting, straight, 11 cm

30-343-01 6,0 x 2,5 mm, Größe 1 / Size 1
30-343-02 8,0 x 3,5 mm, Größe 2 / Size 2
30-343-03 9,0 x 4,2 mm, Größe 3 / Size 3
30-343-04 10,0 x 4,8 mm, Größe 4 / Size 4

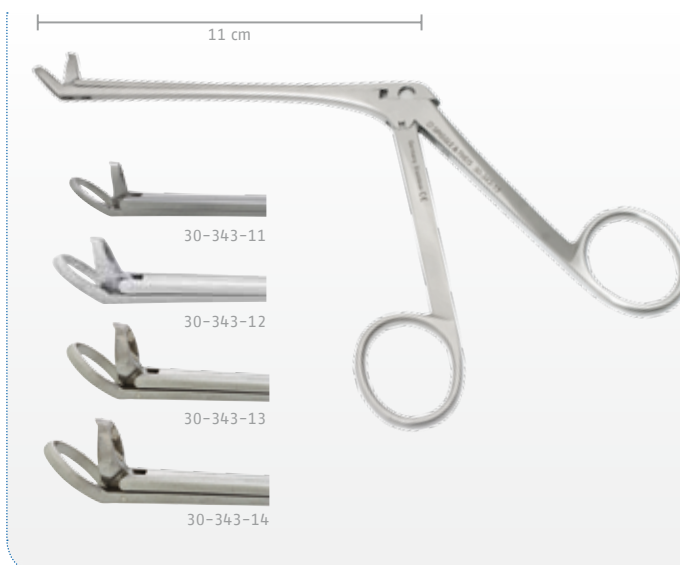

**Blakesley Nasenzange,
durchschneidend, 45° aufgebogen, 11 cm**
Blakesley nasal forceps,
throughcutting, 45° curved upwards, 11 cm

30-343-11 6,0 x 2,5 mm, Größe 1 / Size 1
30-343-12 8,0 x 3,5 mm, Größe 2 / Size 2
30-343-13 9,0 x 4,2 mm, Größe 3 / Size 3
30-343-14 10,0 x 4,8 mm, Größe 4 / Size 4



**Blakesley Nasenzange,
mit Spülkanal, 13 cm**
Blakesley nasal forceps,
with irrigation channel, 13 cm

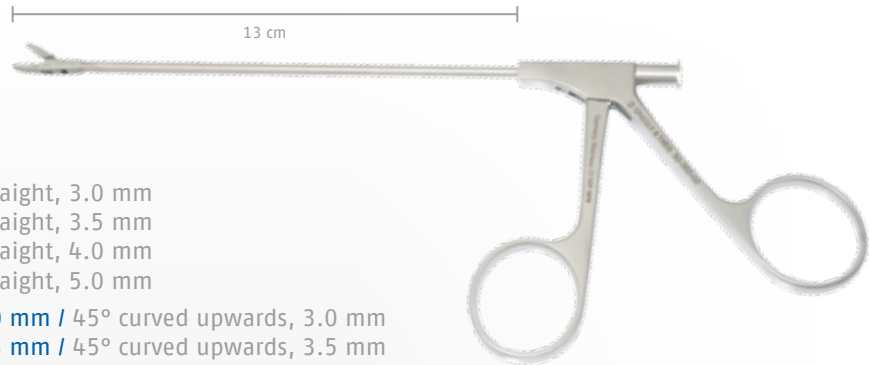

- 30-350-00 gerade, 3,0 mm / straight, 3.0 mm
- 30-350-01 gerade, 3,5 mm / straight, 3.5 mm
- 30-350-02 gerade, 4,0 mm / straight, 4.0 mm
- 30-350-03 gerade, 5,0 mm / straight, 5.0 mm
- 30-352-00 45° aufgebogen, 3,0 mm / 45° curved upwards, 3.0 mm
- 30-352-01 45° aufgebogen, 3,5 mm / 45° curved upwards, 3.5 mm
- 30-352-02 45° aufgebogen, 4,0 mm / 45° curved upwards, 4.0 mm
- 30-354-01 90° aufgebogen, 3,5 mm / 90° curved upwards, 3.5 mm
- 30-354-02 90° aufgebogen, 4,0 mm / 90° curved upwards, 4.0 mm
- 30-358-00 gerade, 3,0 mm, durchschneidend / straight, 3.0 mm, throughcutting
- 30-358-01 gerade, 3,5 mm, durchschneidend / straight, 3.5 mm, throughcutting
- 30-358-02 gerade, 4,0 mm, durchschneidend / straight, 4.0 mm, throughcutting
- 30-360-00 45° aufgebogen, 3,0 mm, durchschneidend / 45° curved upwards, 3.0 mm, throughcutting
- 30-360-01 45° aufgebogen, 3,5 mm, durchschneidend / 45° curved upwards, 3.5 mm, throughcutting
- 30-360-02 45° aufgebogen, 4,0 mm, durchschneidend / 45° curved upwards, 4.0 mm, throughcutting

**Grünwald Rohrschaftzange,
durchschneidend, 13 cm,
mit Spülkanal**
Grünwald tubular forceps,
throughcutting, 13 cm,
with irrigation channel



- 30-370-15 gerade, Schaft gerade, 1,5 mm / straight, straight shaft, 1.5 mm
- 30-370-20 gerade, Schaft gerade, 2,0 mm / straight, straight shaft, 2.0 mm
- 30-370-25 gerade, Schaft gerade, 2,5 mm / straight, straight shaft, 2.5 mm
- 30-370-30 gerade, Schaft gerade, 3,0 mm / straight, straight shaft, 3.0 mm
- 30-371-15 45°, Schaft gerade, 1,5 mm / 45°, straight shaft, 1.5 mm
- 30-371-20 45°, Schaft gerade, 2,0 mm / 45°, straight shaft, 2.0 mm
- 30-371-25 45°, Schaft gerade, 2,5 mm / 45°, straight shaft, 2.5 mm
- 30-371-30 45°, Schaft gerade, 3,0 mm / 45°, straight shaft, 3.0 mm
- 30-372-15 gerade, Schaft 30° aufgebogen, 1,5 mm / straight, shaft 30° curved upwards, 1.5 mm
- 30-372-20 gerade, Schaft 30° aufgebogen, 2,0 mm / straight, shaft 30° curved upwards, 2.0 mm
- 30-372-25 gerade, Schaft 30° aufgebogen, 2,5 mm / straight, shaft 30° curved upwards, 2.5 mm
- 30-373-15 45°, Schaft 30° aufgebogen, 1,5 mm / 45°, shaft 30° upcurved, 1.5 mm
- 30-373-20 45°, Schaft 30° aufgebogen, 2,0 mm / 45°, shaft 30° curved upwards, 2.0 mm
- 30-373-25 45°, Schaft 30° aufgebogen, 2,5 mm / 45°, shaft 30° curved upwards, 2.5 mm
- 30-374-20 gerade öffnend, Schaft 70° aufgebogen, 2,0 mm / straight opening, shaft 70° curved upwards, 2.0 mm
- 30-375-20 seitl. rechts öffnend, Schaft 70° aufgebogen, 2,0 mm / right side opening, shaft 70° curved upwards, 2.0 mm
- 30-376-20 seitl. links öffnend, Schaft 70° aufgebogen, 2,0 mm / left side opening, shaft 70° curved upwards, 2.0 mm

Frontal and Sphenoidal Instruments

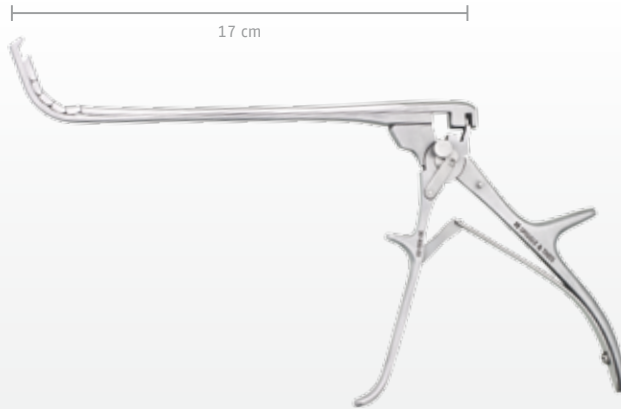

**Stirnhöhlenstanze,
70° aufgebogen, 17 cm**
Frontal sinus punch,
70° curved upwards, 17 cm

30-400-00 3 mm
30-400-01 2 mm



**Rundkopfstanze für Stirnhöhle,
mit Spülkanal, 16 cm**
Frontal sinus circular punch,
with irrigation channel, 16 cm

30-421-35 65°, 3,5 mm
30-421-45 65°, 4,5 mm



**Rundkopfstanze für Stirnhöhle,
eiförmig, 90° Schnitt, mit Spülkanal, 16 cm**
Frontal sinus circular punch, egg-form,
90° cutting, with irrigation channel, 16 cm

30-428-35 60°, 3,5 mm
30-428-45 60°, 4,5 mm



- Rückwärts schneidend / Backwards cutting
- Wenig Kraftaufwand / Little effort required
- Besonders leichtgängig / Runs smoothly
- Perfekte Reinigung / Perfect cleaning

**Stirnhöhlen-Stanze,
aufgebogen, stumpfes Ende, mit Spülkanal,
12,5 cm**
Frontal sinus punch,
curved upwards, blunt end, with irrigation
channel, 12.5 cm

30-425-35 3,5 mm
30-425-45 4,5 mm



Frontal and Sphenoidal Instruments

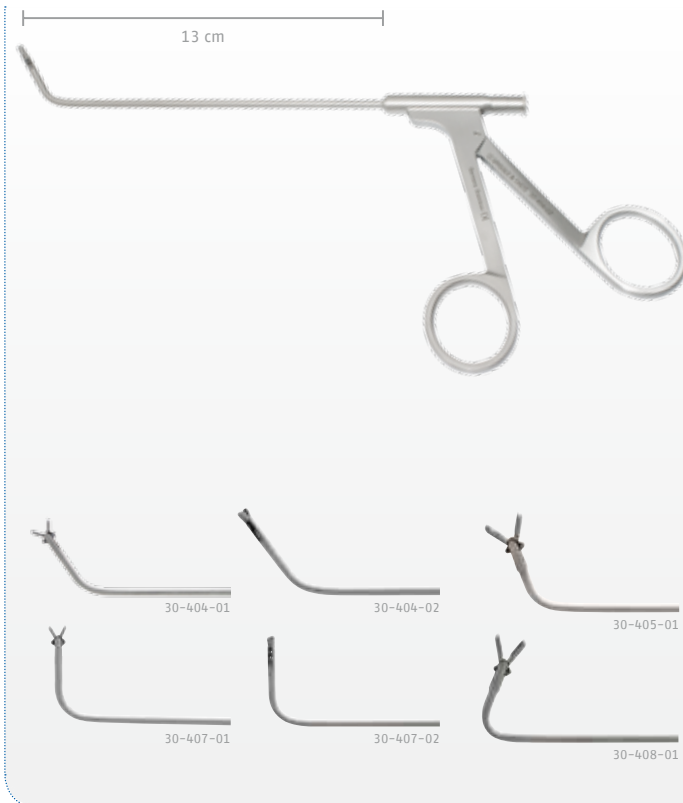

**Stirnhöhlen Löffelzange,
oval, mit Spülkanal, 13 cm**
Frontal sinus forceps,
oval cups, with irrigation channel, 13 cm

- 30-404-01 55°, 2 mm, vertikal / vertical
- 30-404-02 55°, 2 mm, horizontal
- 30-405-01 70°, 4 mm, vertikal / vertical
- 30-405-02 70°, 4 mm, horizontal
- 30-405-11 55°, 4 mm, vertikal / vertical
- 30-405-12 55°, 4 mm, horizontal
- 30-407-01 90°, 2 mm, vertikal / vertical
- 30-407-02 90°, 2 mm, horizontal
- 30-408-01 110°, 4 mm, vertikal / vertical
- 30-408-02 110°, 4 mm, horizontal

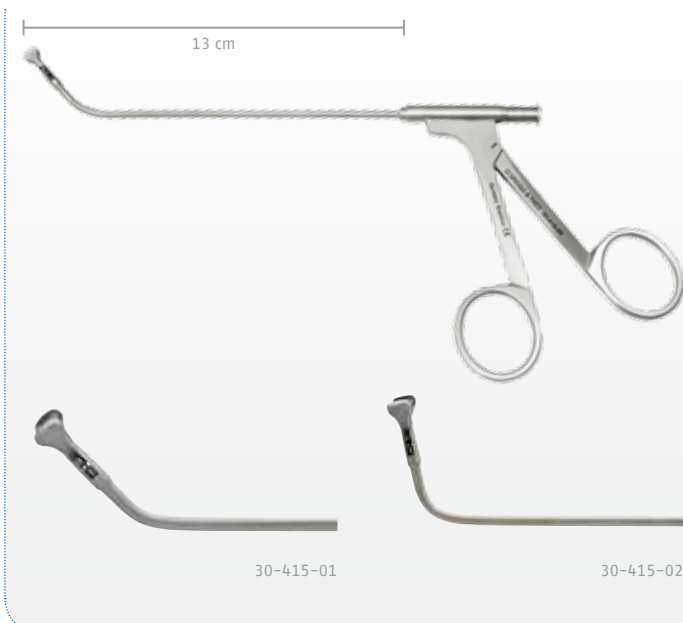

**Binner Polypenfasszange,
3 mm, mit Spülkanal, 13 cm**
Binner polyp forceps,
3 mm, with irrigation channel, 13 cm

- 30-415-01 45°, horizontal
- 30-415-02 80°, horizontal



Frontal and Sphenoidal Instruments

13 / 13,5 cm

**Stirnhöhlenzange,
durchschneidend, 2 mm, mit Spülkanal**
Frontal sinus forceps,
throughcutting, 2 mm, with irrigation channel

30-401-01	55°, 13 cm, vertikal / vertical
30-401-02	55°, 13,5 cm, horizontal
30-402-01	90°, 13 cm, vertikal / vertical
30-402-02	90°, 13 cm, horizontal

13 cm

**Stirnhöhlen Biopsiezange,
3 mm, mit Spülkanal, 13 cm**
Frontal sinus biopsy forceps,
3 mm, with irrigation channel, 13 cm

30-410-01	70°, vertikal / vertical
30-410-02	70°, horizontal
30-411-01	110°, vertikal / vertical
30-411-02	110°, horizontal





Frontal and Sphenoidal Instruments

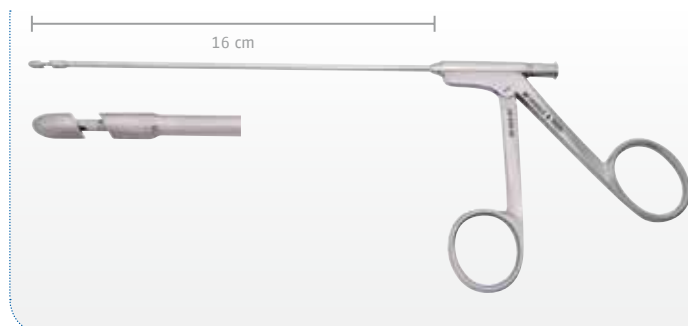

Rundkopfstanze für Keilbeinhöhle, eiförmig, 60° Schnitt, mit Spülkanal, 16 cm
 Sphenoid sinus circular punch, egg-formed, 60° cutting, with irrigation channel, 16 cm

30-429-35 3,5 mm, gerade / straight
 30-429-45 4,5 mm, gerade / straight

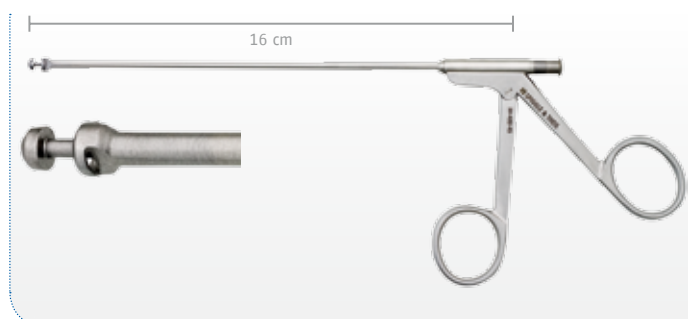

Rundkopfstanze für Keilbeinhöhle, mit Spülkanal, 16 cm
 Sphenoid sinus circular punch, with irrigation channel, 16 cm

30-422-35 0°, 3,5 mm
 30-422-45 0°, 4,5 mm

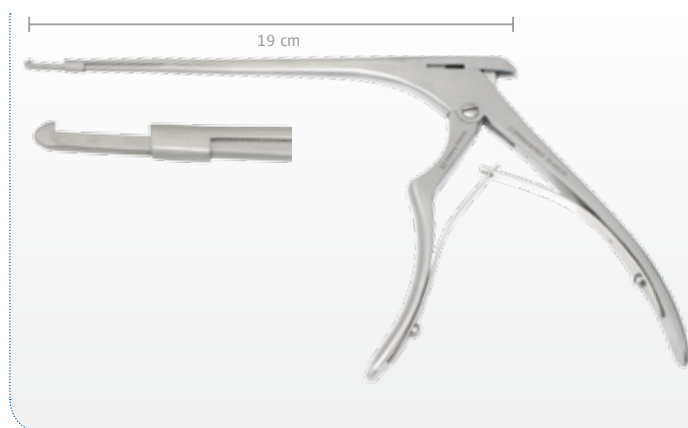

Knochenstanze mit Reservoir, 2 mm, mit Mandrin, 19 cm
 Antrum punch with collector, 2 mm, with stylet, 19 cm

30-450-20



Mandrin zum Entfernen von Knochenmaterial aus Knochenstanzen
 Stylet for removal of bone residue from antrum punch

30-450-90



Frontal and Sphenoidal Instruments

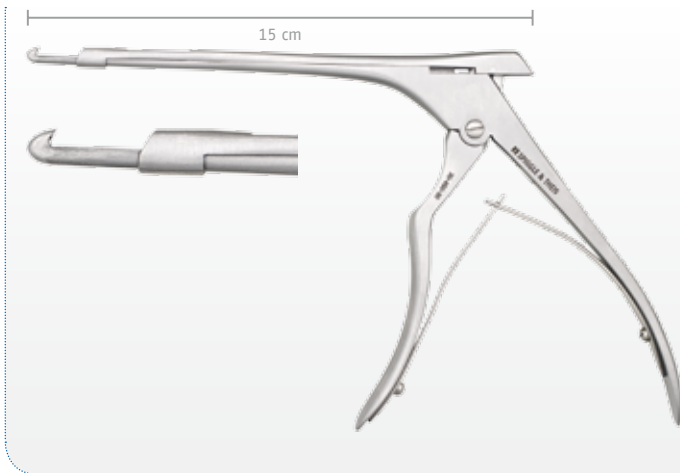

**Knochenstanze mit Reservoir,
3 mm, mit Mandrin, 15 cm**
Antrum punch with collector,
3 mm, with stylet, 15 cm

30-450-30

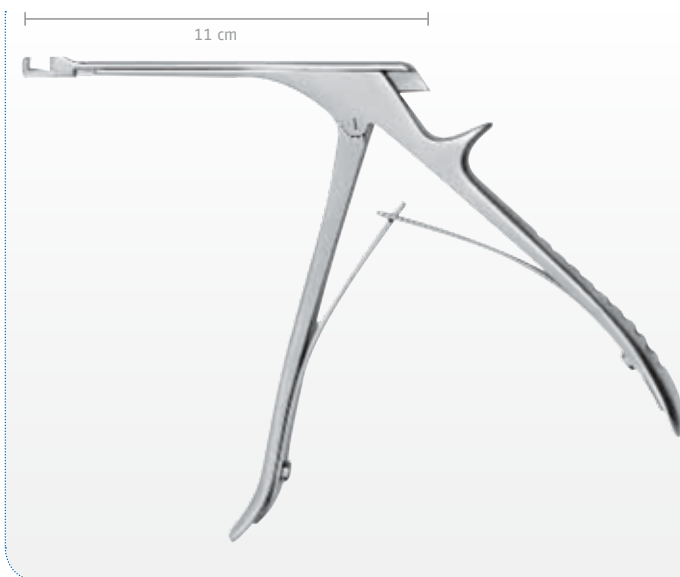

**Beyer Knochenstanze für Kinder,
90°, 1,5 mm, 11 cm**
Beyer antrum punch for children,
90°, 1.5 mm, 11 cm

30-457-15





Frontal and Sphenoidal Instruments



Schwager Stanze für den Orbitaboden, 9,5 cm
Schwager punch for orbita floor, 9.5 cm

- 30-475-01 links / left
- 30-475-02 rechts / right

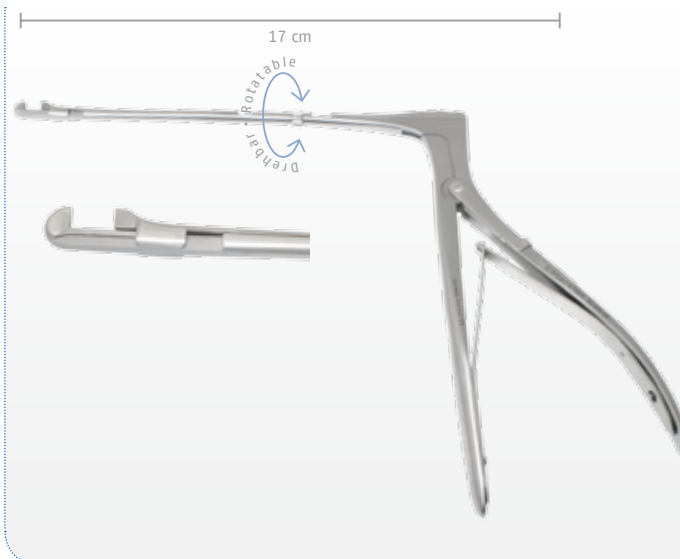

Hajek-Kofler Keilbeinstanze, aufeinander schneidend, drehbar, 3,2 mm, 17 cm, zerlegbar
Hajek-Kofler sphenoid punch, rotatable, 3.2 mm, 17 cm, detachable

30-456-32

Frontal and Sphenoidal Instruments

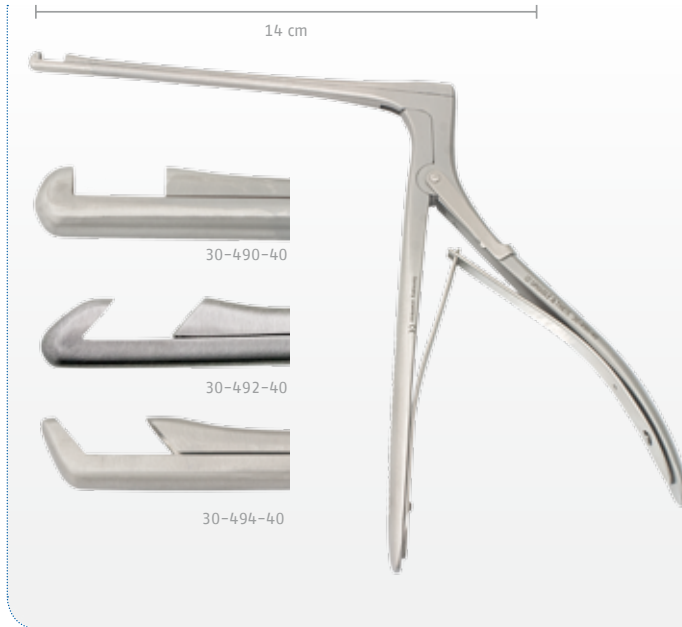

Hajek-Kofler Keilbeinstanze, aufeinander schneidend, zerlegbar 4 mm, 14 cm

Hajek-Kofler sphenoid punch, detachable, 4 mm, 14 cm

- 30-490-40 90°, aufwärts / upwards
- 30-491-40 90°, abwärts / downwards
- 30-492-40 45°, aufwärts, rückwärts / upwards, backwards
- 30-493-40 45°, abwärts, rückwärts / downwards, backwards
- 30-494-40 45°, aufwärts, vorwärts / upwards, forwards

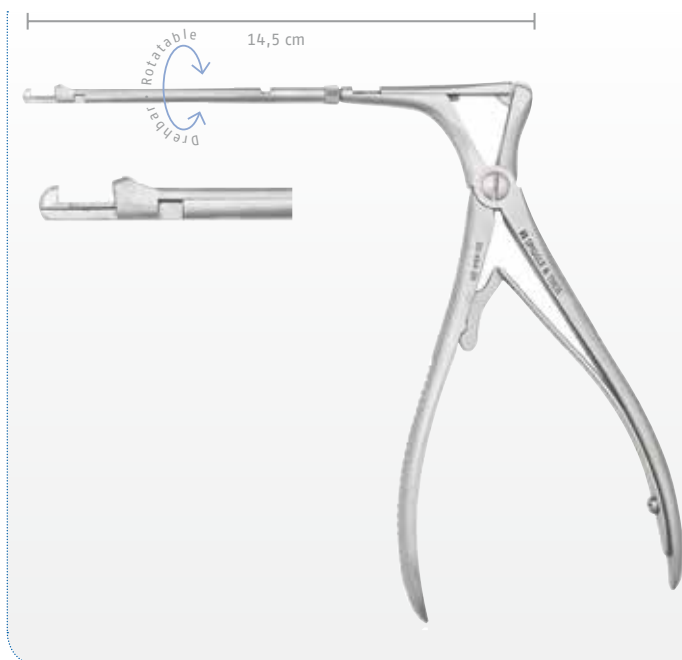

McKenty Keilbeinstanze, durchschneidend, drehbar, 2 mm, 14,5 cm

McKenty sphenoid punch, throughcutting, rotatable, 2 mm, 14.5 cm

30-454-20



Frontal and Sphenoidal Instruments



Kerrison Keilbeinstanze
Kerrison sphenoid punch

- **Komplett zerlegbar**
- **Perfekte Reinigung**
- **Geringer Kraftaufwand**
- **Leichtgängig und präzise**
- **Optimale Ergonomie**
- **Schuh vergoldet**

- **Totally detachable**
- **Perfect cleaning**
- **Little effort required**
- **Smooth running and precise**
- **Optimal ergonomics**
- **Golden tip**

30-468-10	1 mm, 18 cm, 90° aufwärts / upwards
30-468-20	2 mm, 18 cm, 90° aufwärts / upwards
30-468-30	3 mm, 18 cm, 90° aufwärts / upwards
30-468-40	4 mm, 18 cm, 90° aufwärts / upwards
30-468-50	5 mm, 18 cm, 90° aufwärts / upwards
30-469-10	1 mm, 18 cm, 45° aufwärts / upwards
30-469-20	2 mm, 18 cm, 45° aufwärts / upwards
30-469-30	3 mm, 18 cm, 45° aufwärts / upwards
30-469-40	4 mm, 18 cm, 45° aufwärts / upwards
30-469-50	5 mm, 18 cm, 45° aufwärts / upwards
30-471-10	1 mm, 18 cm, 90° abwärts / downwards
30-471-20	2 mm, 18 cm, 90° abwärts / downwards
30-471-30	3 mm, 18 cm, 90° abwärts / downwards
30-473-10	1 mm, 18 cm, 40° abwärts / downwards
30-473-20	2 mm, 18 cm, 40° abwärts / downwards
30-473-30	3 mm, 18 cm, 40° abwärts / downwards
30-477-20	2 mm, 23 cm, 40° aufwärts / upwards
30-477-40	4 mm, 23 cm, 40° aufwärts / upwards



Flexibler Spannarm
zur Verwendung mit selbsthaltenden
NNH-Spekula, mit Verlängerungsstange
Flexible holding arm
for use with self retaining nasal specula,
inclusive holding rods

30-700-00



Gelenkkloben zur Befestigung am OP-Tisch,
passend für 30-700-00 und 40-337-00
Rotation clamp for fixation to operating table,
for 30-700-00 and 40-337-00

30-700-01



NNH-Spekulum für Kinder,
linkes Blatt 25 mm, 13,5 cm
Sinus speculum for children,
left blade 25 mm, 13.5 cm

30-702-25



NNH-Spekulum für Kinder,
rechtes Blatt 25 mm, 13,5 cm
Sinus speculum for children,
right blade 25 mm, 13.5 cm

30-703-25



NNH-Spekulum für Erwachsene, 15 cm
Sinus speculum for adults, 15 cm

30-705-55 55 mm linkes Blatt / left blade
30-705-65 65 mm linkes Blatt / left blade
30-705-75 75 mm linkes Blatt / left blade
30-706-55 55 mm rechtes Blatt / right blade
30-706-65 65 mm rechtes Blatt / right blade
30-706-75 75 mm rechtes Blatt / right blade



Draf Siebbeinzängchen

Draf ethmoid forceps

- 30-720-10 4 x 1,8 mm, 10 cm, gerade / straight
- 30-720-13 4 x 1,8 mm, 13 cm, gerade / straight
- 30-720-16 7 x 2,4 mm, 16 cm, gerade / straight
- 30-720-19 7 x 2,4 mm, 19 cm, gerade / straight
- 30-722-13 6,5 x 2,4 mm, 13 cm, 60° aufgebogen / angled
- 30-722-16 6,5 x 2,4 mm, 16 cm, 60° aufgebogen / angled
- 30-722-19 4 x 1,8 mm, 19 cm, 45° aufgebogen / angled
- 30-724-13 4 x 1,8 mm, 13 cm, 90° aufgebogen / angled
- 30-724-16 4 x 1,8 mm, 16 cm, 90° aufgebogen / angled
- 30-724-19 4 x 1,8 mm, 19 cm, 90° aufgebogen / angled
- 30-726-13 3 x 1,5 mm, 13 cm, gerade / straight
- 30-726-16 3 x 1,5 mm, 16 cm, gerade / straight



Draf Siebbeinzängchen, gerade, fein gerieft, 16 cm

Draf ethmoid forceps, straight, finely serrated, 16 cm

30-728-16

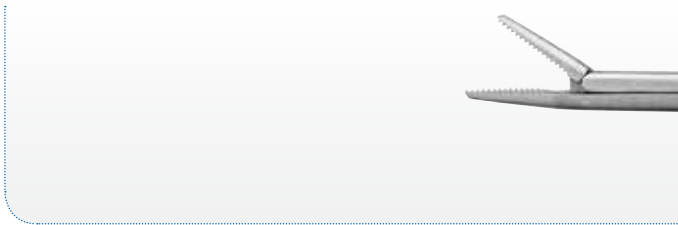

Draf Siebbeinzängchen, gerade, grob gerieft, 16 cm

Draf ethmoid forceps, straight, coarsely serrated, 16 cm

30-729-16



Draf Siebbeinscherchen

Draf ethmoid scissors

- 30-732-13 13 cm, gerade / straight
- 30-732-16 16 cm, gerade / straight
- 30-732-19 19 cm, gerade / straight
- 30-733-16 16 cm, rechts gebogen / curved right
- 30-734-16 16 cm, links gebogen / curved left
- 30-735-19 19 cm, 45° aufwärts gebogen / 45° curved upwards



Microscopic/Endoscopic Instruments for Pansinus Surgery

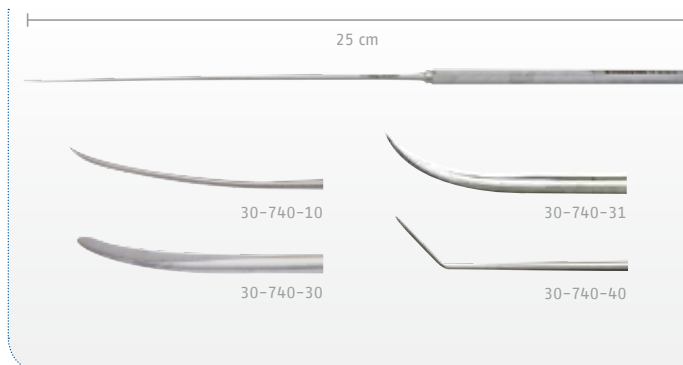

Draf Mikroraspatorium, 25 cm

Draf micro raspatory, 25 cm

30-740-10 1 mm, leicht gebogen / slightly curved

30-740-30 3 mm, leicht gebogen / slightly curved

30-740-31 3 mm, stark gebogen / strongly curved

30-740-40 4 mm, gewinkelt / angled

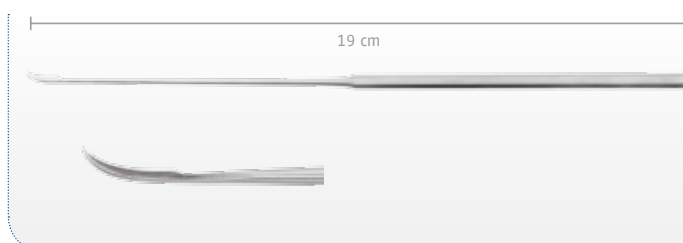

Draf Sichelmesser, 19 cm, gebogen

Draf sickle knife, 19 cm, curved

30-742-19



Draf Rundschnittmesser, 1,5 mm, 19 cm

Draf round knife, 1.5 mm, 19 cm

30-743-19



Draf Incisionsmesser, 19 cm

Draf flap knife, 19 cm

30-744-19

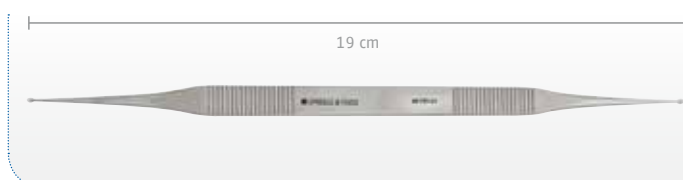

House Löffel, 19 cm

House curette, 19 cm

30-757-21 1,5 x 2,2 mm & 1,8 x 2,5 mm



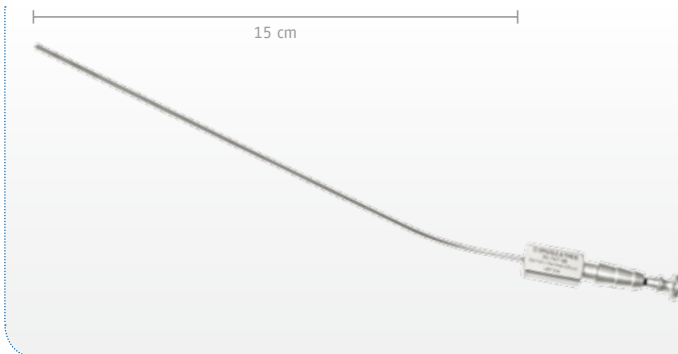

Frazier Saugrohr, 15 cm
Frazier suction tube, 15 cm

- 30-747-06 6 Ch/Fr (2,0 mm)
- 30-747-07 7 Ch/Fr (2,3 mm)
- 30-747-08 8 Ch/Fr (2,7 mm)
- 30-747-09 9 Ch/Fr (3,0 mm)
- 30-747-10 10 Ch/Fr (3,3 mm)
- 30-747-12 12 Ch/Fr (4,0 mm)
- 30-747-15 15 Ch/Fr (5,0 mm)



Saug- und Spülrohr, 16,5 cm
Suction/irrigation tube, 16.5 cm

- 30-749-15 2,5 & 2,0 mm



Federhaken nach Yasargil, 30 cm
Yasargil feather hook, 30 cm

- 30-755-00 klein / small
- 30-755-01 groß / large

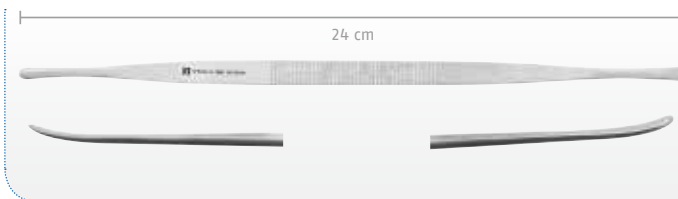

Tönnis Gefäßraspatorium, 24 cm
Tönnis raspatory, 24 cm

- 30-759-21 3 mm & 4 mm

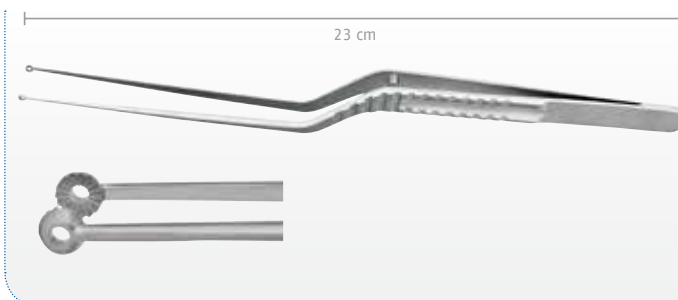

Yasargil Pinzette, ringförmig, 23 cm
Yasargil dressing forceps, ring ended, 23 cm

- 30-770-30 3 mm
- 30-770-50 5 mm



Bipolare Koagulationspinzette, NON-STICK, bajonett, Führungsstift 22,5 cm
Bipolar coagulation forceps, NON-STICK, bayonet, guide pin, 22.5 cm

Spitze / Tip

80-125-03	0,3 mm
80-125-07	0,7 mm
80-125-12	1,2 mm



Bipolares Anschlusskabel, 4 m
Bipolar cable, 4 m

80-016-45	EMC/Dolley
80-017-45	Sutter/Martin/Berchtold/Aesculap/Wolf
80-018-45	Erbe/Storz
80-019-45	Valleylab/Lamidey/Coa/Söring/Olympus/Bowa/Vio



Fisch Wundsperrer mit Gelenken, 17 cm
Fisch retractor, jointed, 17 cm

10-468-17 3:3 Zähne, halbscharf /
3:3 prongs, semi-sharp

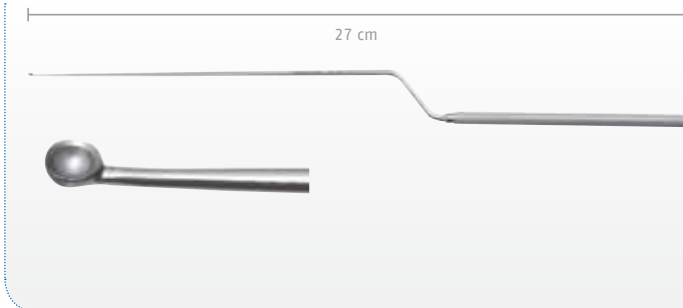

Löffelkürette,
halbscharf, bajonett, gerade,
nach oben, 2 mm, 27 cm
 Spoon curette,
 semi-sharp, bayonet, straight,
 upwards, 2 mm, 27 cm

90-201-01

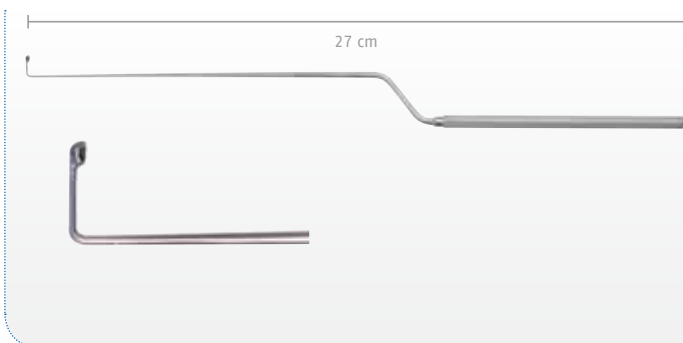

Löffelkürette,
halbscharf, bajonett, 90° nach oben gebogen,
mit 5 mm Steg, 27 cm
 Spoon curette,
 semi-sharp, bayonet, 90° curved upwards,
 with 5 mm bar, 27 cm

90-201-02 2 mm
 90-201-03 3 mm

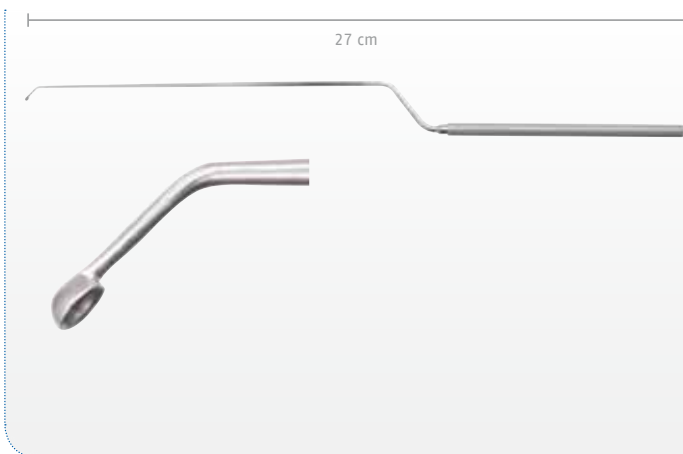

Löffelkürette,
halbscharf, bajonett, mit 5 mm Steg, 27 cm
 Spoon curette,
 semi-sharp, bayonet, with 5 mm bar, 27 cm

90-201-04 45° nach unten gebogen, 2 mm /
 45° curved downwards, 2 mm
 90-201-05 45° nach oben gebogen, 2 mm /
 45° curved upwards, 2 mm
 90-201-06 45° nach unten gebogen, 4 mm /
 45° curved downwards, 4 mm
 90-201-07 45° nach oben gebogen, 4 mm /
 45° curved upwards, 4 mm

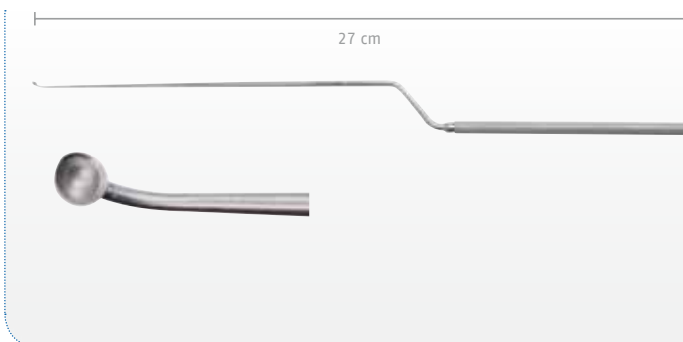

Löffelkürette,
halbscharf, bajonett, 45° leicht nach oben
gebogen, mit 5 mm Steg, 27 cm
 Spoon curette,
 semi-sharp, bayonet, 45° slightly curved
 upwards, with 5 mm bar, 27 cm

90-201-08 2 mm
 90-201-09 4 mm

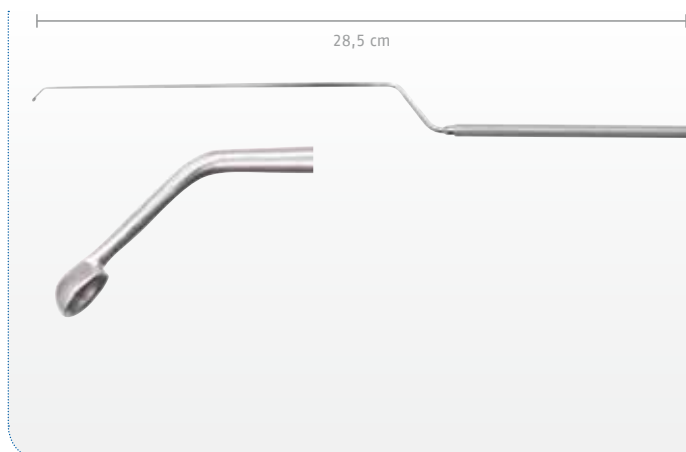

Löffelkürette,
halbscharf, bajonett, mit 5 mm Steg, 28,5 cm
Spoon curette,
semi-sharp, bayonet, with 5 mm bar, 28.5 cm

- 90-201-14 45° nach unten gebogen, 2 mm /
45° curved downwards, 2 mm
- 90-201-15 45° nach oben gebogen, 2 mm /
45° curved upwards, 2 mm
- 90-201-16 45° nach unten gebogen, 4 mm /
45° curved downwards, 4 mm
- 90-201-17 45° nach oben gebogen, 4 mm /
45° curved upwards, 4 mm

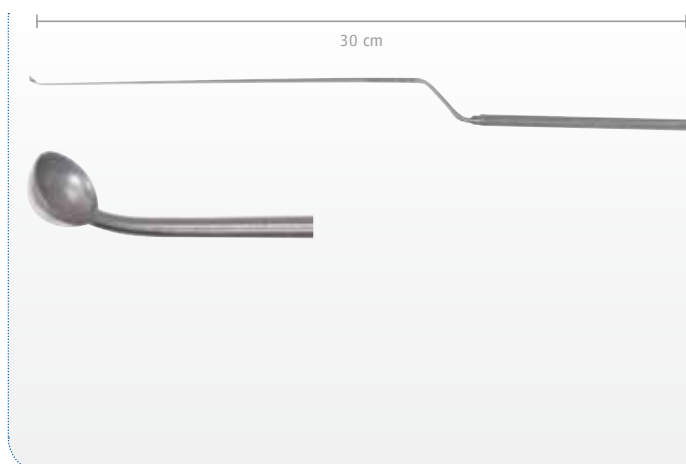

Löffelkürette,
halbscharf, bajonett, 30 cm
Spoon curette,
semi-sharp, bayonet, 30 cm

- 90-201-18 45° leicht nach oben gebogen, 2 mm /
45° slightly curved upwards, 2 mm
- 90-201-19 45° leicht nach oben gebogen, 4 mm /
45° slightly curved upwards, 4 mm
- 90-201-28 45° leicht nach unten gebogen, 2 mm /
45° slightly curved downwards, 2 mm
- 90-201-29 45° leicht nach unten gebogen, 4 mm /
45° slightly curved downwards, 4 mm

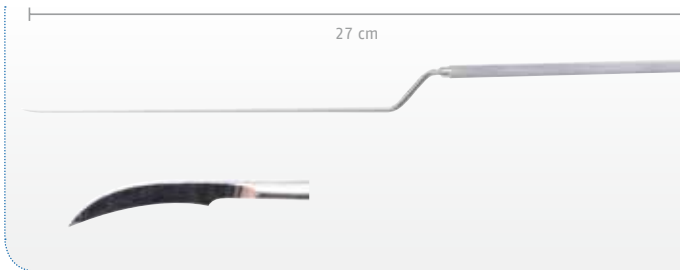

**Sichelmesser spitz,
bajonett, 27 cm**
Sickle knife pointed,
bayonet, 27 cm

- 90-202-01 nach rechts gebogen / curved right
- 90-202-02 nach links gebogen / curved left

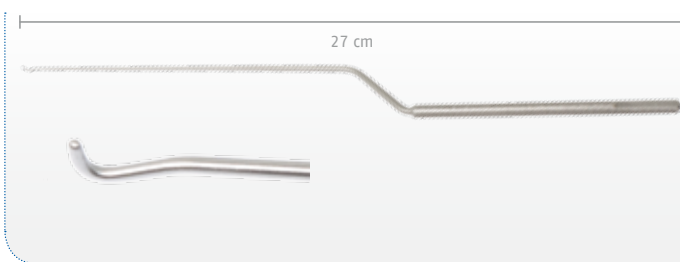

**Enucleator,
Rändelgriff, bajonett, 27 cm**
Enucleator,
knurled handle, bayonet, 27 cm

- 90-204-01 nach links gebogen / curved left
- 90-204-02 nach rechts gebogen / curved right

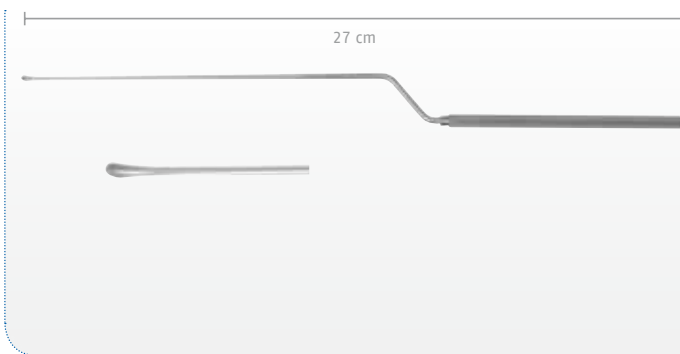

**Raspatorium,
scharf, bajonett, 27 cm**
Raspatory,
sharp, bayonet, 27 cm

- 90-206-01 nach links gebogen / curved left
- 90-206-02 nach rechts gebogen / curved right
- 90-206-03 nach unten gebogen /
curved downwards
- 90-206-04 nach oben gebogen / curved upwards

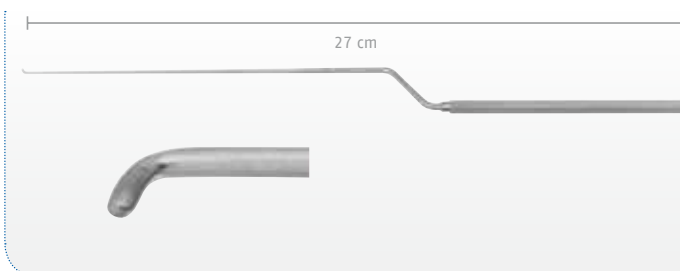

**Sondenhäkchen,
stumpf, bajonett, 27 cm**
Probe hook,
blunt, bayonet, 27 cm

- 90-208-01 nach links gebogen / curved left
- 90-208-02 nach rechts gebogen / curved right



Microscopic/Endoscopic Instruments for Pansinus Surgery

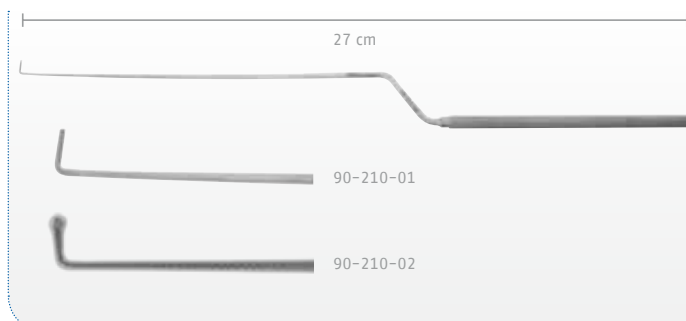

Haken,
nach oben gebogen, 90°, bajonett, 27 cm
Hook,
curved upwards, 90°, bayonet, 27 cm

- 90-210-01 stumpf / blunt
- 90-210-02 mit Sondenknopf, 1 mm /
with ball end, 1 mm

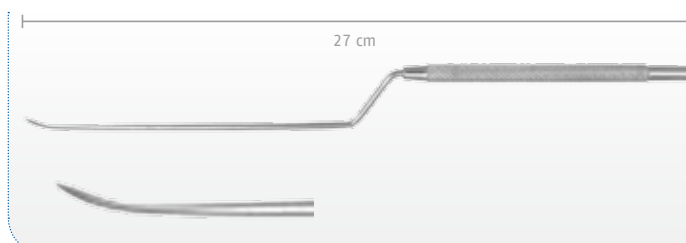

Dissektor,
stumpf, nach oben gebogen, 3 mm, bajonett, 27 cm
Dissector,
blunt, curved upwards, 3 mm, bayonet, 27 cm

90-210-03

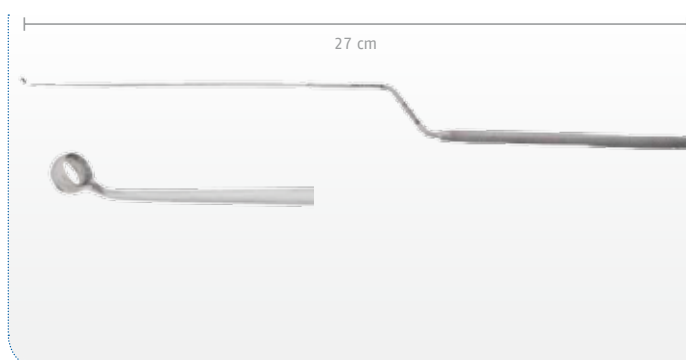

Ringkürette,
scharf, nach oben gebogen, bajonett, 27 cm
Ring curette,
sharp, curved upwards, bayonet, 27 cm

- 90-210-04 45°, 2 mm
- 90-210-05 90°, 2 mm
- 90-210-06 45°, 4 mm
- 90-210-07 90°, 4 mm
- 90-210-08 90°, 5 mm

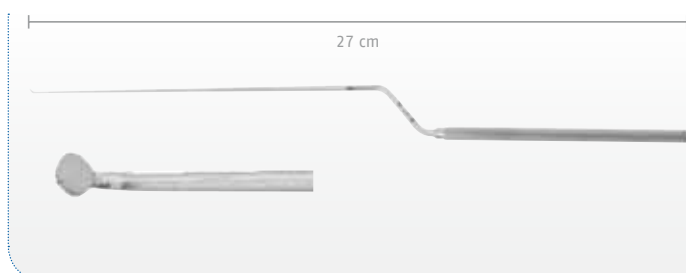

Tellermesser,
nach oben gebogen, 45°, bajonett, 27 cm
Separator,
curved upwards, 45°, bayonet, 27 cm

- 90-210-09 1,5 mm
- 90-210-10 3,5 mm





Löffelkürette,
halbscharf, nach unten gebogen,
2,5 mm, 45°, bajonett, 27 cm
 Spoon curette,
 semi-sharp, curved downwards,
 2.5 mm, 45°, bayonet, 27 cm

90-211-01

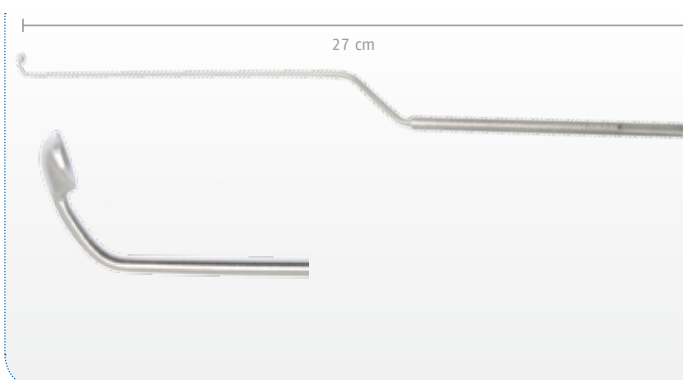

Löffelkürette,
halbscharf, bajonett, 27 cm
 Spoon curette,
 semi-sharp, bayonet, 27 cm

- 90-212-01 leicht nach oben gebogen, 4,5 mm / slightly curved upwards, 4.5 mm
- 90-212-02 stark nach oben gebogen, 4,5 mm / strongly curved upwards, 4.5 mm
- 90-212-03 45° nach oben gebogen, 4,5 mm / 45° curved upwards, 4.5 mm

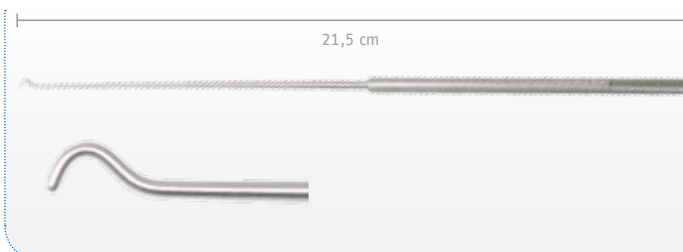

Mikro-Häkchen,
vorwärts/rückwärts, stumpf, gerade, 21,5 cm
 Micro hook,
 forward/backward, blunt, straight, 21.5 cm

90-214-00

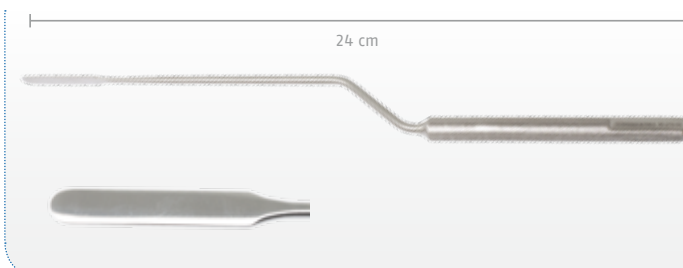

Mukosa Dissektor,
bajonett, 30 x 6 mm, 24 cm
 Mucosa dissector,
 bayonet, 30 x 6 mm, 24 cm

90-215-00

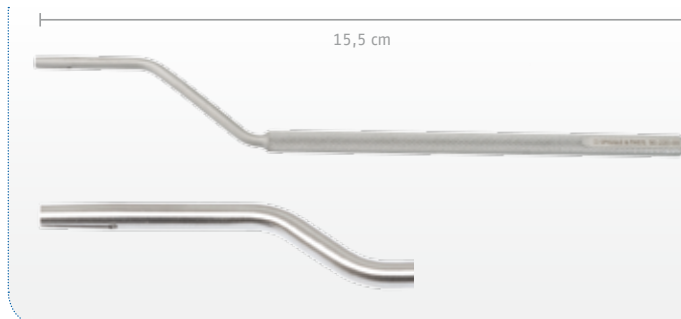

**Spiegel-Griff,
bajonett, rund gerändelt, 15,5 cm**
Mirror handle,
bayonet, knurled, 15.5 cm

90-220-00

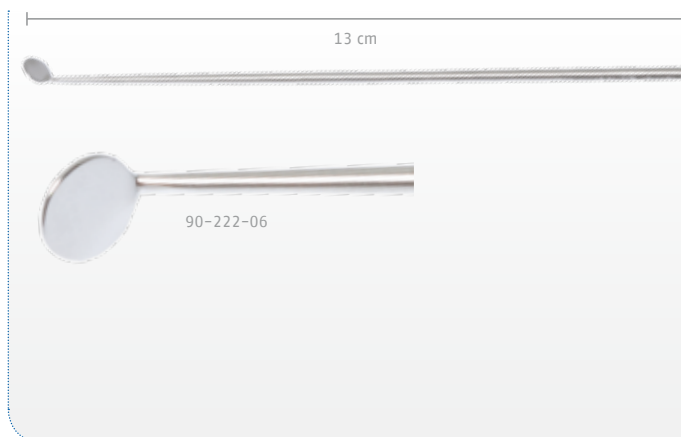

**Spiegel,
rund, hochglanzpoliert, extra fein, 13 cm,
zur Verwendung mit Handgriff 90-220-00**
Mirror,
round, polished, very fine, 13 cm,
for use with handle 90-220-00

- 90-222-04 4 mm
- 90-222-05 5 mm
- 90-222-06 6 mm
- 90-222-08 8 mm
- 90-222-10 10 mm
- 90-222-12 12 mm



Coakley Kieferhöhlenkürette, 17 cm
Coakley antrum curette, 17 cm

- 30-800-01 Fig.1 Vorwärts schneidend / forward cutting
- 30-800-02 Fig.2 Vorwärts schneidend / forward cutting
- 30-800-03 Fig.3 Vorwärts schneidend / forward cutting
- 30-800-04 Fig.4 Rückwärts schneidend / backward cutting
- 30-800-05 Fig.5 Rückwärts schneidend / backward cutting
- 30-800-06 Fig.6 Vorwärts schneidend / forward cutting

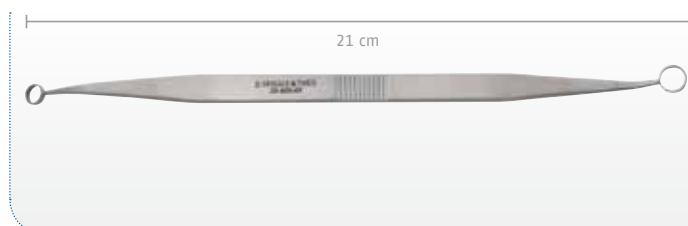

Halle Kieferhöhlenkürette, doppelseitig, 21 cm
Halle antrum curette, double ended, 21 cm

30-805-00



Halle Kieferhöhlenlöffel, biegsam, 21 cm
Halle antrum curette, bendable, 21 cm

- 30-807-01 Gr. 1 / size 1
- 30-807-02 Gr. 2 / size 2
- 30-807-03 Gr. 3 / size 3



Uffenorde Kieferhöhlenlöffel, 21 cm
Uffenorde antrum curette, 21 cm

- 30-809-01 links gebogen / curved left
- 30-809-02 rechts gebogen / curved right



Orbitaschützer, 24 cm
Orbita protector, 24 cm

30-812-24

Miscellaneous



Sewall Kieferhöhlenelevatorium, 19,5 cm
Sewall antrum elevator, 19.5 cm

30-814-19



West Hohlmeißel, 4 mm, 18 cm
West gouge, 4 mm, 18 cm

30-816-40



West Flachmeißel, 4,5 mm, 18 cm
West chisel, 4.5 mm, 18 cm

30-817-40

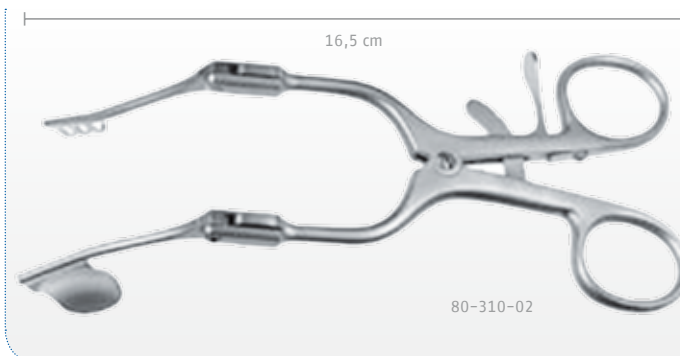

Orbita Gelenksperrer, 16,5 cm
Orbita retractor, 16.5 cm

80-310-01 Blatt rechts / blade right
80-310-02 Blatt links / blade left

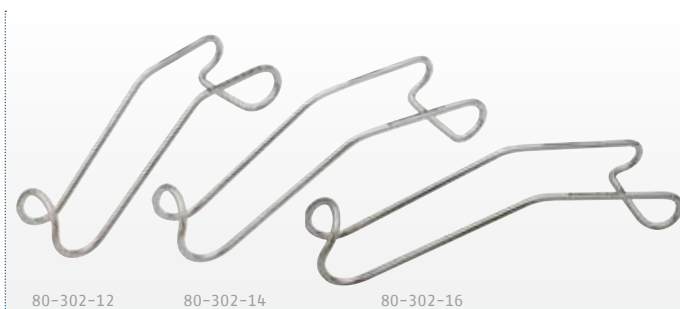

Sternberg Lippenhaken
Sternberg lip retractor

80-302-12 12 cm
80-302-14 14 cm
80-302-16 16 cm



Brünings-Brunk Wundhaken, gezahnt, 22 cm
Brünings-Brunk retractor, with teeth, 22 cm

80-304-00

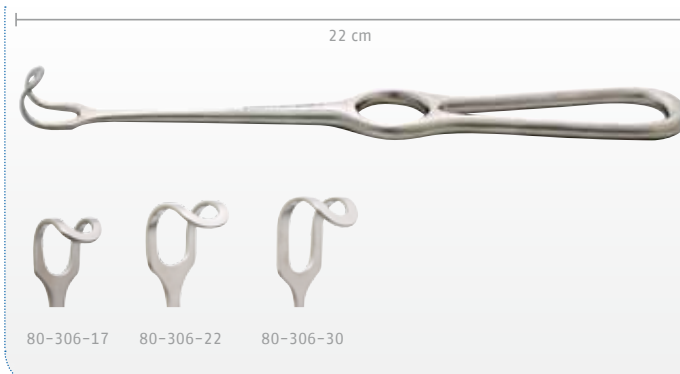

Middeldorpf Wundhaken, 22 cm
Middeldorpf retractor, 22 cm

- 80-306-17 14 x 17 mm
- 80-306-22 20 x 22 mm
- 80-306-30 26 x 30 mm

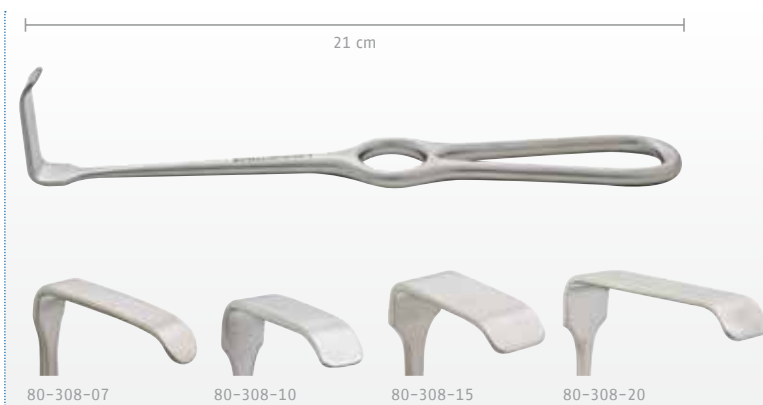

Langenbeck Wundhaken, 21 cm
Langenbeck retractor, 21 cm

- 80-308-07 35 x 7 mm
- 80-308-10 35 x 10 mm
- 80-308-15 35 x 15 mm
- 80-308-20 60 x 20 mm



**Langenbeck-Green Wundhaken,
Flachgriff, 24 x 6 mm, 16 cm**
Langenbeck-Green retractor,
flat handle, 24 x 6 mm, 16 cm

80-334-16



**Spezial-Ölspray,
Pflegespray für Instrumente, Dose 500 ml**
Special oilspray,
maintenance spray for instruments, 500 ml

80-650-00

Miscellaneous



Metallschale
Metal bowl

80-501-01	B1	Ø 40 mm	H=19 mm	20 ml
80-501-02	B2	Ø 60 mm	H=39 mm	60 ml
80-501-03	B3	Ø 85 mm	H=40 mm	160 ml
80-501-04	B4	Ø 110 mm	H=55 mm	400 ml



Medizinbecher, Edelstahl, graduiert
Medicine cup, stainless steel, graduated

80-503-03	Ø 50 mm	H=25 mm	30 ml
80-504-05	Ø 53 mm	H=45 mm	50 ml



Lösungsschale, Edelstahl
Solution bowl, stainless steel

80-506-30	B1	Ø 100 mm	H=65 mm	300 ml
80-507-40	B2	Ø 120 mm	H=70 mm	400 ml
80-509-75	B3	Ø 150 mm	H=75 mm	750 ml



Tablettenschale, Edelstahl, Ø 65 mm, H=20 mm
Tablet dish, stainless steel, Ø 65 mm, H=20 mm

80-512-00



Petrischale, Klarglas, mit Deckel
Petri dish, clear glass, with lid

	AD / OD	Höhe / Height
80-515-06	60 mm	15 mm
80-515-08	80 mm	15 mm
80-515-10	150 mm	20 mm



Medikamenten-Schälchen, Glas, schwarz, mit Deckel, 4 x 4 cm
Medication dish, glass, black, with lid, 4 x 4 cm

80-517-00



80-519-00



80-519-01



80-519-02



80-519-03

**Medikamenten-Schälchen,
Dappenglas, farbig, Ø 3,2 cm**
Medication dish,
dappen-glass, coloured, Ø 3.2 cm

80-519-00 kristall / crystal
80-519-01 grün / green
80-519-02 rosa / pink
80-519-03 topas / topaz



Porzellan-Schälchen, rund, mit Ausguss
China bowl, round, with spout

	Ø
80-520-06	8 cm
80-520-08	10 cm



Nierenschale, Edelstahl
Kidney bowl, stainless steel

80-525-17	17,5 cm
80-525-25	25,0 cm



Kornzangen-Behälter, Edelstahl
Forceps holder, stainless steel

	Ø	Höhe / Height
80-528-13	5,0 cm	13,5 cm
80-528-18	5,0 cm	18,0 cm
80-528-20	9,5 cm	20,0 cm



**Kornzangen-Behälter,
Glas, Edelstahldeckel mit Ausschnitt,
Ø 8 cm, Höhe 20 cm**
Forceps holder,
glass, stainless steel lid with opening,
Ø 8 cm, height 20 cm

80-530-20

Sterilization Systems



**Norm-Sterilisations-Container,
Normal-Boden, Ventil-Deckel mit Thermoloc,
Aluminium, Griff-Farbe nach Wahl**
Norm sterilisation container,
unperforated bottom, valve lid with thermoloc,
aluminium, handle color of your choice

80-630-12	29,6 x 27,5 x 12 cm
80-630-21	29,6 x 27,5 x 21 cm
80-660-14	59,6 x 27,5 x 14 cm
80-660-21	59,6 x 27,5 x 21 cm



**Siebkorb,
Edelstahl-Drahtgeflecht, Fallgriffe**
Basket,
stainless-steel wire mesh, sliding handles

80-670-25	24,5 x 24,5 x 6 cm
80-670-40	40,0 x 24,5 x 6 cm
80-670-49	48,5 x 24,5 x 6 cm



Codier-Schild, 6 x 2 cm, 20 Zeichen
Coding label, 6 x 2 cm, 20 characters

80-680-01	schwarz / black
80-680-02	rot / red
80-680-03	braun / brown
80-680-04	grün / green
80-680-05	gelb / yellow
80-680-06	lila / purple
80-680-07	blau / blue

Zubehör

Accessories

- 80-683-00 Container-Siegel, disposable, blau, 500 Stück/Box**
Container seal, disposable, blue, 500 pieces/box
- 80-684-00 Indikator-Klebe-Etikett, Lasche rechts, 1000 Stück/Box**
Adhesive indicator label, latch right side, 1000 pieces/box
- 80-685-00 Entsorgungsmarke, Edelstahl, zum Aufstecken, 2,5 x 3 cm, inclusive Gravur bis zu 5 Zeichen**
Clip on coding clamp, stainless steel, 2.5 x 3 cm, including engraving up to 5 characters
- 80-688-00 Klemmschild aus Edelstahl, hitzebeständig, 6 x 4 cm, 25 Stück/Box**
Label holder with clip, stainless steel, heat resistant, 6 x 4 cm, 25 pieces/box

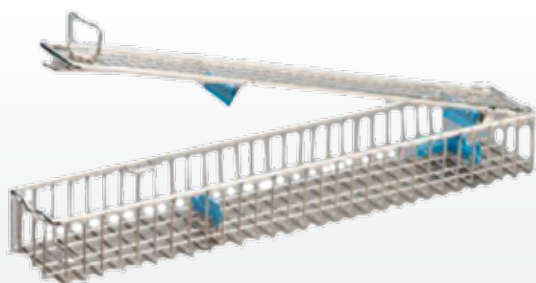

Endoskopie-Siebkorb mit Deckel, Edelstahl, epoliert
Endoscope container with lid, stainless steel, e-polished

80-690-01 29 x 8 x 5,2 cm
für 1 Endoskop / for 1 endoscope

80-690-02 29 x 8 x 5,2 cm
für 2 Endoskope / for 2 endoscopes

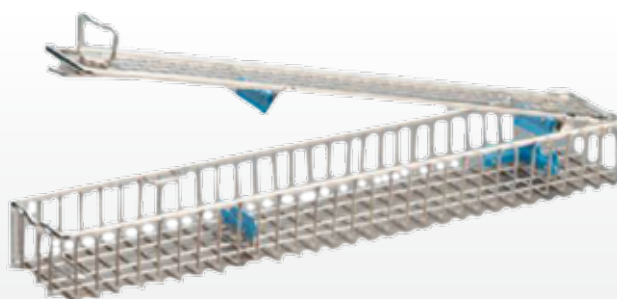

Endoskopie-Siebkorb mit Deckel, Edelstahl, epoliert
Endoscope container with lid, stainless steel, e-polished

80-691-01 46 x 8 x 5,2 cm
für 1 Endoskop / for 1 endoscope

80-692-01 67 x 8 x 5,2 cm
für 1 Endoskop / for 1 endoscope



Sterilisations- und Aufbewahrungssystem "Instru-Safe" für NNH-Set

Sterilisation and protection system "Instru-Safe" for sinus surgery set

80-611-10

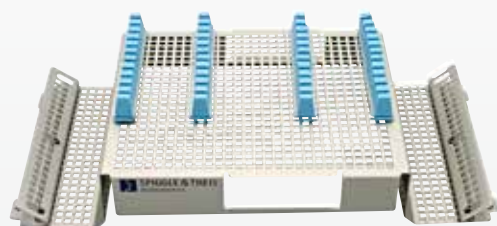

- Instrumentenbox
- Halterung für 20 Nasenzangen
- Leerraum für sperrige Instrumente
- Silikon-Noppen-Matte für feine Instrumente
- 270 x 245 x 152 mm



- Instrument box
- Segments for 20 nasal forceps
- Space for bulky instruments
- Silicone finger mat for delicate instruments
- 270 x 245 x 152 mm

Sets

30-900-00 FESS – Basis-Set
FESS – Basic-Set

Bestehend aus / Consisting of:

- | | | | |
|-----------|--|-----------|---|
| 30-142-00 | Sinuskop, HD, autoklavierbar, 4,0 mm, AL 175 mm, 0°
Sinuscope, HD, autoclavable, 4.0 mm, WL 175 mm, 0° | 20-235-03 | Blakesley Nasenzange, 90° aufgebogen, Gr. 3
Blakesley nasal forceps, 90° curved upwards, size 3 |
| 30-142-45 | Sinuskop, HD, autoklavierbar, 4,0 mm, AL 175 mm, 45°
Sinuscope, HD, autoclavable, 4.0 mm, WL 175 mm, 45° | 20-690-01 | Conchotomie Schere, gerade
Nasal concha scissors, straight |
| 30-142-70 | Sinuskop, HD, autoklavierbar, 4,0 mm, AL 175 mm, 70°
Sinuscope, HD, autoclavable, 4.0 mm, WL 175 mm, 70° | 30-320-01 | Durchschneidende Nasenzange, 5,0 x 1,5 mm, gerade
Throughcutting nasal forceps, 5.0 x 1.5 mm, straight |
| 30-160-02 | Ultra-Stop Antibeschlagmittel, 30 ml, Durchstichflasche, steril
Ultra-Stop antifog solution, 30 ml, pierce bottle, sterile | 30-320-02 | Durchschneidende Nasenzange, 6,0 x 2,5 mm, gerade
Throughcutting nasal forceps, 6.0 x 2.5 mm, straight |
| 20-100-01 | Hartmann Nasenspekulum für Erwachsene
Hartmann nasal speculum for adults | 30-321-01 | Durchschneidende Nasenzange, 60° gewinkelt, 5,0 x 1,5 mm
Throughcutting nasal forceps, 60° angled, 5.0 x 1.5 mm |
| 20-150-75 | Killian-Struycken Septumspekulum, 75 mm
Killian-Struycken nasal speculum, 75 mm | 30-322-02 | Durchschneidende Nasenzange, aufgebogen, 6,5 x 2,5 mm
Throughcutting nasal forceps, curved upwards, 6.5 x 2.5 mm |
| 30-102-30 | Eicken Spülröhrchen, kurze Biegung, ø 3,0 mm
Eicken antrum cannula, short curve, ø 3.0 mm | 30-304-25 | Antrumstanze, rückwärts schneidend, drehbar, 2,5 mm
Antrum punch, backward cutting, rotatable, 2.5 mm |
| 30-122-08 | Injektionskanüle, kniegebogen, 0,8 mm
Injection needle, angled, 0.8 mm | 30-468-20 | Kerrison Keilbeinstanze, zerlegbar, 2 mm, 90° aufwärts
Kerrison sphenoid punch, detachable, 2 mm, 90° upwards |
| 30-104-10 | Frazier Saugrohr, Knopfende, 10 Ch/Fr
Frazier suction tube, ball ended, 10 Ch/Fr | 30-333-02 | Herberhold cranial durchschneidende Zange, 60° aufgebogen, flach, 11,5 x 2,5 mm
Herberhold cranial throughcutting forceps, 60° curved upwards, flat, 11.5 x 2.5 mm |
| 30-104-12 | Frazier Saugrohr, Knopfende, 12 Ch/Fr
Frazier suction tube, ball ended, 12 Ch/Fr | 30-308-01 | Antrumstanze, links schneidend
Antrum punch, left cutting |
| 30-104-15 | Frazier Saugrohr, Knopfende, 15 Ch/Fr
Frazier suction tube, ball ended, 15 Ch/Fr | 30-308-02 | Antrumstanze, rechts schneidend
Antrum punch, right cutting |
| 20-305-18 | Freer Doppellevatorium, scharf/stumpf
Freer elevator, double ended, sharp/blunt | 30-422-45 | Rundkopfstanze für Keilbeinhöhle, 0°, 4,5 mm, mit Spülkanal
Sphenoid sinus circular punch, 0°, 4.5 mm, with irrigation channel |
| 30-155-50 | Antrum Trokar, schnabelförmig, 5 mm AD
Antrum trocar, beaked, 5 mm OD | 30-400-01 | Stirnhöhlenstanze, 70° aufgebogen, 2 mm
Frontal sinus punch, 70° curved upwards, 2 mm |
| 30-200-01 | Sichelmesser, gerader Schaft, spitz
Sickle knife, straight shaft, pointed | 80-660-14 | Norm-Sterilisations-Container, Thermoloc, 596 x 275 x 140 mm
Norm sterilisation container, thermoloc, 596 x 275 x 140 mm |
| 30-205-02 | Antrum-Löffel, längsoval, klein, 2,5 x 6,0 mm, 45°
Antrum curette, oval, small, 2.5 x 6.0 mm, 45° | 80-670-49 | Siebkorb, Edelstahlgeflecht, Fallgriffe, 485 x 245 x 60 mm
Basket, stainless-steel wire mesh, slide handles, 485 x 245 x 60 mm |
| 30-205-06 | Stirnhöhlen-Löffel, gerader Schaft, längsoval, 90° aufgebogen
Frontal sinus curette, straight shaft, oval, 90° upcurved | 80-680-01 | Codier-Schild, 60 x 20 mm, schwarz, 20 Zeichen
Coding label, 60 x 20 mm, black, 20 characters |
| 30-203-01 | Antrum-Kürette, gerader Schaft, vorwärts schneidend
Antrum curette, straight shaft, forward cutting | 30-425-45 | Stirnhöhlen-Stanze, aufgebogen, stumpfes Ende, mit Spülkanal, 4,5 mm
Frontal sinus punch, curved upwards, blunt end, with irrigation channel, 4.5 mm |
| 30-203-02 | Antrum-Kürette, gerader Schaft, rückw. schneidend
Antrum curette, straight shaft, backward cutting | | |
| 30-410-01 | Stirnhöhlen Biopsiezange, 70°, 3 mm, vertikal, mit Spülkanal
Frontal sinus biopsy forceps, 70°, 3 mm, vertical, with irrigation channel | | |
| 30-411-01 | Stirnhöhlen Biopsiezange, 110°, 3 mm, vertikal, mit Spülkanal
Frontal sinus biopsy forceps, 110°, 3 mm, vertical, with irrigation channel | | |
| 30-311-02 | Kieferhöhlen Polypen-Fasszange, rückwärts öffnend, drehbar
Antrum polyp grasping forceps, retrograde opening, rotatable | | |
| 30-207-01 | Stirnhöhlen-Sonde, doppelseitig, leicht gebogen, 19 cm
Frontal sinus seeker, double ended, slightly curved, 19 cm | | |
| 30-207-02 | Kieferhöhlensonde, doppelseitig, 19 cm
Maxillary sinus seeker, double ended, 19 cm | | |
| 30-207-03 | Stirnhöhlensonde, doppelseitig, stark gebogen, 19 cm
Frontal sinus seeker, double ended, strongly curved, 19 cm | | |
| 30-402-02 | Stirnhöhlenzange, durchschneidend, 90°, 2 mm, horizontal
Frontal sinus forceps, throughcutting, 90°, 2 mm, horizontal | | |
| 20-215-01 | Blakesley Nasenzange, gerade, Gr. 1
Blakesley nasal forceps, straight, size 1 | | |
| 20-225-02 | Blakesley Nasenzange, 45° aufgebogen, Gr. 2
Blakesley nasal forceps, 45° curved upwards, size 2 | | |



30-905-00 Pädiatrisches FESS-Set Pediatric FESS-Set

Bestehend aus / Consisting of:

- 20-100-02 **Hartmann Nasenspekulum für Jugendliche**
Hartmann nasal speculum for juveniles
- 30-101-25 **Eicken Spülröhrchen, lange Biegung, 2,5 mm Durchmesser**
Eicken antrum cannula, long curve, 2.5 mm diameter
- 30-102-25 **Eicken Spülröhrchen, kurze Biegung, 2,5 mm Durchmesser**
Eicken antrum cannula, short curve, 2.5 mm diameter
- 30-104-10 **Frazier Saugrohr, Knopfende, 10 Ch (3,3 mm)**
Frazier suction tube, ball ended, 10 Fr (3.3 mm)
- 30-127-00 **Endoskop, 187,5 mm AL, 3,0 mm AD, 0°**
Endoscope, 187.5 mm length, 3.0 mm OD, 0°
- 30-127-30 **Endoskop, 187,5 mm AL, 3,0 mm AD, 30°**
Endoscope, 187.5 mm length, 3.0 mm outer diameter, 30°
- 30-160-02 **Ultra-Stop Antifogmittel, 30 ml, Durchstichflasche steril**
Ultra-Stop antifog solution, 30 ml, pierce bottle, sterile
- 30-742-19 **Draf Sichelmesser, 19 cm, gebogen**
Draf sickle knife, 19 cm, curved
- 20-305-18 **Freer Doppellevatorium, scharf/stumpf**
Freer elevator, double ended, sharp/blunt
- 30-207-01 **Stirnhöhlen-Sonde, doppelseitig, leicht gebogen**
Frontal sinus seeker, double ended, slightly curved
- 30-207-02 **Kieferhöhlen-Sonde, doppelseitig**
Maxillary sinus seeker, double end
- 30-205-02 **Antrum-Löffel, längsoval, klein, 2,5 x 6,0 mm, 45° gewinkelt**
Antrum curette, oval, small, 2.5 x 6.0 mm, 45° angled
- 30-205-06 **Antrum-Löffel, längsoval, klein, 2,5 x 6,0 mm, 90° gewinkelt**
Antrum curette, oval, small, 2.5 x 6.0 mm, 90° angled
- 30-122-08 **Injektionskanüle, kniegebogen, 0,8 mm**
Injection needle, angled, 0.8 mm
- 20-215-00 **Blakesley Nasenzange, gerade, Gr. 0**
Blakesley nasal forceps, straight, size 0
- 20-225-00 **Blakesley Nasenzange, 45° aufgebogen, Gr. 0**
Blakesley nasal forceps, 45° upcurved, size 0
- 30-304-15 **Antrumstanze, rückwärts schneidend, drehbar, 1,5 mm**
Antrum punch, backward cutting, rotatable, 1.5 mm
- 30-330-01 **Wigand durchschneidende Zange, flach, abgerundet, 4,0 x 3,0 mm, gerade, 14 cm**
Wigand throughcutting forceps, flat, rounded, 4.0 x 3.0 mm, straight, 14 cm
- 30-330-02 **Wigand durchschneidende Zange, flach, abgerundet, 4,0 x 3,0 mm, 45° aufgewinkelt, 14 cm**
Wigand throughcutting forceps, flat, rounded, 4.0 x 3.0 mm, 45° angled, 14 cm
- 30-407-02 **Stirnhöhlen Löffelzange, 90°, 2 mm, horizontal, mit Spülkanal**
Frontal sinus forceps, oval cups, 90°, 2 mm, horizontal, with irrigation channel
- 30-720-16 **Draf Siebbeinzängchen, gerade, 4 x 1,8 mm, 16 cm**
Draf ethmoid forceps, straight, 4 x 1.8 mm, 16 cm
- 30-720-16 **Draf Siebbeinzängchen, gerade, 4 x 1,8 mm, 16 cm**
Draf ethmoid forceps, straight, 4 x 1.8 mm, 16 cm
- 80-660-14 **Norm-Sterilisations-Container, Thermoloc, 596 x 275 x 140 mm**
Norm sterilisation container, thermoloc, 596 x 275 x 140 mm
- 80-670-49 **Siebkorb, Edelstahlgeflecht, Fallgriffe, 485 x 245 x 60 mm**
Basket, stainless-steel wire mesh, slide handles, 485 x 245 x 60 mm
- 80-680-01 **Codier-Schild, 60 x 20 mm, schwarz, 20 Zeichen**
Coding label, 60 x 20 mm, black, 20 characters

Sets

30-902-00 Schädelbasis-Set
Skull base-Set

Bestehend aus / Consisting of:

77HW002	Bohrhandstück, gewinkelt, autoklavierbar, 1:1 Drill handpiece, angled, autoclavable, 1:1	30-743-19	Draf Rundschnittmesser, 19 cm, 1,5 mm Draf round knife, 19 cm, 1.5 mm
CR095011206	Osteotomie-Bohrer, HM, 95 mm, 1,2 mm, 6 Schneiden Osteotomy bur, TC, 95 mm, 1.2 mm, 6 blades	30-744-19	Draf Incisionsmesser, 19 cm Draf incision knife, 19 cm
CR095011806	Osteotomie-Bohrer, HM, 95 mm, 1,8 mm, 6 Schneiden Osteotomy bur, TC, 95 mm, 1.8 mm, 6 blades	30-757-21	House Löffel, 19 cm, 1,5 x 2,2 mm & 1,8 x 2,5 mm House curette, 19 cm, 1.5 x 2.2 mm & 1.8 x 2.5 mm
CR095012306	Osteotomie-Bohrer, HM, 95 mm, 2,3 mm, 6 Schneiden Osteotomy bur, TC, 95 mm, 2.3 mm, 6 blades	30-747-06	Frazier Saugrohr, 15 cm, 6 Ch/Fr (2,0 mm) Frazier suction tube, 15 cm, 6 Ch/Fr (2.0 mm)
CR095014008	Osteotomie-Bohrer, HM, 95 mm, 4,0 mm, 8 Schneiden Osteotomy bur, TC, 95 mm, 4.0 mm, 8 blades	30-747-08	Frazier Saugrohr, 15 cm, 8 Ch/Fr (2,7 mm) Frazier suction tube, 15 cm, 8 Ch/Fr (2.7 mm)
CR095016014	Osteotomie-Bohrer, HM, 95 mm, 6,0 mm, 14 Schneiden Osteotomy bur, TC, 95 mm, 6.0 mm, 14 blades	30-747-10	Frazier Saugrohr, 15 cm, 10 Ch/Fr (3,3 mm) Frazier suction tube, 15 cm, 10 Ch/Fr (3.3 mm)
DR095011891	Diamantbohrer, 95 mm, 1,8 mm mittel Diamond bur, 95 mm, 1.8 mm, medium	30-749-21	Saug- und Spülrohr, 15 cm, 2,5 / 2,0 mm Suction/irrigation tube, 15 cm, 2.5 / 2.0 mm
DR095012791	Diamantbohrer, 95 mm, 2,7 mm mittel Diamond bur, 95 mm, 2.7 mm, medium	30-755-00	Federhaken nach Yasargil, klein, 30 cm Yasargil feather hook, small, 30 cm
DR095013591	Diamantbohrer, 95 mm, 3,5 mm mittel Diamond bur, 95 mm, 3.5 mm, medium	30-770-30	Yasargil Pinzette, ringförmig, 22 cm Yasargil dressing forceps, ring ended, 22 cm
DR095014591	Diamantbohrer, 95 mm, 4,5 mm mittel Diamond bur, 95 mm, 4.5 mm, medium	30-759-21	Tönnis Gefäßraspatorium, 21,5 cm Tönnis raspatorry, 21.5 cm
DR095016091	Diamantbohrer, 95 mm, 6,0 mm mittel Diamond bur, 95 mm, 6.0 mm, medium	80-125-07	Bipolare Koagulationspinzette, NON-STICK, bajonett, Führungsstift 22,5 cm, 0,7 mm Bipolar coagulation forceps, NON-STICK, bayonet, guide pin, 22.5 cm, 0.7 mm
DR095013593	Diamantbohrer, 95 mm, 3,5 mm, grob Diamond bur, 95 mm, 3.5 mm, coarse	80-018-45	Bipolares Anschlusskabel, 4,5 m, für Erbe/Storz Bipolar cable, 4.5 m, for Erbe/Storz
DR095016093	Diamantbohrer, 95 mm, 6,0 mm, grob Diamond bur, 95 mm, 6.0 mm, coarse		
30-700-00	Flexibler Spannarm für Spekula, mit Verlängerung Flexible holding arm for specula, incl. holding rods		
30-700-01	Gelenkkloben zur Befestigung am OP-Tisch Rotation clamp for fixation to operating table		
30-705-55	NNH-Spekulum für Erw., 13,5 cm, 55 mm linkes Blatt Sinus speculum f. adults, 13.5 cm, 55 mm left blade		
30-705-75	NNH-Spekulum f. Erw., 13,5 cm, 75 mm linkes Blatt Sinus speculum f. adults, 13.5 cm, 75 mm left blade		
30-706-55	NNH-Spekulum f. Erw., 13,5 cm, 55 mm rechtes Blatt Sinus speculum f. adults, 13.5 cm, 55 mm right blade		
30-706-75	NNH-Spekulum f. Erw., 13,5 cm, 75 mm rechtes Blatt Sinus speculum f. adults, 13.5 cm, 75 mm right blade		
30-720-16	Draf Siebbeinzängchen, 4 x 1,8 mm, 16 cm, gerade Draf ethmoid forceps, 4 x 1.8 mm, 16 cm, straight		
30-722-16	Draf Siebbeinzängchen, 4 x 1,8 mm, 16 cm, 45° aufgebogen Draf ethmoid forceps, 4 x 1.8 mm, 16 cm, 45° angled		
30-724-16	Draf Siebbeinzängchen, 4 x 1,8 mm, 16 cm, 90° aufgebogen Draf ethmoid forceps, 4 x 1.8 mm, 16 cm, 90° angled		
30-726-16	Draf Siebbeinzängchen, 3 x 1,5 mm, 16 cm, gerade Draf ethmoid forceps, 3 x 1.5 mm, 16 cm, straight		
30-728-16	Draf Siebbeinzängchen, fein gerieft, 16 cm, gerade Draf ethmoid forceps, fine serrated, 16 cm, straight		
30-732-16	Draf Siebbeinscherchen, gerade, 16 cm Draf ethmoid scissors, straight, 16 cm		
30-740-10	Draf Mikroraspatorium, 25 cm, 1 mm, leicht gebogen Draf micro raspatorry, 25 cm, 1 mm, angled		
30-740-30	Draf Mikroraspatorium, 25 cm, 3 mm, leicht gebogen Draf micro raspatorry, 25 cm, 3 mm, slightly curved		
30-740-31	Draf Mikroraspatorium, 25 cm, 3 mm, stark gebogen Draf micro raspatorry, 25 cm, 3 mm, strongly curved		
30-740-40	Draf Mikroraspatorium, 25 cm, 4 mm, gewinkelt Draf micro raspatorry, 25 cm, 4 mm, angled		
30-742-19	Draf Sichelmesser, 19 cm, gebogen Draf sickle knife, 19 cm, curved		



Bezeichnung	Seite	Bezeichnung	Seite	Bezeichnung	Seite
Adson-Brown Pinzette	20	Kerrison Keilbeinstanze	44	Spiegel	55
Antrum-Kürette	27	Kieferhöhlen Polypen-Fasszange	32	Spiegel-Handgriff.....	55
Antrum-Löffel	27	Kieferhöhlen-Watteträger	8	Tablettenschale	59
Antrum-Trokar.....	13	Kieferhöhlen-Sonde	29	Takahashi Nasenzange	26, 35
Antrumstanze, rückwärts schneidend	30, 31	Kieferhöhlen-Spülschlauch	7	Tellermesser.....	53
Antrumstanze, seitwärts schneidend	31	Killian-Struycken Septumspekulum	19	Tobey Mikro-Antrumstanze	31
Beyer Knochenstanze für Kinder	41	Korzangenbehälter	60	Tönnis Gefäßraspatorium	48
Binner Polypenfasszange	38	Knochenstanze mit Reservoir	40, 41	Uffenorde Kieferhöhlenlöffel.....	56
Biopsiezange.....	8, 39	Krause Nasenpolypenschnürer	22	Ultra-Stop Antibeschlagmittel	14
Bipolare Koagulationspinzette.....	49	Langenbeck Wundhaken	58	USB-CCD-Kamera	17
Bipolare Pinzette.....	23	Langenbeck-Green Wundhaken.....	58	Walter Schere	19
Bipolares Anschlusskabel	23, 49	LED-Leuchtgriff	14	Watteträger	20
Blakesley Nasenzange	24- 26, 35, 36	Lichtleitkabel	18	Weber Doppellevatorium.....	21
Brünings-Brunk Wundhaken	57	Lichtwitz Punktionskanüle	7	Weber Nasenschere	29
CCD-Videokamera	17	Löffelkurette	50, 51, 54	West Flachmeißel	57
Coakley Kieferhöhlenkurette	56	Löffelzange	33	West Hohlmeißel.....	57
Coakley Kieferhöhlentrokar.....	7	Lösungsschale	59	Wigand durchschneidende Zange	34
Codierschild	61	Mandrin	40	Wigand Polypen-Fasszange	25
Conchotomie Schere.....	28	Masing Elevatorium/Raspatorium.....	21	Wigand Stirnhöhlenraspel	28
Container-Siegel	61	Masing Ritzmesser.....	20	Yasargil Pinzette.....	48
Cottle Columella-Klemme	20	Matrix LED 100 duo	17		
Cottle Hammer	21	McKenty Keilbeinstanze	43		
Cottle Meißel.....	22	Medikamentenschälchen	59, 60		
Cottle Nasenflügelhaken	23	Medizinbecher	59		
Cottle Septum-Messer	20	Metallschale	59		
Crile-Wood Nadelhalter	22	Middeldorpf Wundhaken	58		
Desinfektions Wandhalterung für Endoskope	18	Mikro-Häkchen.....	54		
Desinfektions-System für Endoskope	12, 62	Muck Saugglas mit Stopfen	7		
Dissektor.....	53	Mukosa Dissektor	54		
Draf Incisionsmesser	47	Nasenpolypenschlingen	22		
Draf Mikroraspatorium.....	47	Nasensonde S-förmig.....	22		
Draf Rundschnittmesser.....	47	Nierenschale	60		
Draf Sichelmesser	47	NNH-Spekulum.....	45		
Draf Siebbeinscherchen	46	Norm-Sterilisationscontainer	61		
Draf Siebbeinzängchen	46	Ölspray für Instrumente	58		
Durchschneidende Nasenzange	33	Optische Biopsiezange.....	8		
Durchschneidende Saugzange	35	Orbita Gelenksperrer	57		
Eicken Punktionskanüle.....	7	Orbitaschützer	56		
Eicken Spülröhrchen	5	Pädiatrisches FESS-SET.....	64		
Endoskope.....	9-12	Petrischale.....	59		
Endoskop-Schutzhülse	13	Porzellanschälchen.....	60		
Enucleator	52	Raspatorium	52		
Entsorgungsmarke.....	61	Reinigungsspray.....	58		
Federhaken nach Yasargil.....	48	Reynolds Schere.....	19		
FESS-Basis-Set.....	63	Ritter Stirnhöhlenbougie.....	8		
Fiberglas-Lichtleitkabel	18	Ringkurette.....	53		
Fisch Wundsperrer.....	49	Rundkopfstanze für Keilbeinhöhle	40		
Flexible Alligatorzange	16	Rundkopfstanze für Stirnhöhle	37		
Flexible Löffelzange	16	Saug- und Spülhandgriff	14		
Flexibler Spannarm	45	Saug- und Spülrohr	48		
Flexibles Endoskop	15, 16	Saug- und Spülschaft.....	14		
Frazier Saugrohr	5, 6, 48	Schädelbasis-Set.....	65		
Freer Doppellevatorium.....	21	Schwager Stanze	42		
Gelenkkloben.....	45	Sewall Kieferhöhlenelevatorium	57		
Guillen Saugraspatorium.....	21	Sichelmesser	27, 52		
Haken	53	Siebkorb	61		
Handgriff für Endoskope	13	Sinuskop, HD (starr/semiflex)	9-12		
Hajak-Kofler Keilbeinstanze	42, 43	Sondenhäkchen	52		
Halle Kieferhöhlenkurette	56	Sterilisations-System "InstruSafe"	62		
Halle Kieferhöhlenlöffel.....	56	Sternberg Lippenhaken.....	57		
Hartmann Nasenspekulum	5	Stirnhöhlenbiopsiezange	39		
Hartmann Nasentamponadezange	25	Stirnhöhlenlöffel.....	28		
Herberhold cranial durchschneidende Zange.....	34	Stirnhöhlenlöffelzange	38		
Hochleistungs-Fiberglas-Lichtleitkabel	18	Stirnhöhlensaugraspatorium.....	6		
House Löffel.....	47	Stirnhöhlensaugrohr	6		
Indikator-Klebetikett.....	61	Stirnhöhlensonde	29		
Injektionskanüle	8	Stirnhöhlenstanze	37		
Jansen Nasenpinzette	20	Stirnhöhlenzange.....	39		
Joseph Schere.....	19	Strümpel-Voss Nasenzange	26		



Alphabetical Content

Description	Page	Description	Page	Description	Page
Adhesive indicator label	61	Frontal sinus suction tube	6	Skull base Set	65
Adson-Brown forceps	20	Guillen suction raspatory	21	Sphenoid sinus circular punch	40
Antrum curette	27	Hajak-Kofler sphenoid punch	42, 43	Spoon curette	50, 51, 54
Antrum polyp grasping forceps	32	Halle antrum curette	56	Sterilizing system "Instru Safe"	62
Antrum punch with collector	40, 41	Hartmann nasal dressing forceps	25	Sternberg lip retractor	57
Antrum punch	30, 31, 41	Hartmann nasal speculum	5	Strümpel-Voss nasal forceps	26
Antrum trocar	13	Herberhold cranial throughcutting forceps	34	Stylet	40
Basket	61	High definition fibre light cable	18	Suction/Irrigation tube	48
Beyer antrum punch	41	Hook	53	Suction- and irrigation handle	14
Binner polyp forceps	38	House curette	47	Suction- and irrigation sheath	14
Biopsy forceps	8	Injection needle	8	Tablet dish	59
Bipolar cable	23, 49	Jansen nasal forceps	20	Takahashi nasal forceps	26
Bipolar coagulation forceps	49	Joseph scissors	19	Takahashi suction forceps	35
Bipolar forceps	23	Kerrison sphenoid punch	44	Tobey micro antrum punch	31
Blakesley nasal forceps	24-26, 35, 36	Kidney bowl	60	Tönnis raspatory	48
Brünings-Brunk retractor	57	Killian-Struycken nasal speculum	19	Throughcutting nasal forceps	33
CCD video camera	17	Krause nasal polyp snare	22	Throughcutting suction forceps	35
China bowl	60	Langenbeck-Green retractor	58	Uffenorde antrum curette	56
Clip on coding clamp	61	Langenbeck retractor	58	Ultra-Stop anti-fog solution	14
Coakley antrum curette	56	Large picture endoscope	9	Walter scissors	19
Coakley sinus trocar	7	LED light handles	14	Weber elevator	21
Coding labels	61	Lichtwitz trocar needle	7	Weber nasal scissors	29
Container seal	61	Masing elevator/raspatory	21	West chisel	57
Cottle alar retractor	23	Masing pointed knife	20	West gouge	57
Cottle chisel	22	Matrix LED 100 duo	17	Wigand frontal sinus rasp	28
Cottle columella forceps	20	Maxilliary sinus cotton carrier	8	Wigand polyp grasping forceps	25
Cottle mallet	21	Maxillary sinus seeker	29	Wigand throughcutting forceps	34
Cottle septum knife	20	McKenty sphenoid punch	43	Yasargil dressing forceps	48
Cotton carrier	8, 20	Medicine cup	59	Yasargil feather hook	48
Crile-Wood needleholder	22	Medication dish	59, 60		
Cup forceps	33	Metal bowl	59		
Dissector	53	Micro hook	54		
Disinfection wall holder for endoscopes	18	Middeldorpf antrum retractor	58		
Draf ethmoid forceps	46	Mirror	55		
Draf ethmoid scissors	46	Mirror handle	55		
Draf flap knife	47	Mucosa dissector	54		
Draf micro raspatory	47	Muck suction bottle	7		
Draf round knife	47	Nasal conchotomy scissors	28		
Draf sickle knife	47	Nasal polyp snare wires	22		
Eicken antrum cannula	5	Nasal probe	22		
Eicken trocar needle	7	Norm sterilization container	61		
Endoscope	9	Oil spray for instruments	58		
Endoscope container with lid	62	Optical biopsy forceps	8		
Endoscope handle	13	Orbita protector	56		
Endoscope protection sleeve	13	Orbita retractor	57		
Endoscope sterilizing/protecting tray	12, 62	Pediatric FESS-Set	64		
Enucleator	52	Petri dish	59		
FESS-Basic-Set	63	Probe hook	52		
Fibre light cable	18	Raspatory	52		
Fisch Retractor	49	Reynolds scissors	19		
Flexible alligator forceps	16	Ring curette	53		
Flexible cup forceps	16	Ritter frontal sinus bougie	8		
Flexible endoscope	15, 16	Rotation clamp for fixation to operating table	45		
Flexible holding arm	45	Schwager punch	42		
Forceps holder	60	Seperator	53		
Frazier suction tube	5, 6, 48	Sewall antrum elevator	57		
Freer double elevator	21	Sickle knife	27, 52		
Frontal sinus biopsy forceps	39	Sinus irrigation tube	7		
Frontal sinus circular punch	37	Sinus speculum for adults	45		
Frontal sinus curette	28	Sinus speculum for children	45		
Frontal sinus forceps	38, 39	Sinus suction raspatory	6		
Frontal sinus punch	37	Sinus suction tube	6		
Frontal sinus seeker	29	Sinuscope	10-12		
Frontal sinus suction raspatory	6	Solution bowl	59		





10-129-30 11	20-710-12 20	30-142-45 11	30-333-02 34
10-129-70 11	20-730-16 20	30-142-70 11	30-333-12 34
10-468-17 49	20-730-19 20	30-151-27 13	30-340-01 35
20-100-01 5	20-740-15 22	30-151-40 13	30-340-02 35
20-100-02 5	20-800-16 20	30-155-50 13	30-340-03 35
20-150-40 19	20-801-16 20	30-156-33 13	30-342-01 36
20-150-55 19	20-802-16 20	30-156-40 13	30-342-02 36
20-150-75 19	30-080-05 5	30-156-50 13	30-342-03 36
20-150-90 19	30-080-06 5	30-160-01 14	30-343-01 36
20-190-25 22	30-080-07 5	30-160-02 14	30-343-02 36
20-195-35 22	30-080-08 5	30-160-03 14	30-343-03 36
20-200-16 25	30-080-09 5	30-161-00 14	30-343-04 36
20-200-20 25	30-080-10 5	30-164-00 14	30-343-11 36
20-215-00 24	30-080-12 5	30-164-30 14	30-343-12 36
20-215-01 24	30-080-15 5	30-164-45 14	30-343-13 36
20-215-02 24	30-082-08 6	30-164-70 14	30-343-14 36
20-215-03 24	30-082-10 6	30-167-00 14	30-344-00 35
20-215-04 24	30-082-12 6	30-167-30 14	30-344-45 35
20-225-00 24	30-082-15 6	30-170-28 15, 16	30-346-00 35
20-225-01 24	30-084-01 6	30-170-36 15	30-346-30 35
20-225-02 24	30-084-02 6	30-171-40 15, 16	30-400-00 37
20-225-03 24	30-100-25 5	30-172-40 16	30-400-01 37
20-225-04 24	30-100-30 5	30-173-40 16	30-401-01 39
20-225-11 25	30-100-40 5	30-182-21 13	30-401-02 39
20-225-12 25	30-101-25 5	30-200-01 27	30-402-01 39
20-225-14 25	30-101-30 5	30-200-02 27	30-402-02 39
20-235-01 24	30-101-40 5	30-200-03 27	30-404-01 38
20-235-02 24	30-102-25 5	30-200-04 27	30-404-02 38
20-235-03 24	30-102-30 5	30-203-01 27	30-405-01 38
20-236-00 25	30-102-40 5	30-203-02 27	30-405-02 38
20-238-00 26	30-105-06 6	30-205-01 27	30-405-11 38
20-240-01 26	30-105-08 6	30-205-02 27	30-405-12 38
20-240-02 26	30-105-10 6	30-205-03 27	30-407-01 38
20-240-11 26	30-106-25 6	30-205-04 28	30-407-02 38
20-240-12 26	30-106-30 6	30-205-06 28	30-408-01 38
20-245-01 26	30-106-40 6	30-205-70 28	30-408-02 38
20-245-02 26	30-108-00 6	30-207-01 29	30-410-01 39
20-245-11 26	30-110-16 7	30-207-02 29	30-410-02 39
20-245-12 26	30-110-18 7	30-207-03 29	30-411-01 39
20-246-01 26	30-110-20 7	30-209-01 28	30-411-02 39
20-246-02 26	30-111-16 7	30-300-01 30	30-415-01 38
20-300-21 21	30-111-18 7	30-300-02 30	30-415-02 38
20-305-18 21	30-111-20 7	30-300-03 30	30-421-35 37
20-306-20 21	30-112-00 7	30-302-01 30	30-421-45 37
20-307-18 21	30-113-00 7	30-302-02 30	30-422-35 40
20-313-00 22	30-114-16 7	30-302-03 30	30-422-45 40
20-322-01 21	30-120-07 8	30-304-15 31	30-425-35 37
20-322-02 21	30-121-25 8	30-304-25 31	30-425-45 37
20-322-03 21	30-121-30 8	30-305-00 31	30-428-35 37
20-323-01 21	30-121-40 8	30-306-00 31	30-428-45 37
20-323-02 21	30-121-50 8	30-307-00 31	30-429-35 40
20-323-03 21	30-122-08 8	30-308-01 31	30-429-45 40
20-400-18 21	30-125-00 8	30-308-02 31	30-450-20 40
20-405-04 22	30-126-00 8	30-310-01 32	30-450-30 41
20-405-07 22	30-130-00 11	30-310-02 32	30-450-90 40
20-405-09 22	30-130-30 11	30-311-01 32	30-454-20 43
20-405-10 22	30-130-70 11	30-311-02 32	30-456-32 42
20-405-12 22	30-131-00 10	30-320-01 33	30-457-15 41
20-500-13 20	30-131-30 10	30-320-02 33	30-468-10 44
20-501-14 20	30-132-00 12	30-321-01 33	30-468-20 44
20-502-14 20	30-132-30 12	30-321-02 33	30-468-30 44
20-560-15 23	30-132-45 12	30-322-01 33	30-468-40 44
20-601-14 19	30-134-00 12	30-322-02 33	30-468-50 44
20-610-15 19	30-134-30 12	30-328-01 33	30-469-10 44
20-630-10 19	30-134-45 12	30-330-01 34	30-469-20 44
20-690-01 28	30-134-70 12	30-330-02 34	30-469-30 44
20-690-02 28	30-135-00 10	30-332-01 34	30-469-40 44
20-690-03 28	30-135-30 10	30-332-02 34	30-469-50 44
20-691-01 29	30-142-00 11	30-332-12 34	30-471-10 44
20-700-10 20	30-142-30 11	30-333-01 34	30-471-20 44



Numeric Content

30-471-30	44	30-807-01	56	80-528-18	60	90-214-00	54
30-473-10	44	30-807-02	56	80-528-20	60	90-215-00	54
30-473-20	44	30-807-03	56	80-530-20	60	90-220-00	55
30-473-30	44	30-809-01	56	80-611-10	62	90-222-04	55
30-475-01	42	30-809-02	56	80-621-05	12	90-222-05	55
30-475-02	42	30-812-24	56	80-622-56	12	90-222-06	55
30-477-20	44	30-814-19	57	80-623-22	12	90-222-08	55
30-477-40	44	30-816-40	57	80-630-12	61	90-222-10	55
30-490-40	43	30-817-40	57	80-630-21	61	90-222-12	55
30-491-40	43	30-900-00	63	80-650-00	58		
30-492-40	43	30-902-00	65	80-660-14	61		
30-493-40	43	30-905-00	64	80-660-21	61		
30-494-40	43	70-101-00	17	80-670-25	61		
30-700-00	45	70-202-00	17	80-670-40	61		
30-700-01	45	70-210-00	14	80-670-49	61		
30-702-25	45	70-210-90	14	80-680-01	61		
30-703-25	45	70-210-91	14	80-680-02	61		
30-705-55	45	70-210-93	14	80-680-03	61		
30-705-65	45	70-210-94	14	80-680-04	61		
30-705-75	45	70-258-35	18	80-680-05	61		
30-706-55	45	70-259-35	18	80-680-06	61		
30-706-65	45	70-260-35	18	80-680-07	61		
30-706-75	45	70-265-01	18	80-683-00	61		
30-720-13	46	70-265-02	18	80-684-00	61		
30-720-16	46	70-472-00	18	80-685-00	61		
30-720-19	46	80-016-45	23, 50	80-690-01	62		
30-722-13	46	80-017-45	23, 50	80-690-02	62		
30-722-16	46	80-018-45	23, 50	80-691-01	62		
30-722-19	46	80-019-45	23, 50	80-692-01	62		
30-724-13	46	80-110-16	23	90-201-01	50		
30-724-16	46	80-125-03	49	90-201-02	50		
30-724-19	46	80-125-07	49	90-201-03	50		
30-726-13	46	80-125-12	49	90-201-04	50		
30-726-16	46	80-302-12	57	90-201-05	50		
30-728-16	46	80-302-14	57	90-201-06	50		
30-729-16	46	80-302-16	57	90-201-07	50		
30-732-13	46	80-304-00	57	90-201-08	50		
30-732-16	46	80-306-17	58	90-201-09	50		
30-732-19	46	80-306-22	58	90-201-14	51		
30-733-16	46	80-306-30	58	90-201-15	51		
30-734-16	46	80-308-07	58	90-201-16	51		
30-735-19	46	80-308-10	58	90-201-17	51		
30-740-10	47	80-308-15	58	90-201-18	51		
30-740-30	47	80-308-20	58	90-201-19	51		
30-740-31	47	80-310-01	57	90-201-28	51		
30-740-40	47	80-310-02	57	90-201-29	51		
30-742-19	47	80-334-16	58	90-202-01	52		
30-743-19	47	80-501-01	59	90-202-02	52		
30-744-19	47	80-501-02	59	90-204-01	52		
30-747-06	48	80-501-03	59	90-204-02	52		
30-747-07	48	80-501-04	59	90-206-01	52		
30-747-08	48	80-503-03	59	90-206-02	52		
30-747-09	48	80-504-05	59	90-206-03	52		
30-747-10	48	80-506-30	59	90-206-04	52		
30-747-12	48	80-507-40	59	90-208-01	52		
30-747-15	48	80-509-75	59	90-208-02	52		
30-749-15	48	80-512-00	59	90-210-01	53		
30-755-00	48	80-515-06	59	90-210-02	53		
30-755-01	48	80-515-08	59	90-210-03	53		
30-757-21	47	80-515-10	59	90-210-04	53		
30-759-21	48	80-517-00	59	90-210-05	53		
30-770-30	48	80-519-00	60	90-210-06	53		
30-770-50	48	80-519-01	60	90-210-07	53		
30-800-01	56	80-519-02	60	90-210-08	53		
30-800-02	56	80-519-03	60	90-210-09	53		
30-800-03	56	80-520-06	60	90-210-10	53		
30-800-04	56	80-520-08	60	90-211-01	54		
30-800-05	56	80-525-17	60	90-212-01	54		
30-800-06	56	80-525-25	60	90-212-02	54		
30-805-00	56	80-528-13	60	90-212-03	54		







Deutsch



International

Spiggle & Theis Medizintechnik GmbH ist auch über Mobilgeräte wie Smartphones und Tablet-PCs erreichbar – einfach QR-Code scannen!
Spiggle & Theis Medizintechnik GmbH is also available for mobile devices like smart phones and tablet PC – simply scan QR code!

SPIGGLE & THEIS

Medizintechnik GmbH

Burghof 14

51491 Overath / Germany

Tel.: +49 (0) 2206 / 90 81 - 0

Fax: +49 (0) 2206 / 90 81 -13

info@spiggle-theis.de

www.spiggle-theis.de

www.spiggle-theis.com

© 2016 by Spiggle & Theis Medizintechnik GmbH

Änderungen und Druckfehler – auch für Bilder – vorbehalten.

Bitte beachten Sie auch, dass ggf. nicht alle Produkte in Ihrem Land vertrieben werden.

Modifications and errors – including pictures – reserved.

Please note also that not all goods might be for sale in your country.