

Mundhöhlen-Instrumentarium

Oral Cavity Instruments

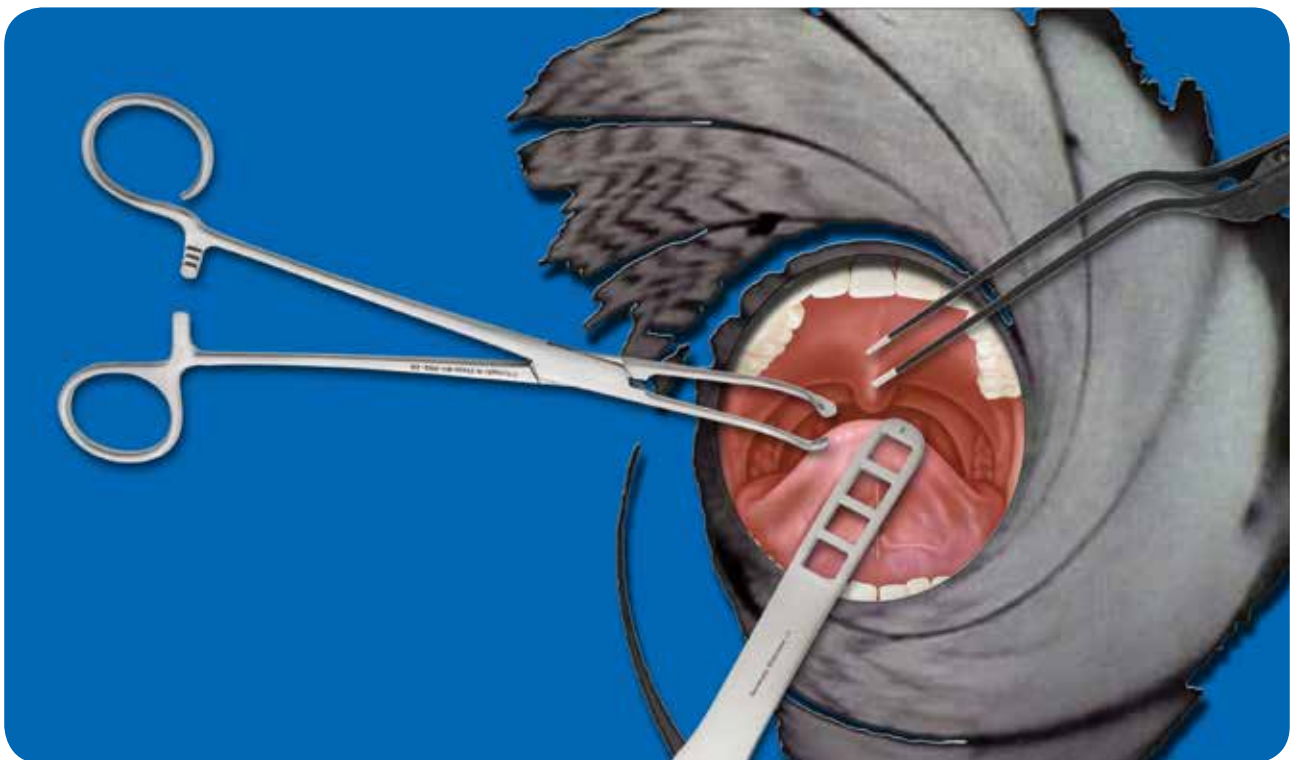



GESCHICHTE

Spiggle & Theis Medizintechnik GmbH wurde 1994 von den beiden Geschäftsführern David Spiggle und Detlef Theis gegründet. Bis heute haben wir uns vom reinen Vertriebsunternehmen zu einem renommierten Hersteller von Medizinprodukten im Bereich der HNO-Chirurgie weiterentwickelt. Zu unseren Kunden in Deutschland zählen mehr als 700 Kliniken und wir exportieren mittlerweile in über 75 Länder weltweit.



HISTORY

Spiggle & Theis Medizintechnik GmbH was founded in 1994 by both the managing directors David Spiggle and Detlef Theis. The company evolved from being purely a distributor to the established manufacturer of medical products in the area of ENT that it is today. We can count over 700 clinics amongst our German customers and we export to over 75 countries worldwide.

DAS MASS DER DINGE

Im chirurgischen Instrumentenbau gilt das Siegel "MADE IN GERMANY" auch heute noch als Inbegriff von Qualität. Unsere chirurgischen Instrumente werden in allen Produktionsstufen unter strengsten Qualitätsanforderungen in Deutschland produziert, sind also noch echt "MADE IN GERMANY". Zur Verarbeitung wird ausschließlich Instrumentenstahl bester Güte verwendet, welcher den hohen Anforderungen moderner Chirurgie auch dauerhaft gerecht wird.

THE SEAL OF HIGHEST QUALITY

The stamp "MADE IN GERMANY" is still the epitome of quality standards in the production of surgical instruments in the world today. In Germany, our surgical instruments are subjected to the strictest quality requirements at every step of their production, so they are, in the truest sense of the words, "MADE IN GERMANY". Only the highest standard of instrument steel, capable of consistently meeting the demands of modern surgery, is used in the production.

SICHERHEIT ZUERST

Die Gesundheit der Patienten und somit die Sicherheit und Qualität unserer Produkte stehen immer im Mittelpunkt unseres Handelns. In diesem Sinne ist Spiggle & Theis Medizintechnik GmbH bereits seit 1997 ISO-zertifiziert und unsere Produkte nach der strengen europäischen Richtlinie für Medizinprodukte CE-zertifiziert. Alle unsere Produkte unterliegen einem permanenten Prozess der Qualitätskontrolle, von der Auswahl des Rohmaterials über die einzelnen Fertigungsschritte bis zum Versand.



SAFETY FIRST

The health of our patients and therefore the safety and quality of our products always plays a central role in our decisions. Spiggle & Theis Medizintechnik GmbH has been ISO certified and our products are CE-certified in accordance with the strict European guidelines for medical products since 1997. All our products undergo continual quality checks, from the selection of raw materials, to the individual stages of production and finally their dispatch.

SERVICE

Unsere Kollegen blicken zum Teil auf mehr als 30 Jahre Berufserfahrung im Umgang mit chirurgischen Instrumenten zurück. Dadurch besitzen wir mehr als theoretisches Wissen – Verständnis für die Bedürfnisse unserer Kunden. Darüber hinaus pflegen wir noch den engen, individuellen Kontakt mit den Anwendern. Dies hilft uns bei der steten, praxisorientierten Weiterentwicklung unserer Produkte. Somit garantieren wir hohe Kompetenz und individuellen Service bei der Betreuung unserer Kunden.



SERVICE

Our colleagues in instrument development can look back on over 30 individual years of professional practical experience with ENT-surgical instruments. We offer more than theoretical knowledge – we understand our customers needs. We enjoy close, personal contact to many of the best surgeons here in Germany. This enables us to continually develop innovative products. We guarantee the highest level of competence and individual service in meeting our customers requirements.



Contents

1	Endoskopie.....	5 - 9
1	Endoscopy.....	5 - 9
2	Adenotomie.....	10 - 14
2	Adenotomy.....	10 - 14
3	Tonsillektomie.....	15 - 33
3	Tonsillectomy.....	15 - 33
4	Kehlkopf.....	34 - 38
4	Larynx.....	34 - 38
5	Speichelgang.....	40 - 45
5	Salivary Duct.....	40 - 45
6	Koagulation.....	46 - 58
6	Coagulation.....	46 - 58
7	Tracheotomie, Weichteile, Allgemeines.....	59 - 73
7	Tracheotomy, Neck Dissection, Miscellaneous.....	59 - 73
8	Instrumentensets.....	74
8	Instrument Sets.....	74
	Index.....	75 - 78
	Index.....	75 - 78





Schaftdurchmesser	3,4 mm
Shaft diameter	3.4 mm
Arbeitslänge	32 cm
Working length	32 cm
Abwinkelung (auf / ab)	130°
Angle (up / down)	130°
Biegeradius	8 mm
Bending radius	8 mm
Blickfeld	80°
Field of vision	80°
Tiefenschärfe	1–50 mm
Depth of focus	1–50 mm
Gewicht	230 g
Weight	230 g

Flexibles Nasopharyngoskop

Flexible nasopharyngoscope

30-170-36

Die Spiggle & Theis Nasopharyngoskope der neuen Generation sind intuitiv bedienbar und ergonomisch optimal geformt, entwickelt für die notwendige Feinfühligkeit im täglichen Routineeinsatz und eine ermüdungsfreie Handhabung.

Hochwertige Bildleiter und ein leistungsfähiges optisches System liefern große und helle Bilder bester Auflösung – die Voraussetzung für eine sichere Diagnose und Therapie. Dank solider Verarbeitung und konsequenter Verwendung moderner Hochleistungswerkstoffe sind Spiggle & Theis Nasopharyngoskope robuster und langlebiger – trotz steigender Belastung durch moderne Aufbereitungsverfahren.

The new generation Spiggle & Theis nasopharyngoscopes impress with intuitive operability and optimal ergonomics, designed for tactile sensation and non-tiring handling as required in daily routine operations.

High-end fibre-optic bundles and a high-capacity system produce large and bright images of the best quality – necessary for safe diagnosis and treatment. Due to the consistent use and reliable processing of high-class materials, the Spiggle & Theis nasopharyngoscopes are robust and durable, in spite of the increasing stress of modern cleaning and sterilizing facilities.

- funktionelles Design für eine entspannte, angenehme Handhabung
- feinfühlig, aber robuste Steuerung
- optimale Flexibilität und Torsionssteifigkeit des Einführungsschafts
- leistungsfähiges optisches System: größere, hellere und schärfere Bilder
- geeignete Wiederaufbereitungsverfahren:
 - einlegbar in Reinigungs- und Desinfektionslösung
 - STERIS
 - NTDF-Sterilisation = Niedertemperatur-Dampf-Formaldehyd-Sterilisation
 - maschinelle Aufbereitung (RDG-E)
- functional design for easy and comfortable handling
- sensitive yet robust control
- optimal flexibility and torsional rigidity of the insertion channel
- high-performance optical system for larger, brighter and sharper images
- suitable reprocessing procedures:
 - fully immersible in cleaning and disinfectant solutions
 - STERIS
 - LTSF-sterilization = Low-Temperature Steam and Formaldehyde-sterilization
 - machine reprocessing (RDG-E)



Endoscopy



Flexibles Nasopharyngoskop
Flexible nasopharyngoscope

30-170-28 2,8 mm \varnothing ,
32 cm Arbeitslänge /
Working length

Flexibles Nasopharyngoskop
Flexible nasopharyngoscope

30-171-40 4,0 mm \varnothing ,
1,4 mm \varnothing Arbeitskanal /
Working channel,
32 cm Arbeitslänge /
Working length

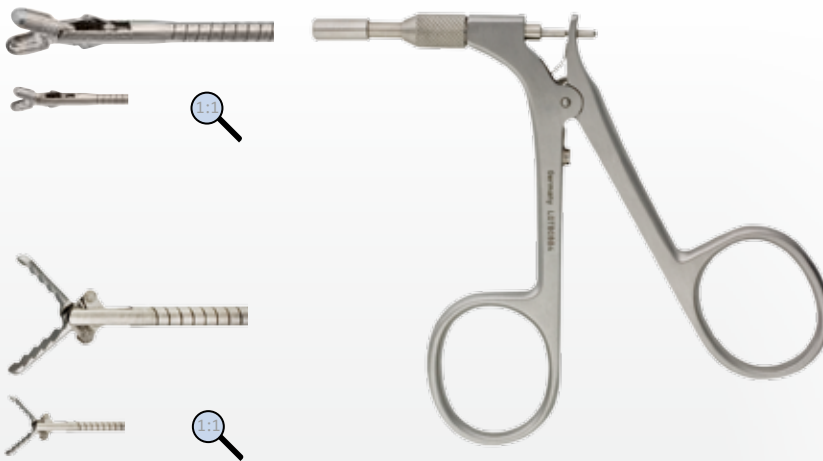

**Flexible Löffelzange, 1,2 mm, 40 cm,
Ringgriff, ovales Löffelmaul**
Flexible cup forceps, 1.2 mm, 40 cm,
ring handle, oval cups

30-172-40

**Flexible Alligatorzange, 1,2 mm,
40 cm, Ringgriff, gezahntes Maul**
Flexible alligator forceps, 1.2 mm,
40 cm, ring handle, toothed jaws

30-173-40



**Flexible Reinigungsbürste mit Ringgriff,
einseitig, 1,2 mm, 40 cm,
für flexibles Nasopharyngoskop 30-171-40**
Flexible cleaning brush with ring handle,
one-sided, 1.2 mm, 40 cm,
for flexible nasopharyngoscope 30-171-40

30-174-40



Endoskop, HD, autoklavierbar, 30,2 cm
Endoscope, HD, autoclavable, 30.2 cm

	AD / OD	Winkel / Angle
40-110-00	2,7 mm ○	0°
40-110-30	2,7 mm ○	30°
40-110-70	2,7 mm ○	70°
40-112-00	4,0 mm ○	0°
40-112-30	4,0 mm ○	30°
40-112-70	4,0 mm ○	70°

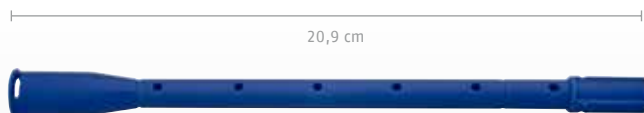

Endoskop-Schutzhülse, 20,9 cm, verlängerbar, autoklavierbar, für Endoskop 40-110-xx oder 40-112-xx. (Für 40-112-xx werden 2 Schutzhülsen benötigt)
Endoscope protection sleeve, 20.9 cm, extendable, autoclavable, for endoscope 40-110-xx or 40-112-xx. (Two protection sleeves are needed for 40-112-xx)

30-182-21



Endoskopie Sterilisations-Container für Endoskope Ø 2,5 - 5,0 mm, bis 19,5 cm Länge, 1 Lichtkabel, 1 Kamerakopf, 1 Stück
Endoscope sterilizing & protecting tray for endoscopes Ø 2.5 - 5.0 mm, up to 19.5 cm length, 1 light cable, 1 camera head, 1piece

- 80-621-05 für 2 Endoskope / for 2 endoscopes
- 80-622-56 für 6 Endoskope / for 6 endoscopes
- 80-623-22 für Endoskope / for endoscopes

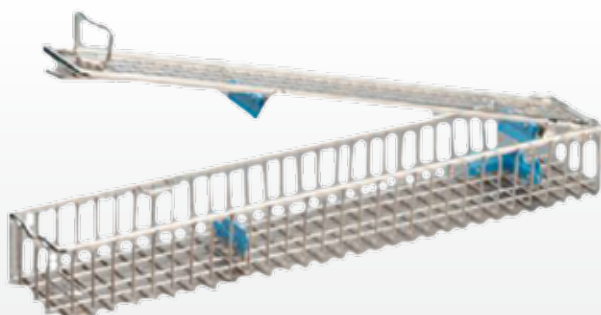

Endoskopie-Siebkorb mit Deckel, Edelstahl, epoliert
Endoscope container with lid, stainless steel, e-polished

- 80-691-01 46 x 8 x 5,2 cm für 1 Endoskop / for 1 endoscope
- 80-692-01 67 x 8 x 5,2 cm für 1 Endoskop / for 1 endoscope

Endoscopy



LED-Leuchtgriffe
LED light handles

70-211-00 LED-Hochleistungs-Leuchtgriff, 230 V, bestehend aus: (70-211-10, 70-211-20, 70-211-30, 70-211-40) / LED high performance light-handle, 230 V, consisting of: (70-211-10, 70-211-20, 70-211-30, 70-211-40)



70-211-01 LED-Hochleistungs-Leuchtgriff, 120 V, bestehend aus: (70-211-10, 70-211-20, 70-211-30, 70-211-50) / LED high performance light-handle, 120 V, consisting of: (70-211-10, 70-211-20, 70-211-30, 70-211-50)

70-211-10 LED-Handgriff, schwarz, mit Helligkeitsdimmer, Ausschaltautomatik, 3 W, 5500°K, 17500 Lux, zur Verwendung mit Li-Io-Akku 3,5 V und Endoskop-Adapter, 50 Std. Brenndauer / LED light handle, black, with brightness dimmer, automatic switch-off, 3 W, 5500° K, 17500 lux, to use with Li-Io chargeable battery 3.5 V and endoscope adapter, 50 hours run-time



70-211-20 Li-Ionen-Akku, 3,5 V, für LED-Handgriff / Li-ion rechargeable battery, 3.5 V, for LED light-handle

70-211-30 Endoskopie-Adapter für LED-Handgriff, passend für Standardgewinde an Endoskopen (AcMI-Gewinde) / Endoscope adapter for LED light-handle, fits standard endoscope threads (AcMi-thread)

Endoscope adapter for LED light-handle, fits standard endoscope threads (AcMi-thread)



70-211-40 Ladegerät für bis zu 2 LED-Handgriffe, 3,5 V, 230 V, Standgerät, Wandhalterung / Charging base for up to 2 LED light-handles, 3.5 V, 230 V, table model, with wall holder

70-211-50 Ladegerät für bis zu 2 LED-Handgriffe, 3,5 V, 120 V, Standgerät, Wandhalterung / Charging base for up to 2 LED light-handles, 3.5 V, 120 V, table model, with wall holder



Ultra-Stop Antibeschlagmittel
Ultra-Stop Anti-Fog solution

- 30-160-01** 25 ml Pipettenflasche, unsteril / 25 ml pipette bottle, non-sterile
- 30-160-02** 30 ml Durchstichflasche, steril / 30 ml pierce bottle, sterile
- 30-160-03** 15 ml Sprayflasche, unsteril / 15 ml spray bottle, non-sterile

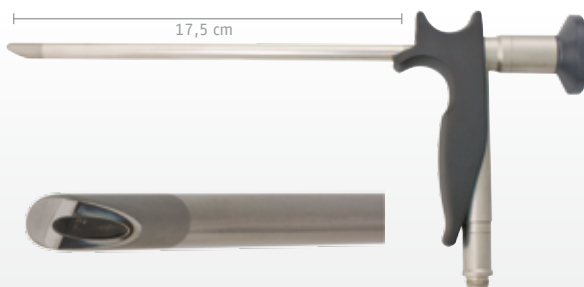

Laryngoskop, HD, autoklavierbar, 17,5 cm
Laryngoscope, HD, autoclavable, 17.5 cm

	AD / OD	Winkel / Angle
40-100-70	4 mm	70°
40-100-90	4 mm	90°





Laryngoskop, HD, autoklavierbar, Handgriff, integriertes Lichtleitkabel, 13,7 cm
 Laryngoscope, HD, autoclavable, handle, integrated light cable, 13.7 cm

	AD / OD	Winkel / Angle
40-108-70	7 mm	70°



Laryngoskop, HD, autoklavierbar, Handgriff, 19 cm
 Laryngoscope, HD, autoclavable, handle, 19 cm

	AD / OD	Winkel / Angle
40-103-70	10 mm	70°
40-103-90	10 mm	90°



Zoom Laryngoskop, HD, einlegbar, Handgriff, 20 cm
 Zoom laryngoscope, HD, soakable, handle, 20 cm

	AD / OD	Winkel / Angle
40-105-70	10 mm	70°
40-105-90	10 mm	90°



Laryngoskop, HD, autoklavierbar, 19 cm
 Laryngoscope, HD, autoclavable, 19 cm

	AD / OD	Winkel / Angle
40-107-70	8 mm	70°

Adenotomy



Beckmann Ringmesser, gerade
Beckmann adenoid curette, straight

	Größe / Size	Länge A / Length A	Länge Length
40-200-00	0	10,5 mm	22,0 cm
40-200-01	1	13,0 mm	22,0 cm
40-200-02	2	14,5 mm	22,0 cm
40-200-03	3	16,5 mm	22,5 cm
40-200-04	4	18,0 mm	23,0 cm



Negus Ringmesser, vorwärts gebogen, 21 cm
Negus adenoid curette, curved forwards, 21 cm

	Größe / Size	Länge A / Length A
40-203-00	0	11 mm
40-203-01	1	13 mm
40-203-02	2	15 mm
40-203-03	3	17 mm
40-203-04	4	18 mm



Stubbs Ringmesser, rückwärts gebogen, 22 cm
Stubbs adenoid curette, curved backwards, 22 cm

	Größe / Size	Länge A / Length A
40-206-00	0	11 mm
40-206-01	1	14 mm
40-206-02	2	16 mm
40-206-03	3	18 mm



**St.Clair-Thomson Ringmesser,
mit Fangkorb, 22,5 cm**
St.Clair-Thomson adenoid curette,
with basket, 22.5 cm

	Größe / Size	Länge A / Length A
40-208-01	1	10 mm
40-208-02	2	12 mm
40-208-03	3	14 mm



Beckmann Ringmesser, mit Fangkorb, gerade, 22 cm
Beckmann adenoid curette, with basket, straight, 22 cm

	Größe / Size	Länge A / Length A
40-210-00	0	11 mm
40-210-01	1	13 mm
40-210-02	2	15 mm
40-210-03	3	17 mm
40-210-04	4	18 mm



Vogel Ringmesser, gerade, 21,5 cm
Vogel adenoid curette, straight, 21.5 cm

	Länge A / Length A
40-211-07	7 mm



**Jatho Nasenrachenzange,
70° aufgebogen, Rohrschaft,
15 cm Arbeitslänge**
Jatho epipharyngeal forceps,
70° upcurved, tubular model,
15 cm working length

40-220-01	vertikal öffnend / opens vertically
40-220-02	horizontal öffnend / opens horizontally



Jurasz Nasenrachenzange, 19 cm
Jurasz adenoid forceps, 19 cm

40-225-00



Adenotomy



St. Clair-Thomson Nasenrachenzange, 19 cm
St. Clair-Thomson adenoid forceps, 19 cm

40-226-00



Hartmann Conchotom, rund, 12 cm
Hartmann cutting forceps, round, 12 cm

	Größe / Size	
20-252-01	1 = 7 mm	
20-252-02	2 = 8 mm	
20-252-03	3 = 9 mm	
20-252-04	4 = 10 mm	



Schmeden Conchotom, dreieckig, 12 cm
Schmeden cutting forceps, triangular, 12 cm

	Größe / Size	
20-254-00	0 = 6 mm	
20-254-01	1 = 7 mm	
20-254-02	2 = 8 mm	
20-254-03	3 = 12 mm	



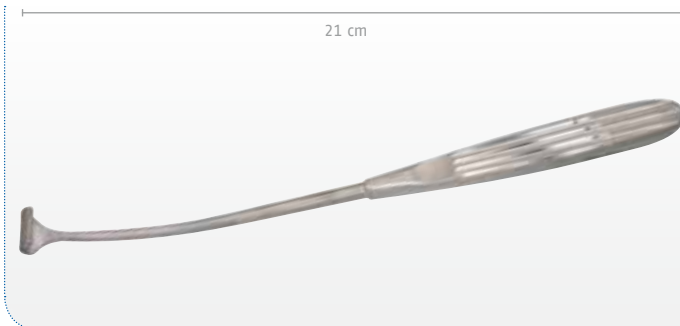

Nager Gaumensegelhaken, 21 cm
Nager pillar retractor, 21 cm

40-230-21



Hofer Gaumenbogenhaken, 23 cm
Hofer palate retractor, 23 cm

40-232-23

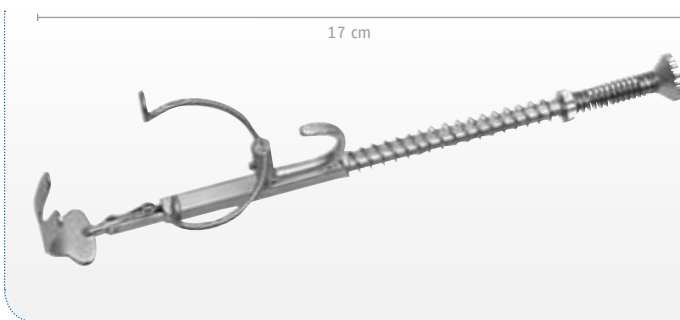

**Haslinger Gaumensegelhalter,
beweglich, 17 cm**
Haslinger uvula retractor,
movable, 17 cm

40-235-17

Adenotomy



Kabierske Pulverbläser, komplett mit drei Kanülen für Ohr, Nase, Rachen und Hals, mit Glas und Ventilball
 Kabierske powder blower, set with three cannulae for ear, nose, pharynx and larynx, bottle and rubber ball

- 10-155-00 Pulverbläser komplett / powder blower, set
- 10-155-01 Ersatzglas / spare bottle
- 10-155-02 Gummiball / rubber ball



Grünwald Zerstäuber-Set, je 1 gerader, aufwärts gebogener, abwärts gebogener Ansatz, 3 Glas Flakons, 1 Holz-Ständer
 Grünwald atomizer set, 1 straight, upcurved, downcurved cannula, 3 glass flacons, 1 wooden holder

- 40-248-00 Zerstäuber Set / atomizer set
- 40-248-10 Ersatzglas für Grünwald Zerstäuber / spare glass for Grünwald atomizer
- 40-249-00 Gummigebläse für Zerstäuber / rubber bulb for atomizer

40-249-00



**Davis-Meyer Mundsperrer,
verstellbare Zahnhaken**
Davis-Meyer mouth gag,
adjustable tooth hooks

40-300-01 rechts offen / right side open
40-300-02 links offen / left side open



Davis-Boyle Mundsperrer
Davis-Boyle mouth gag

40-302-01 rechts offen / right side open
40-302-02 links offen / left side open
40-302-03 rechts offen / right side open
für Kinder / for children
40-302-04 links offen / left side open
für Kinder / for children



Silikonschützer für Davis-Boyle Mundsperrer, 1 Stück
Silicone insert for Davis-Boyle mouth gags, 1 piece

40-303-00



Mclvor Mundsperrer, geschlossen
Mclvor mouth gag, closed form

40-305-00



**Silikonformschlauch, geschlitzt, für Mclvor
Mundsperrer, wiederverwendbar, 5 Stück**
Silicone tubing, slit, for Mclvor mouth gag,
re-useable, 5 pieces

40-305-99



Mclvor Mundsperrer, Drahtbügel mit Silikonchutz
Mclvor mouth gag,
wire frame with silicone protection

40-305-10

Tonsillectomy



Mclvor Zungenspatel, glatt
Mclvor tongue depressor, smooth

Größe / Size

40-310-01	1	(23 x 70 mm)
40-310-02	2	(25 x 86 mm)
40-310-03	3	(26 x 100 mm)



**Davis-Boyle Zungenspatel,
mit beidseitigem Absaugrohr**
Davis-Boyle tongue depressor,
double sided suction tubes

Größe / Size

40-311-01	1	(29,0 x 65 mm)
40-311-15	1½	(29,0 x 70 mm)
40-311-02	2	(30,5 x 75 mm)
40-311-25	2½	(31,5 x 80 mm)
40-311-03	3	(32,5 x 85 mm)
40-311-35	3½	(33,5 x 95 mm)
40-311-04	4	(34,0 x 105 mm)



Davis-Boyle Zungenspatel
Davis-Boyle tongue depressor

Größe / Size

40-312-01	1	(21 x 30 mm)	glatt / smooth
40-312-02	2	(23 x 65 mm)	gerieft / serrated
40-312-03	3	(24 x 80 mm)	gerieft / serrated
40-312-04	4	(25 x 93 mm)	gerieft / serrated
40-312-05	5	(26 x 108 mm)	gerieft / serrated

Für Kinder / for children

40-313-01	1	(17 x 30 mm)	glatt / smooth
40-313-02	2	(19 x 45 mm)	gerieft / serrated
40-313-03	3	(20 x 60 mm)	gerieft / serrated
40-313-04	4	(22 x 70 mm)	gerieft / serrated
40-313-05	5	(22 x 80 mm)	gerieft / serrated

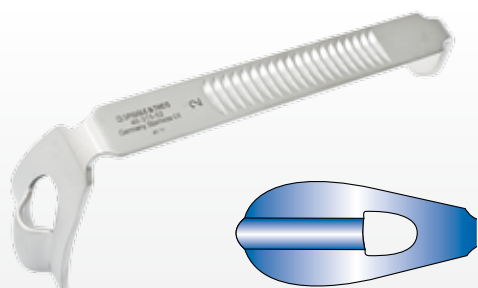

Russel-Davis Zungenspatel mit Rinne
Russel-Davis tongue depressor
with central channel

Größe / Size

40-315-01	1	(28 x 65 mm)
40-315-02	2	(32 x 75 mm)
40-315-03	3	(37 x 80 mm)
40-315-04	4	(41 x 94 mm)
40-315-05	5	(46 x 103 mm)

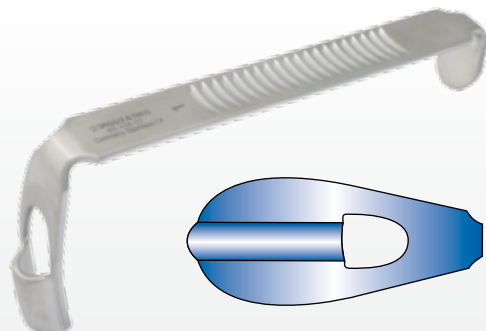

Russel-Davis Zungenspatel mit Rinne, schmales Modell
 Russel-Davis tongue depressor with central channel, slender model

Größe / Size

40-316-01	1	(18 x 55 mm)
40-316-02	2	(22 x 65 mm)
40-316-03	3	(27 x 70 mm)

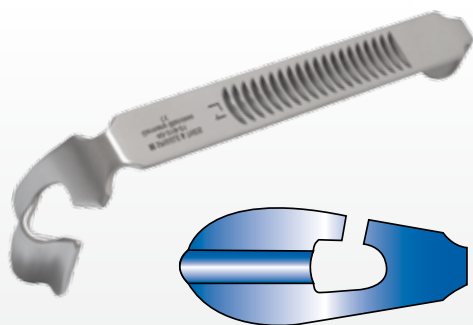

Russel-Davis Zungenspatel mit Rinne, Ausgang links
 Russel-Davis tongue depressor with central channel, outlet left side

Größe / Size

40-318-01	1	(28 x 65 mm)
40-318-02	2	(32 x 75 mm)
40-318-03	3	(37 x 80 mm)
40-318-04	4	(38 x 100 mm)
40-318-05	5	(46 x 108 mm)

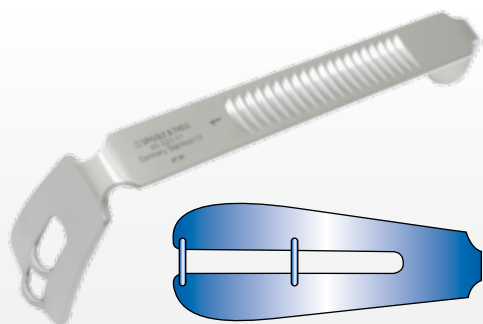

Zungenspatel, Würzburger Modell
 Tongue depressor, Würzburg model

Größe / Size

40-320-01	1	(28 x 67 mm)
40-320-02	2	(32 x 75 mm)
40-320-03	3	(34 x 83 mm)
40-320-04	4	(37 x 96 mm)
40-320-05	5	(38 x 103 mm)



Ring Zungenspatel
 Ring tongue depressor

Größe / Size

40-322-02	2	(23 x 58 mm)	links / left
40-322-03	3	(27 x 72 mm)	links / left
40-322-04	4	(34 x 87 mm)	links / left
40-322-05	5	(37 x 95 mm)	links / left
40-323-02	2	(23 x 58 mm)	rechts / right
40-323-03	3	(27 x 72 mm)	rechts / right
40-323-04	4	(34 x 87 mm)	rechts / right
40-323-05	5	(37 x 95 mm)	rechts / right

Tonsillectomy

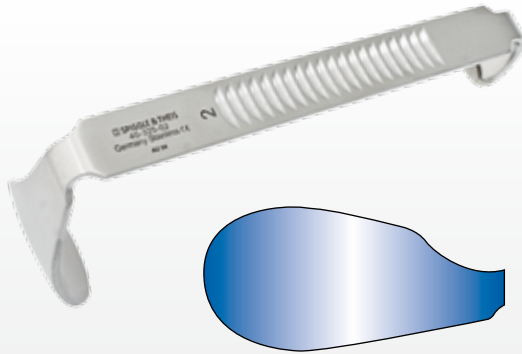

Herberhold Zungenspatel
Herberhold tongue depressor

Größe / Size

40-325-01	1	(28 x 63 mm)
40-325-02	2	(33 x 73 mm)
40-325-03	3	(37 x 82 mm)
40-325-04	4	(42 x 91 mm)



**Dingmann Mundsperrer,
Rahmen mit 2 Wangenhaltern,
2 Zahnhaken und 2 Fadenführer**
Dingmann mouth gag,
frame with 2 cheek retractors,
2 tooth hooks and 2 thread guide

40-327-00

Dingmann Wangenhaken, verstellbar, 2 Stück
Dingmann cheek retractors, adjustable, 2 pieces

40-327-98

Dingmann Zahnhaken, verstellbar, 2 Stück
Dingmann tooth hooks, adjustable, 2 pieces

40-327-99



Dingmann Zungenspatel
Dingmann tongue depressor

Größe / Size

40-327-01	1	(24 x 62 mm)
40-327-02	2	(28 x 65 mm)
40-327-03	3	(31 x 75 mm)

**Negus Bruststütze, mit Halteband**

Negus chest support, with band

40-330-14 14,0 cm, für Erwachsene / for adults
 40-330-09 8,5 cm, für Kinder / for children

Halteband für Negus Bruststützen

Band for Negus chest supports

40-330-99

**Driffin Mundsperrer-Aufhängung**

Driffin bipod suspension for mouth gags

40-335-00 für Erwachsene / for adults
 40-335-01 für Kinder / paediatric

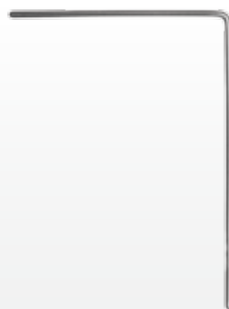
**Narkosebügel, L-Form,
zur Aufhängung von Mundsperrern**Anesthesia frame L-form,
for suspending mouth gags

40-337-00

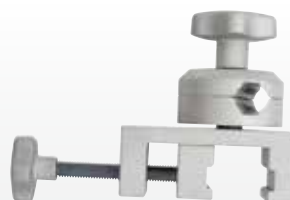
**Gelenkkloben zur Befestigung am OP-Tisch,
passend für flexiblen Spannarm 30-700-00
und Narkosebügel 40-337-00**Rotation clamp for fixation to operating table,
compatible with flexible holding arm 30-700-00
and anesthesia frame 40-337-00

30-700-01

**Kette zur Aufhängung der Mundsperrer
am Narkosebügel**Chain for mounting mouth gags
on anesthesia frame

40-338-00

Tonsillectomy

9 / 11 / 13 / 15 cm



Jennings Mundsperrer
Jennings mouth gag

40-340-09	9 cm
40-340-11	11 cm
40-340-13	13 cm
40-340-15	15 cm

11 / 13 cm



Seemann-Seiffert Mundsperrer, Standard-Modell
Seemann-Seiffert mouth gag, basic model

40-341-11	11 cm
40-341-13	13 cm

9 / 11 / 13 cm



Seemann-Seiffert Mundsperrer, selbsttätig nachspreizend
Seemann-Seiffert mouth gag, self retaining

40-342-09	9 cm
40-342-11	11 cm
40-342-13	13 cm



Sluder-Ballenger Tonsillotom, Simal-Ausführung, Handgriff
Sluder-Ballenger tonsillotome, simal model, handle

40-350-10

Sluder-Ballenger Tonsillotom Spatel, Simal-Ausführung
Sluder-Ballenger tonsillotome blade, simal model

40-350-00	0
40-350-01	1
40-350-02	2
40-350-03	3



**Brünings Tonsillenschnürer,
mit Feststellzähnen, 28 cm**
Brünings tonsil snare,
with ratchet, 28 cm

40-355-28

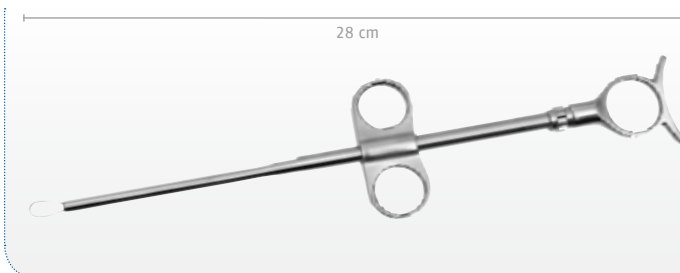

Eves Tonsillenschnürer, 28 cm
Eves tonsil snare, 28 cm

40-357-28



**Tonsillen-Schlingen,
rostfrei, geschlossen, 0,4 x 50 mm,
100 Stück/Box**
Tonsil wire loops,
stainless steel, closed, 0.4 x 50 mm,
100 pieces/box

40-360-50

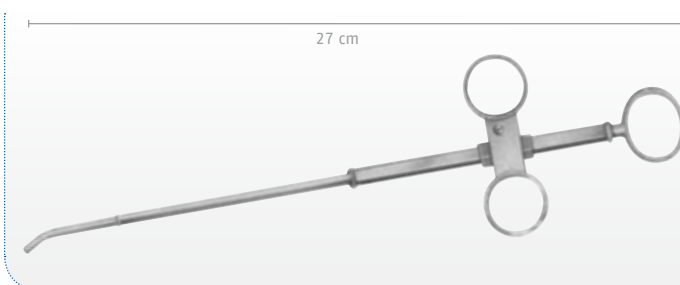

**Roeder Ligatur-Instrument,
Form E, für Vicryl-Faden, 27 cm**
Roeder ligature instrument,
form E, for vicryle wire, 27 cm

40-359-27



Tonsillectomy



Universal Drahtschneideschere, Hartmetall, 12 cm
Universal wire cutting scissors, tungsten carbide, 12 cm

10-745-12



Hurd Unterbindungsnadel, 22 cm
Hurd tonsil suture needle, 22 cm

40-365-01 rechts gebogen / right curved
40-365-02 links gebogen / left curved



Nager Unterbindungsnadel, gerade, 23,5 cm
Nager tonsil suture needle, straight, 23.5 cm

40-367-24



**Fadenhäkchen,
spitz, rund, 90°, 21,5 cm**
Suture hook,
pointed, round, 90°, 21.5 cm

40-368-21



**Fadenhäkchen,
stumpf, flach, 90°, 21,5 cm**
Suture hook,
blunt, flat, 90°, 21.5 cm

40-369-21



**Knotenführer,
gabelförmig, stumpf, 20,5 cm**
Knot tier,
forked, blunt, 20.5 cm

40-370-21

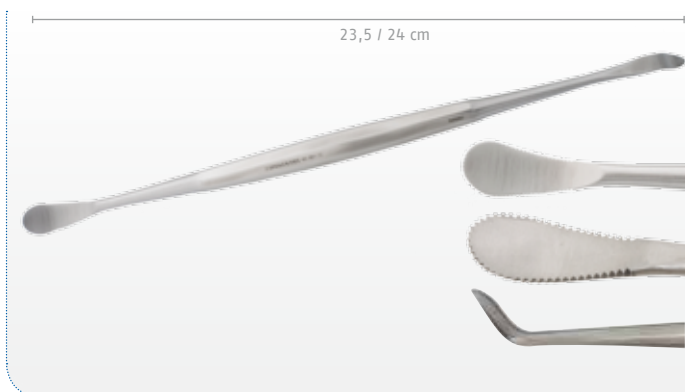

Henke Raspatorium/Dissektor
Henke raspatory/dissector

	Länge / Length		
40-381-12	23,5 cm	12 mm	schmal / slender
40-381-15	24,0 cm	15 mm	breit / wide



Tonsillectomy



**Henke Raspatorium,
doppelseitig, schmal/breit, 24 cm**
Henke raspatory,
double ended, slender/wide, 24 cm

40-382-24



**Stierlen Saugraspatorium,
13 mm, 23,5 cm**
Stierlen suction-raspatory,
13 mm, 23.5 cm

40-384-24



**Hurd Raspatorium/Retraktor,
10 mm/15 mm, 23 cm**
Hurd dissector/retractor,
10 mm/15 mm, 23 cm

40-385-23



**Hurd Elevatorium/Retraktor,
gefenstert, 11,5 mm, 23 cm**
Hurd elevator/retractor,
fenestrated, 11.5 mm, 23 cm

40-386-23



**Raspatorium Würzburger Modell,
eine Seite gezahnt, eine Seite Lanzett,
10 mm, 21,5 cm**
Raspatory Würzburg type,
one side serrated, one side lancet,
10 mm, 21.5 cm

40-388-21



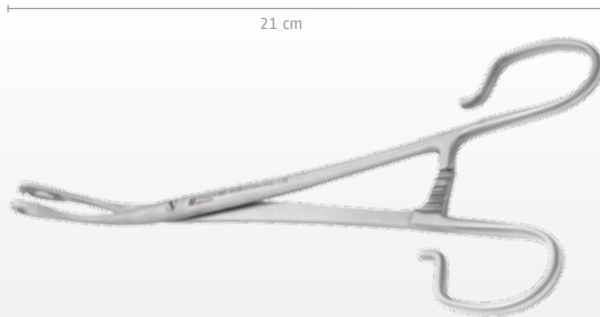

**Blohmke Fasszange,
gebogen, 21 cm**
Blohmke tonsil forceps,
curved, 21 cm

40-390-21



**Colver Fasszange,
gebogen, 19 cm**
Colver tonsil forceps,
curved, 19 cm

40-392-19



White Fasszange, gebogen
White tonsil forceps, curved

40-394-18 18 cm
40-394-23 23 cm

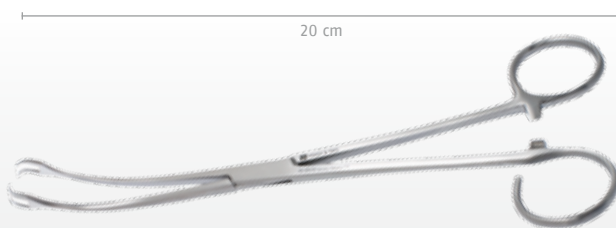

**Ballenger Fasszange,
gebogen, 2:2 Zähne, 20 cm**
Ballenger tonsil forceps,
curved, 2:2 teeth, 20 cm

40-395-22

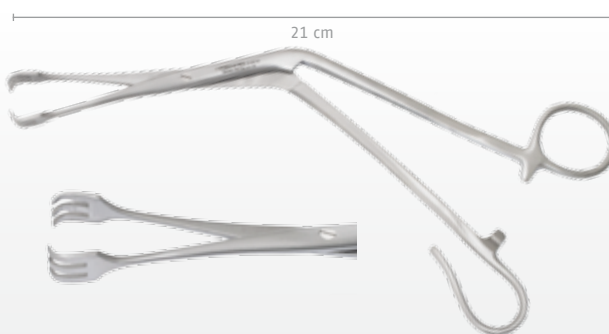

**Tyding Fasszange,
kniegebogen, 3:3 Zähne, 21 cm**
Tyding tonsil forceps,
angled, 3:3 teeth, 21 cm

40-397-21

Tonsillectomy

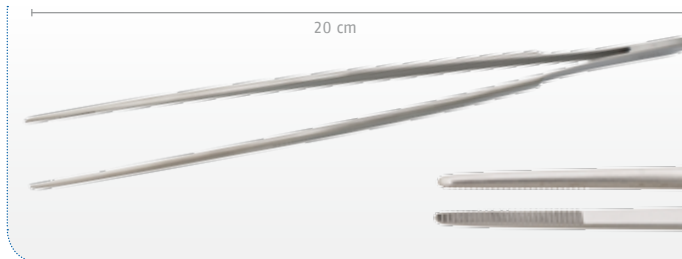

**Tonsillen-Pinzette,
gerieft, fein, 2,2 mm, 20 cm**
Tonsil dressing forceps,
serrated, fine, 2.2 mm, 20 cm

40-400-20



**Tonsillen-Pinzette,
gerieft, breit, 3 mm, 20 cm**
Tonsil dressing forceps,
serrated, wide, 3 mm, 20 cm

40-401-20



**Tonsillen-Pinzette,
gerieft, Hartmetall, fein, 2 mm, 20 cm**
Tonsil dressing forceps,
serrated, tungsten carbide, fine, 2 mm, 20 cm

40-402-20

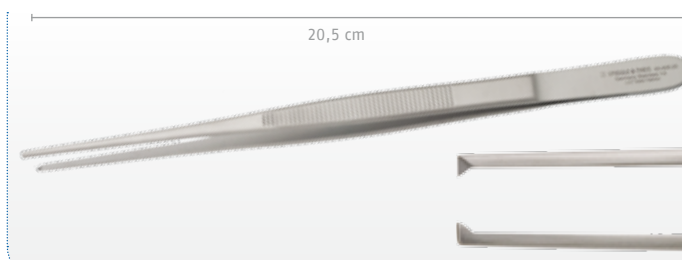

**Tonsillen-Pinzette,
1:2 Zähne, fein, 2 mm, 20,5 cm**
Tonsil dissecting forceps,
1:2 teeth, fine, 2 mm, 20.5 cm

40-405-20

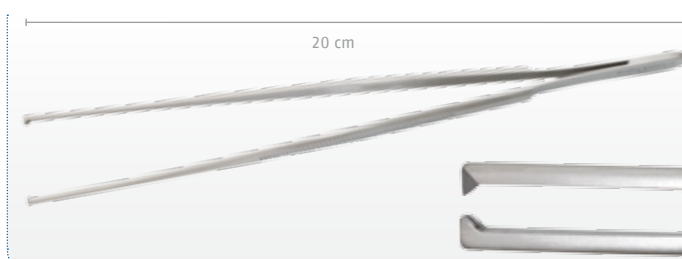

Tonsillen-Pinzette, breit, 20 cm
Tonsil dissecting forceps, wide, 20 cm

- 40-406-20 1:2 Zähne / teeth 3,0 mm
- 40-407-20 2:3 Zähne / teeth 3,5 mm
- 40-408-20 3:4 Zähne / teeth 5,5 mm



**DeBakey Pinzette,
atraumatisch, 20 cm**
DeBakey dressing forceps,
atraumatic, 20 cm

- 40-410-20 2,7 mm
- 40-412-20 2,0 mm



**Yankauer Saugrohr
mit Olive und Aufsatz, 2 mm**
Yankauer Suction tube
with olive and tip, 2 mm

- 40-420-29 27 cm, für Erwachsene /
for adults
- 40-421-21 21 cm, für Kinder /
for children



**Saugrohr,
gerade, konisch, biegsam, 3 mm, 17,5 cm**
Suction tube,
straight, conical, flexible, 3 mm, 17.5 cm

10-303-18

Tonsillectomy



Good-Schweckendiek Tonsillenschere, gebogen, gezahnt, 19 cm
Good-Schweckendiek tonsil scissors, curved, serrated, 19 cm

40-430-19



Good Tonsillenschere, gebogen, glatt, 19 cm
Good tonsil scissors, curved, smooth, 19 cm

40-431-19



Boettcher Tonsillenschere, gebogen, 19 cm
Boettcher tonsil scissors, curved, 19 cm

40-433-18 stumpf / blunt
40-434-18 spitz / pointed

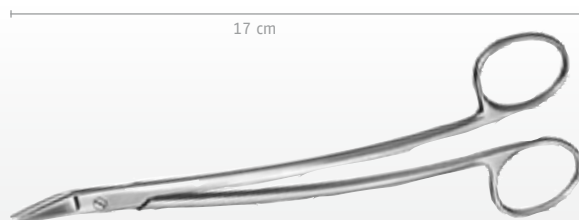

Dean Tonsillenschere, doppelt gebogen, gezahnt, spitz, 17 cm
Dean tonsil scissors, double curved, serrated, pointed, 17 cm

40-436-17

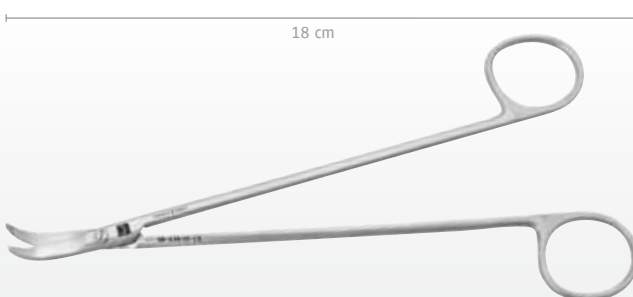

Muck Tonsillenschere, stark gebogen, 18 cm
Muck tonsil scissors, strongly curved, 18 cm

40-438-18



**Toennis-Adson Tonsillenschere,
gebogen, stumpf, extra fein, 17,5 cm**
Toennis-Adson tonsil scissors,
curved, blunt, very fine, 17.5 cm

40-440-18



**Toennis-Adson Tonsillenschere,
supercut, gebogen, stumpf, extra fein, 17,5 cm**
Toennis-Adson tonsil scissors,
supercut, curved, blunt, very fine, 17.5 cm

40-441-18



**Toennis-Adson Tonsillenschere,
Hartmetall, supercut, gebogen, stumpf,
extra fein, 17,5 cm**
Toennis-Adson tonsil scissors,
tungsten carbide, supercut, curved,
blunt, very fine, 17.5 cm

40-442-18



**Metzenbaum Schere,
gerade, stumpf-stumpf**
Metzenbaum scissors,
straight, blunt

20-612-18 18 cm
20-612-20 20 cm

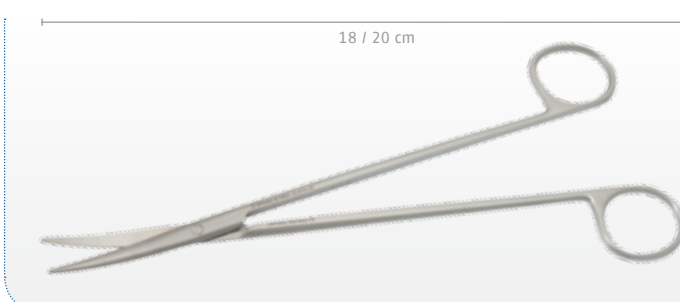

**Metzenbaum Schere,
gebogen, stumpf-stumpf, fein**
Metzenbaum scissors,
curved, blunt, fine

20-614-18 18 cm
20-614-20 20 cm



Tonsillectomy



**Metzenbaum Schere,
Hartmetall, gerade, stumpf-stumpf, fein**
Metzenbaum scissors,
tungsten carbide, straight, blunt, fine

20-613-18 18 cm
20-613-20 20 cm



**Metzenbaum Schere,
Hartmetall, gebogen, stumpf-stumpf, fein**
Metzenbaum scissors,
tungsten carbide, curved, blunt, fine

20-615-18 18 cm
20-615-20 20 cm



**Metzenbaum Schere,
supercut, gebogen, stumpf-stumpf, fein, 18 cm**
Metzenbaum scissors,
supercut, curved, blunt, fine, 18 cm

20-616-18



**Schneid Tonsillenklemme,
einseitig offener Ring, schlank, 19 cm**
Schneid tonsil forceps,
one ring open, slender, 19 cm

40-450-19 leicht gebogen / slightly curved
40-451-19 stark gebogen / strongly curved





Birkett Tonsillenklemme, schlank, 20 cm
Birkett tonsil forceps, slender, 20 cm

- 40-454-20 gerade / straight
- 40-455-20 gebogen / curved

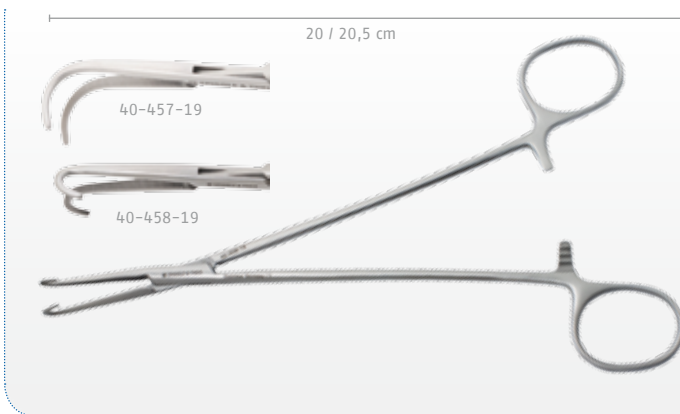

Negus Tonsillenklemme, schlank
Negus tonsil forceps, slender

- 40-457-19 weiter Bogen, 20 cm / wide curve
- 40-458-19 enger Bogen, 20,5 cm / narrow curve



Overholt-Geissdoerfer Tonsillenklemme, gebogen, 19 cm
Overholt-Geissdoerfer tonsil forceps, curved, 19 cm

- 40-460-19

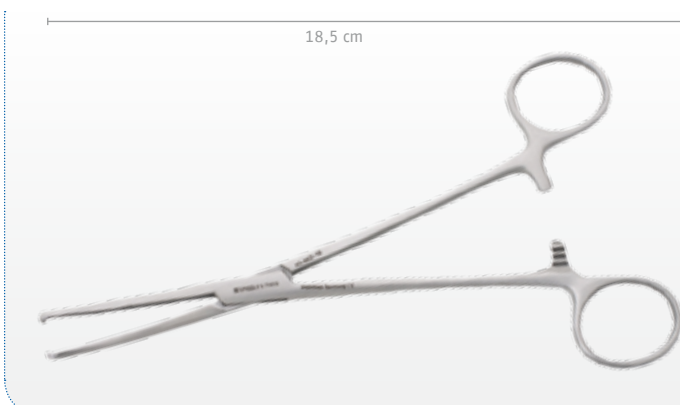

Mikulicz Tonsillenklemme, gebogen, 1:2 Zähne, 18,5 cm
Mikulicz tonsil forceps, curved, 1:2 teeth, 18.5 cm

- 40-462-18



Tonsillectomy



**Crile-Wood Nadelhalter,
Hartmetall, schlank**
Crile-Wood needle holder,
tungsten carbide, slender

- 40-465-18 18 cm
- 40-465-20 20 cm
- 40-465-23 23 cm



**Duplay Tupferzange,
fein, gebogen, 17,5 cm**
Duplay sponge forceps,
fine, curved, 17.5 cm

40-470-18

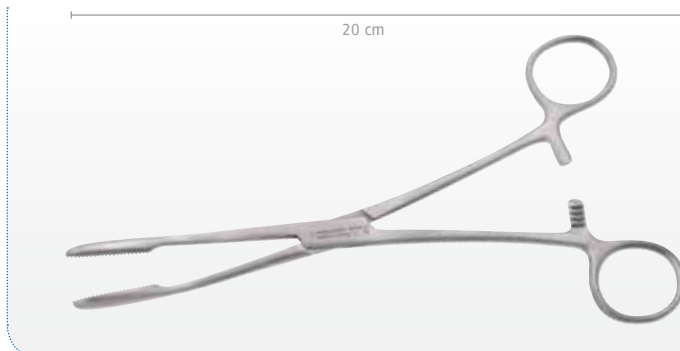

**Gross Kornzange,
gebogen, 20 cm**
Gross sponge forceps,
curved, 20 cm

40-474-20

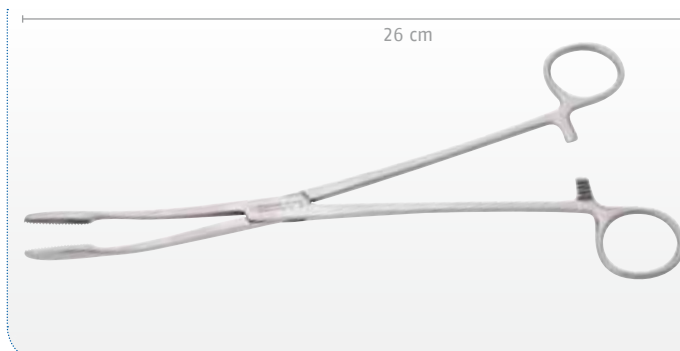

**Gross-Maier Kornzange,
gebogen, 26 cm**
Gross-Maier sponge forceps,
curved, 26 cm

40-475-26



**Thilenius Tonsillen-Abszess-Zange,
gebogen, 20 cm**
Thilenius tonsil abscess forceps,
curved, 20 cm

40-477-20





**Abraham Tonsillennmesser,
spitz, gebogen, 22 cm**
Abraham tonsil knife,
pointed, curved, 22 cm

40-480-22



**Brünings Tonsillennmesser,
spitz, gebogen, 23 cm**
Brünings tonsil knife,
pointed, curved, 23 cm

40-482-23



**Colver-Fischer Tonsillennmesser,
gewinkelt, gezahnt, 22 cm**
Colver-Fischer tonsil knife,
angled, serrated, 22 cm

40-484-22



Skalpell-Griff
Scalpel handle

Größe / Size

10-360-03	Nr. / No. 3	12,0 cm
10-360-04	Nr. / No. 4	13,5 cm
10-360-07	Nr. / No. 7	16,0 cm
10-360-33	Nr. / No. 3L	21,0 cm

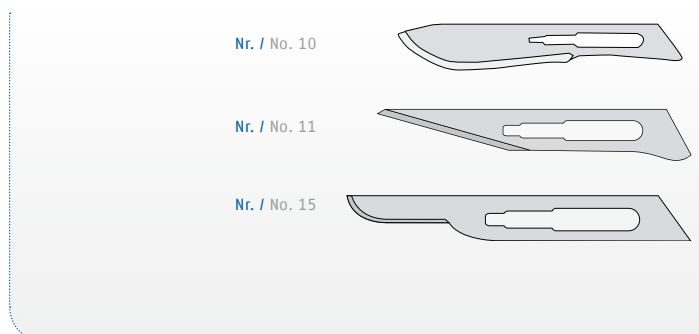

**Skalpell-Klingen,
einzeln steril gepackt, 100 Stück**
Scalpel blades,
single sterile packed, 100 pieces

Größe / Size

10-360-10	Nr. / No. 10	
10-360-11	Nr. / No. 11	spitz / pointed
10-360-15	Nr. / No. 15	gerundet / rounded

Larynx



**Brünings Zungenspatel,
gefenstert, 19 cm**
Brünings tongue depressor,
fenestrated, 19 cm

40-500-19



Frenzel Zungenspatel, 16,5 cm
Frenzel tongue depressor, 16.5 cm

40-502-17



**Buchwald Zungenspatel,
19/23 mm, 18 cm**
Buchwald tongue depressor,
19/23 mm, 18 cm

40-508-18



**Moritz-Schmidt Zungenspatel,
gefenstert, 19 cm**
Moritz-Schmidt tongue depressor,
fenestrated, 19 cm

40-506-19



**Hartmann Zungenspatel,
gewinkelt, 15 cm**
Hartmann tongue depressor,
angled, 15 cm

40-504-15



Tapia Adenoid Spatel, 15 cm
Tapia adenoid spatula, 15 cm

- 40-510-01 9 Löcher / 9 holes
- 40-510-02 12 Löcher / 12 holes
- 40-510-03 15 Löcher / 15 holes



Kehlkopfspiegel mit festem Sechskantgriff
Laryngeal mirror with fixed hexagonal handle

	Größe / Size		∅
40-526-30	000		6 mm
40-526-20	00		8 mm
40-526-00	0		10 mm
40-526-01	1		12 mm
40-526-02	2		14 mm
40-526-03	3		16 mm
40-526-04	4		18 mm
40-526-05	5		20 mm
40-526-06	6		22 mm
40-526-07	7		24 mm
40-526-08	8		26 mm
40-526-09	9		28 mm
40-526-10	10		30 mm



Kehlkopfspiegel ohne Griff, ohne Gewinde
Laryngeal mirror without handle, without screw

	Größe / Size		∅
40-522-30	000		6 mm
40-522-20	00		8 mm
40-522-00	0		10 mm
40-522-01	1		12 mm
40-522-02	2		14 mm
40-522-03	3		16 mm
40-522-04	4		18 mm
40-522-05	5		20 mm
40-522-06	6		22 mm
40-522-07	7		24 mm
40-522-08	8		26 mm
40-522-09	9		28 mm
40-522-10	10		30 mm

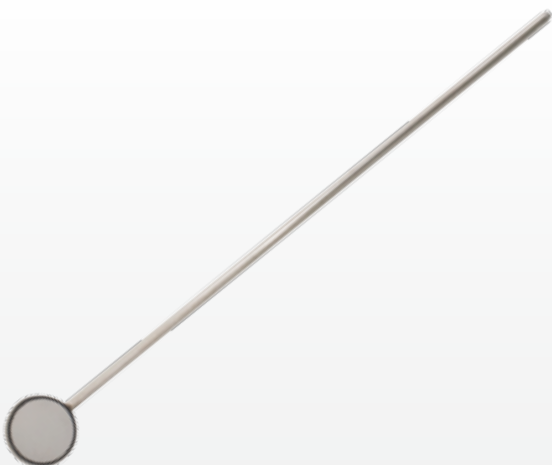

**Kehlkopfspiegel, Rhodium beschichtet,
ohne Griff, ohne Gewinde**
Laryngeal mirror, rhodium coated,
without handle, without screw

	Größe / Size		∅
40-524-30	000		6 mm
40-524-20	00		8 mm
40-524-00	0		10 mm
40-524-01	1		12 mm
40-524-02	2		14 mm
40-524-03	3		16 mm
40-524-04	4		18 mm
40-524-05	5		20 mm
40-524-06	6		22 mm
40-524-07	7		24 mm
40-524-08	8		26 mm
40-524-09	9		28 mm
40-524-10	10		30 mm

Larynx



**Griff für Kehlkopfspiegel,
Zentralverschraubung, 11 cm**
Handle for laryngeal mirrors,
central screw, 11 cm

40-520-00



Metall-Spritze mit Glaszylinder, Luer-Lock
Metal syringe with glass tube, Luer-Lock

- 40-550-02 2 ccm
- 40-550-05 5 ccm
- 40-550-10 10 ccm

Ersatzglas für Metall-Spritze
Spare glass for metal syringe

- 40-551-02 2 ccm
- 40-551-05 5 ccm
- 40-551-10 10 ccm

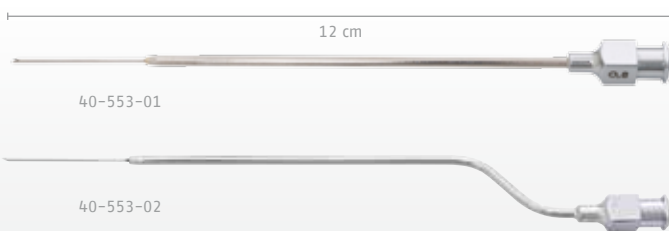

**Injektionskanüle,
0,8 mm, 12 cm, Luer-Lock**
Injection needle,
0.8 mm, 12 cm, Luer-Lock

- 40-553-01 gerade / straight
- 40-553-02 bajonett / bayonet



**Kehlkopf-Kanüle,
gebogen, Luer-Lock, 2,0 mm, 13 cm**
Laryngeal cannula,
curved, Luer-Lock, 2.0 mm, 13 cm

40-555-13



**Reichert Epiglottis Halter,
gebogen, 24 cm**
Reichert epiglottis holder,
curved, 24 cm

40-558-24



Pelteson Kehlkopfwatteträger, gewinkelt, 2-Ring, 21,5 cm
Pelteson laryngeal cotton carrier, angled, 2 rings, 21.5 cm

40-560-22

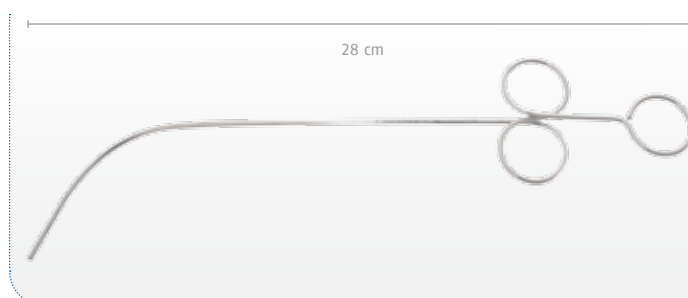

Fein Kehlkopfwatteträger, gebogen, 3-Ring, 28 cm
Fein laryngeal cotton carrier, curved, 3 rings, 28 cm

40-561-28



Kilian Kehlkopfwatteträger, gebogen, Massivgriff, 25 cm
Kilian laryngeal cotton carrier, curved, solid handle, 25 cm

40-563-25

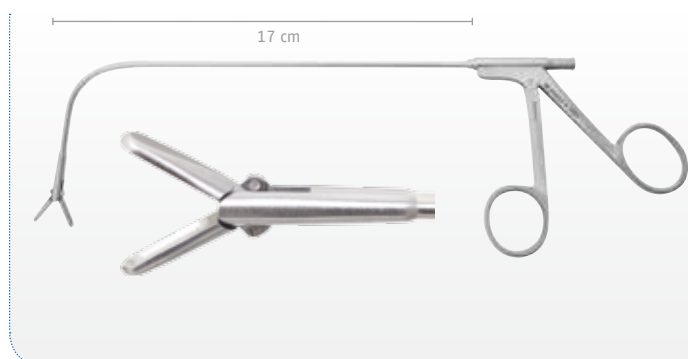

Kehlkopzfange, Rohrschaft, gebogen, ovale Löffel, Spülkanal, Arbeitslänge 17 cm
Laryngeal forceps, tubular model, curved, oval cups, irrigation channel, working length 17 cm

40-570-01 vertikal / vertical
40-570-02 horizontal / horizontal

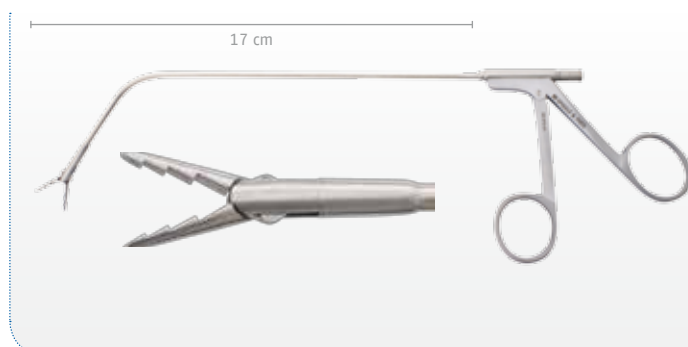

Kehlkopzfange, Rohrschaft, gebogen, Hechtmaul, Spülkanal, Arbeitslänge 17 cm
Laryngeal forceps, tubular model, curved, alligator, irrigation channel, working length 17 cm

40-572-01 vertikal / vertical
40-572-02 horizontal / horizontal

Larynx



Huber Universal Handgriff, Standard
Huber universal handle, standard

40-575-00

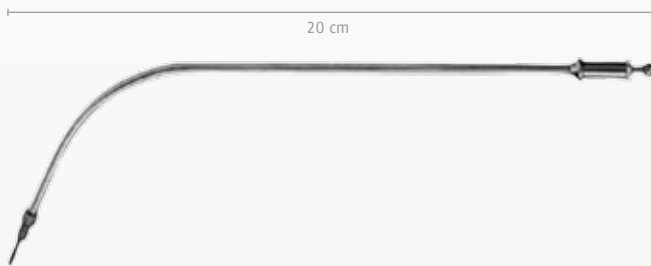

Ansatzrohr, gebogen, 20 cm
Connecting tube, curved, 20 cm

40-576-20



**Brünings Löffelansatz,
rund, 3 mm**
Brünings tip,
round cups, 3 mm

40-578-00 gerade / straight
40-579-00 nach oben gebogen /
curved upwards



Seiffert Hechtmaulansatz, gerade
Seiffert alligator tip, straight

40-580-00



**Fraenkel Löffelansatz,
oval, gerade, 10 x 4,5 mm**
Fraenkel tip,
oval cups, straight, 10 x 4.5 mm

40-581-00



Salivary Duct



PD Dr. med. Urban Geisthoff
HNO-Klinik
Universitätsklinik Essen

Dr. med. Urban Geisthoff M.D.
ENT Clinic
University Clinic, Essen

Sialoskope nach Geisthoff

Die technischen Eigenschaften machen dieses Sialendoskop zu einem vielseitigen Instrument für diagnostische und interventionelle Eingriffe:

Der großlumige Arbeitskanal erlaubt den Einsatz von Instrumenten mit einem Außendurchmesser von bis zu 1 mm bei gleichzeitig relativ geringem Außendurchmesser von 1,7 mm. So können z.B. Zängchen, Ballons, Laserfasern und Körbchen zur Behandlung der Sialolithiasis oder von Gangstenosen eingesetzt werden. 6000 Fasern sorgen für eine exzellente Sicht. Das Sialendoskop ist autoklavierbar.

Geisthoff therapeutic sialendoscopes

The technical properties make these sialendoscopes versatile instruments for both diagnostic and interventional treatment: The generous working channel has a relatively small outer diameter of 1.7mm, yet allows the use of instruments with an outer diameter of up to 1 mm. Forceps, balloons laser fibres and baskets can be inserted and used in the treatment of sialolithiasis and dilation of stenoses. Excellent visibility is assured by 6000 laser fibres. The sialendoscopes are autoclavable.



Fig. 1
Gl. submandibularis:
Normaler Wharton-
scher Gang

Submandibular
gland: Normal
Wharton's duct



Fig. 2
Gl. submandibularis: Normaler Hilusbereich

Submandibular
gland: Normal
hilum region



Fig. 3
Gl. submandibularis:
Stein mit schleier-
artigem organischen
Anteil hinter der ers-
ten Gangaufzweigung

Submandibular
gland:
Stone with surround-
ing organic material
directly behind the first
bifurcation



Fig. 4
Gl. submandibularis: Geschlossenes Zängelchen vor o.g. Stein

Submandibular
gland: Closed forceps
in front
of the stone from
figure 3



Fig. 5
Gl. submandibularis: Öffnen des Zängelchens

Submandibular
gland: Opening of
the forceps



Fig. 6
Gl. submandibularis: Zugreifen

Submandibular
gland:
Grasping of the
stone



Fig. 7
Gl. parotis:
Leicht entzünd-
lich veränderter
Stensen'scher
Gang

Parotid gland:
Slightly inflamed
Stensen's duct



Fig. 8
Gl. parotis:
Normale Gangauf-
zweigung

Parotid gland:
Normal bifurcation



Fig. 9
Gl. parotis:
Stein hinter einer
Aufzweigung zweiten
Grades

Parotid gland:
Stone behind a second
generation bifurcation



Fig. 10
Gl. parotis:
Einführen des Zäng-
chens (im Bild links
oben zu erkennen)

Parotid gland: Insertion
of a forceps (upper left
corner of the picture)



Fig. 11
Gl. parotis:
Weiteres Einführen des
Zängelchens vor dem
Fassen des Steines

Parotid gland:
Further insertion of
the forceps just before
grasping of the stone



Fig. 12
Bloße Faser von einem
Ho: YAG Laser auf einem
teilweise zersplitterten
Stein innerhalb der
submandibular Drüse

Bare fiber of a Ho:YAG
laser on a partially frag-
mented stone inside the
submandibular gland



Fig. 13
Papilla des Whartonschen
Gangs: Eine Zange ist
bereits in das Gangsys-
tem eingeführt worden.
Jetzt kann das Endoskop
der Zange wie einem
Führungsdraht folgen.

Papilla of Wharton's
duct: A forceps has already
been introduced into
the duct system. Now the
endoscope can follow
by using the forceps as
guide wire.



Sialoskope nach Geisthoff / Geisthoff therapeutic sialendoscopes

Für diagnostische/endoskopische Untersuchung und Therapie des Speichelkanals
Mit integriertem Spülkanal und/oder Arbeitskanal

For diagnostic/endoscopic inspection and therapy of the salivary duct
With integrated irrigation channel and/or working channel

- Kombination aus klinischem Komfort und hoher Abbildungsqualität
 - Gute diagnostische und therapeutische Optionen mit geringen Unannehmlichkeiten für den Patienten
 - Vervollständigt das diagnostische Spektrum für Speicheldrüsenerkrankungen
 - Luer-Lock-Verbindung für die Arbeitskanäle
-
- Combining clinical convenience with high quality imaging
 - Good diagnostic and therapeutic options with little discomfort for the patients
 - Completes the diagnostic spectrum for salivary gland disorders
 - Luer-Lock connection for working channels



- Autoklavierbar
 - Inklusive Handstück
 - Integrierte Faseroptik
 - Blickwinkel: 70°
-
- Autoclavable
 - Handpiece included
 - Integrated fiber optic
 - Field of view: 70°

Art.-Nr. / Art.-No.	Beschreibung / Description	Typ / Type	AD / OD	Pixel	Spülkanal / Irrigation Channel	Arbeitskanal / Working Channel
80-800-09	starr / rigid	Type 1	0,9 mm	6000	/	0,26 mm
80-801-10	starr / rigid	Type 2	1,0 mm	6000	∅ = 0,20 mm	0,41 mm
80-802-12	starr / rigid	Type 3	1,2 mm	6000	∅ = 0,20 mm	0,62 mm
80-803-17	starr / rigid	Type 4	1,7 mm	6000	∅ = 0,20 mm	1,02 mm
80-805-13	flexibel / flexible	Type 5	1,3 mm	6000	/	0,35 mm

Salivary Duct

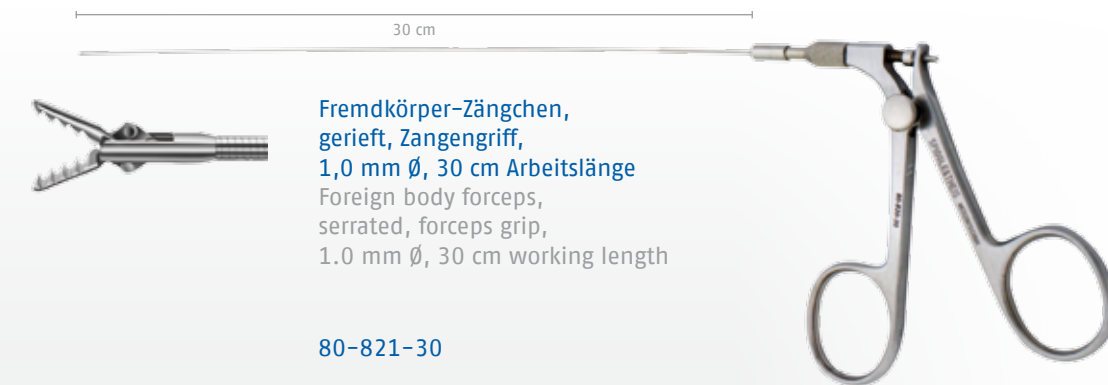



**Reinigungs-Set zum Durchstoßen
verstopfter Arbeitskanäle > 0,25 mm Ø,
30 mcm Arbeitslänge, 10 Stück**
Cleaning set for clogged working channels
> 0.25 mm Ø, 30 cm working length,
10 pieces

80-841-30

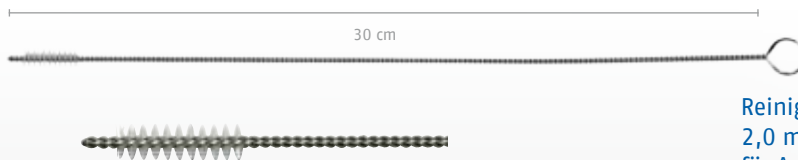

**Reinigungsbürste mit Grifföse,
2,0 mm Ø, Besatz 10 mm,
für Arbeitskanäle < 1,5 mm Ø,
30 cm Arbeitslänge, 10 Stück**
Cleaning brush with loop handle,
2.0 mm Ø, bristle area 10 mm,
for working channels < 1.5 mm Ø,
30 cm working length, 10 pieces

80-844-30

Salivary Duct



HN0-Spülkorb, 48 x 25 x 4 cm, Edelstahl mit abnehmbarem Deckel, Kleinteilekorb und Instrumentenaufnahmen, e-polier
 ENT instrument tray, 48 x 25 x 4 cm, stainless steel with removable lid, small parts basket and instrument holders, e-polished

80-695-00



Norm-Sterilisations-Container, Normalboden, Ventildeckel mit Thermolock, Aluminium, Griff-Farbe nach Wahl, 59,6 x 27,5 x 14 cm
 Norm sterilization container, unperforated bottom, valve lid with thermolock, aluminium, handle in any colour, 59.6 x 27.5 x 14 cm

80-660-14



Speichelgang-Schere, gewinkelt, 11,5 cm
 Salivary duct scissors, angled, 11.5 cm

40-600-12 mit Knopf / with ball end
 40-601-12 ohne Knopf / without ball end

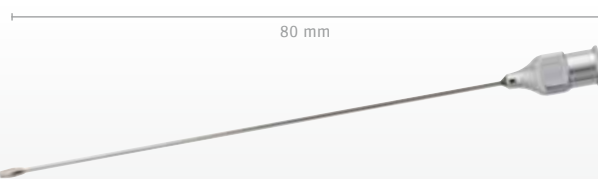

Knopfkanüle, gerade, Luer-Lock, unsteril
 Cannula ball-ended, straight, Luer-lock, non-sterile

40-604-08 0,8 x 80 mm
 40-604-10 1,0 x 80 mm
 40-604-12 1,2 x 80 mm



Bangerter Tränenwegkanüle, stumpf, seitliche Öffnung, gerade, Luer-Lock
 Bangerter lacrimal duct cannula, blunt, lateral opening, straight, Luer-lock

40-606-06 0,6 x 60 mm
 40-606-08 0,8 x 60 mm

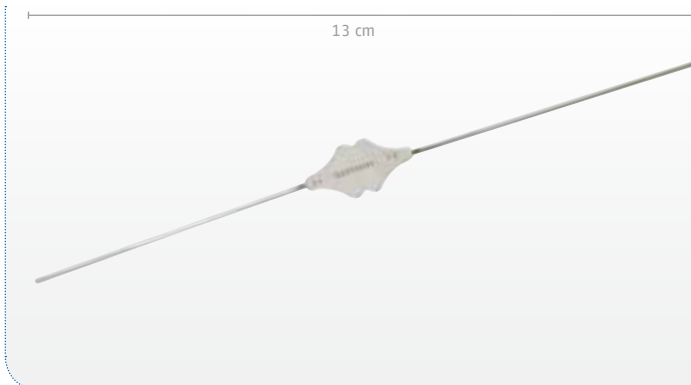

Bowman Speichelgangsonde,
Neusilber, gerade, zylindrisch, 13 cm
Bowman salivary duct probe,
alpaca, straight, cylindrical, 13 cm

	Ø	Größe / Size
40-610-40	0,6/0,7 mm	(0000/000)
40-610-20	0,8/0,9 mm	(00/0)
40-610-12	1,0/1,2 mm	(1/2)
40-610-34	1,3/1,4 mm	(3/4)



Ruedemann Dilator für Kleinkinder, 8 cm
Ruedemann dilator for infants, 8 cm

40-613-08



Wilder Dilator, 11 cm
Wilder dilator, 11 cm

	Größe / Size
40-615-01	1
40-615-02	2
40-615-03	3

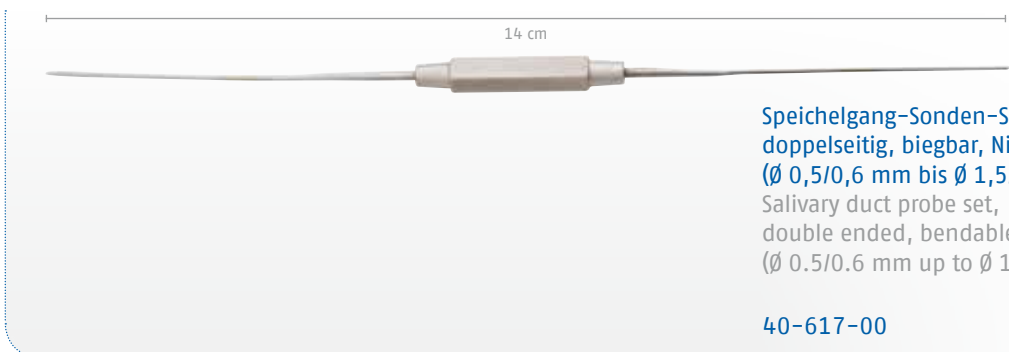

Speichelgang-Sonden-Set,
doppelseitig, biegsam, Nitinol, 6 Größen
(Ø 0,5/0,6 mm bis Ø 1,5/1,6 mm), 14 cm
Salivary duct probe set,
double ended, bendable, Nitinol, 6 sizes
(Ø 0.5/0.6 mm up to Ø 1.5/1.6 mm), 14 cm

40-617-00

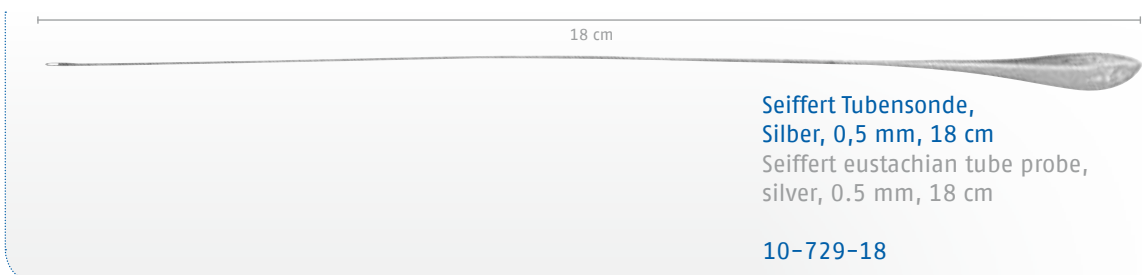

Seiffert Tubensonde,
Silber, 0,5 mm, 18 cm
Seiffert eustachian tube probe,
silver, 0.5 mm, 18 cm

10-729-18

Coagulation



HF-Chirurgie-Gerät MD3,
 80 Watt bipolar/80 Watt monopolar schneiden,
 80 Watt monopolar koagulieren, Netzkabel
 HF surgery unit MD3,
 80 Watt bipolar/80 Watt unipolar cutting,
 80 Watt monopolar coagulation, power cable

80-000-80



Einpedal-Fußschalter
 für HF-Chirurgie-Gerät MD3
 Single pedal foot switch
 for HF-surgical-unit MD3

80-003-01 Praxisversion /
 Medical practice version
 80-003-02 OP-Version / OR-version



Elektroden-Handgriff,
 monopolar, ohne Schalter,
 für 4 mm Elektroden, autoklavierbar
 Electrode handle,
 monopolar, without switch,
 for 4 mm electrodes, autoclavable

80-004-00



Elektroden-Handgriff,
 monopolar, mit Schalter,
 für 4 mm Elektroden, autoklavierbar
 Electrode handle,
 monopolar, with switch,
 for 4 mm electrodes, autoclavable

80-005-00

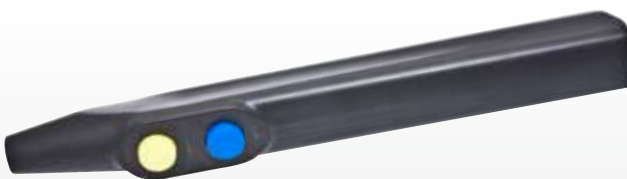

Elektroden-Handgriff,
 monopolar, mit 2 Schaltern,
 für 4 mm Elektroden, autoklavierbar
 Electrode handle,
 monopolar, with 2 switches,
 for 4 mm electrodes, autoclavable

80-006-00



Silikon Neutral-Elektrode,
8 x 15 cm, 4 m Kabel, passend für
Micromed/Martin/Berchthold/Aesculap
Silicone neutral electrode,
8 x 15 cm, 4 m cable, fitting to
Micromed/Martin/Berchthold/Aesculap

80-010-40



Silikon Neutral-Elektrode,
17 x 30 cm, 4 m Kabel, passend für
Micromed/Martin/Berchthold/Aesculap
Silicone neutral electrode,
17 x 30 cm, 4 m cable, fitting to
Micromed/Martin/Berchthold/Aesculap

80-011-40



Halteband für Neutralelektrode,
Gummi, 75 cm
Holding band for neutral electrode,
rubber, 75 cm

80-012-75



Kabel für Einmal-Neutral-Elektrode,
4,0 m, passend für Micromed/Martin/
Erbe/Berchthold/Aesculap
Cable for single use neutral electrode,
4.0 m, compatible with Micromed/Martin/
Erbe/Berchthold/Aesculap

80-013-40

Coagulation



Monopolares Anschlusskabel für Spiggle & Theis Elektroden-Handgriffe 4,5 m, passend für Sutter/Martin/Berchtold/Aesculap, autoklavierbar
 Monopolar connecting cable for Spiggle & Theis electrode handles, 4.5 m, compatible with Sutter/Martin/Berchtold/Aesculap, autoclavable

80-007-45



Monopolares Anschlusskabel für Spiggle & Theis Elektroden-Handgriffe 4,5 m, passend für Erbe ICC/ACC, Wolf/Storz, autoklavierbar
 Monopolar connecting cable for Spiggle & Theis electrode handles, 4.5 m, compatible with Erbe ICC/ACC, Wolf/Storz, autoclavable

80-008-45



Monopolares Anschlusskabel für Erbe Elektroden-Handgriffe 4,5 m, passend für Erbe ICC/ACC, Wolf/Storz, autoklavierbar
 Monopolar connecting cable for Erbe electrode handles, 4.5 m, compatible with Erbe ICC/ACC, Wolf/Storz, autoclavable

80-009-45



Monopolares Anschlusskabel für Instrumente, 4 mm, 4,5 m, passend für Sutter/Martin/Berchtold/Aesculap, autoklavierbar
 Monopolar connecting cable for instruments, 4 mm, 4.5 m, compatible with Sutter/Martin/Berchtold/Aesculap, autoclavable

80-014-45



Monopolares Anschlusskabel für Instrumente, 4 mm, 4,5 m, passend für Erbe ICC/ACC, Wolf/Storz, autoklavierbar
 Monopolar connecting cable for instruments, 4 mm, 4.5 m, compatible with Erbe ICC/ACC, Wolf/Storz, autoclavable

80-015-45



**Monopolares Anschlusskabel für Instrumente,
4 mm, 4,5 m**

Monopolar connecting cable for instruments,
4 mm, 4.5 m

80-045-15 **passend für Valleylab /**
compatible with Valleylab

80-046-45 **passend für Covidien /**
compatible with Covidien



**Bipolares Anschlusskabel für Instrumente,
Olympus/Söring/Coa/Erbe-Vio Intl.,
autoklavierbar**

Bipolar connecting cable for instruments,
Olympus/Söring/Coa/Erbe-Vio Intl.,
autoclavable

80-016-30 3 m

80-016-50 5 m



**Bipolares Anschlusskabel,
passend für Sutter/Martin/Berchtold/Aesculap/
Integra/Spiggle & Theis**

Bipolar connecting cable,
compatible with Sutter/Martin/Berchtold/
Aesculap/Integra/Spiggle & Theis

80-017-30 3 m

80-017-50 5 m



**Bipolares Anschlusskabel,
passend für Erbe/Storz/Wolf**

Bipolar connecting cable,
compatible with Erbe/Storz/Wolf

80-018-30 3 m

80-018-50 5 m



**Bipolares Anschlusskabel,
passend für Valleylab/Lamidey/Bowa/EMC**

Bipolar coagulation cable,
compatible with Valleylab/Lamidey/Bowa/EMC

80-019-30 3 m

80-019-50 5 m

Coagulation



Bipolares Anschlusskabel für bipolare Scheren, passend für Sutter/Martin/Berchtold/Aesculap/Integra/Spiggle&Theis, autoklavierbar

Bipolar connecting cable for bipolar scissors, compatible with Sutter/Martin/Berchtold/Aesculap/Integra/Spiggle&Theis, autoclavable

80-020-30 3 m
80-020-50 5 m



Nadelelektrode, monopolar, spitz, gewinkelt, 4 mm-Ansatz, 9,5 cm Arbeitslänge
Needle electrode, monopolar, pointed, angled, 4 mm plug, 9.5 cm working length

80-050-10



Kugelelektrode, monopolar, 2 mm, gewinkelt, 4 mm-Ansatz, 9,5 cm Arbeitslänge
Ball electrode, monopolar, 2 mm, angled, 4 mm plug, 9.5 cm working length

80-051-10

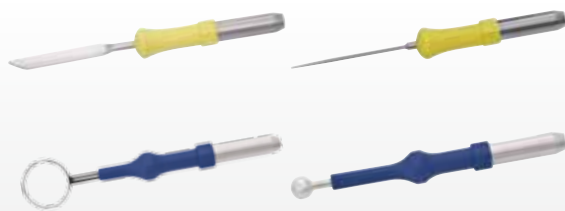

Monopolare Elektrode, 4 mm Ansatz
Monopolar electrode, 4 mm connection

80-052-01 Messer, gerade / blade, straight
80-052-02 Nadel, gerade / needle, straight
80-052-03 5 mm Schlinge, gerade / loop, straight
80-052-04 4 mm Kugel, gerade / ball, straight
80-052-05 2 mm Kugel, gerade / ball, straight

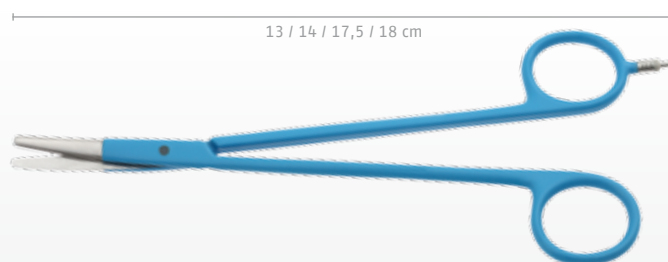

Bipolare Präparierschere, gebogen
Bipolar dissecting scissors, curved

80-080-13 13,0 cm
80-081-14 14,0 cm
80-082-17 17,5 cm
80-083-18 18,0 cm



80-080-13 80-081-14 80-082-17
standard Blatt / standard blades



80-083-18
feines Blatt / fine blades

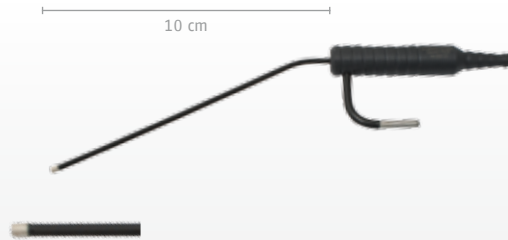

Koagulations-Saugrohr, monopolar, NON-STICK, gewinkelt, 2,5 mm AD, 3,5 mm Kugel, Saugkontrolle, 10 cm Arbeitslänge

Coagulation suction tube, monopolar, NON-STICK, angled, 2.5 mm OD, 3.5 mm ball end, suction control, 10 cm working length

80-060-10

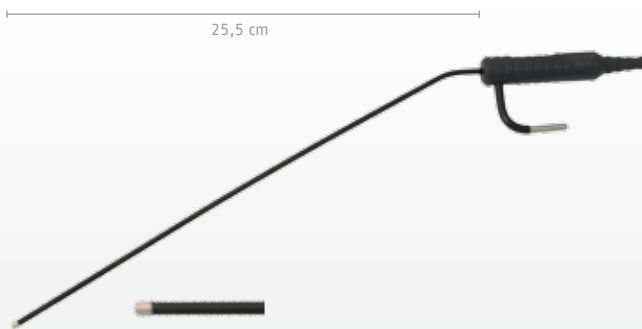

Koagulations-Saugrohr, monopolar, NON-STICK, gewinkelt, Saugkontrolle, 25,5 cm Arbeitslänge

Coagulation suction tube, monopolar, NON-STICK, angled, suction control, 25.5 cm working length

	AD / OD	Kugel / ball end
80-061-26	3,5 mm	3,5 mm
80-062-26	4,0 mm	4,0 mm

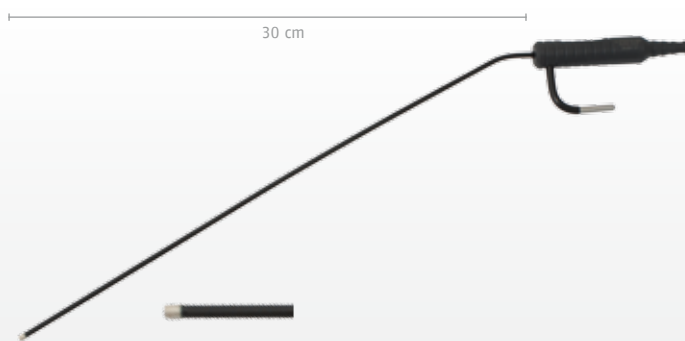

Koagulations-Saugrohr, monopolar, NON-STICK, gewinkelt, 3,5 mm AD, 5,0 mm Kugel, Saugkontrolle, 30 cm Arbeitslänge

Coagulation suction tube, monopolar, NON-STICK, angled, 3.5 mm OD, 5.0 mm ball end, suction control, 30 cm working length

80-063-30

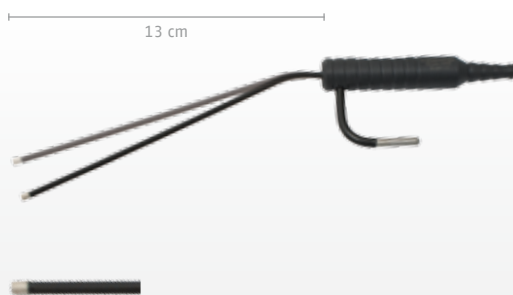

Koagulations-Saugrohr, monopolar, NON-STICK, biegsam, 4,3 mm AD, 4,3 mm Kugel, Saugkontrolle, 13 cm Arbeitslänge

Coagulation suction tube, monopolar, NON-STICK, flexible, 4.3 mm OD, 4.3 mm ball end, suction control, 13 cm working length

80-064-13

NON-STICK BIPOLARE PINZETTEN

Hightech Pinzetten zum attraktiven Preis

Bis heute stellt das Verkleben beim Koagulieren mit bipolaren Pinzetten ein großes Problem für den Operateur dar. Unsere NON-STICK Bipolare Pinzetten lösen dieses Problem effektiv und langfristig.

Vorteile:

- Kein Verkleben durch Arbeitsteile aus massivem Silber mit Goldüberzug
- Präzises Arbeiten ohne Unterbrechungen
- Perfekte Parallelführung durch Stopp-Führungsstift
- Flächiges Koagulieren durch Perfect-Grip-Arbeitsteil
- Autoklavierbar
- Passend für alle gängigen HF-Systeme durch Standard-Anschluss
- Qualität "Made in Germany"

Funktionen:

- Punktuelle Überhitzungen werden vermieden. Das Gewebe löst sich leicht von der Pinzette.
- Diese Eigenschaften bleiben bei ordnungsgemäßer Anwendung über die gesamte Lebensdauer des Instruments erhalten.

NON-STICK BIPOLAR FORCEPS

High-tech forceps for a low-tech price

Adhesion during coagulating is a major problem for surgeons. Our NON-STICK bipolar forceps solve this problem easily and reliably.

Advantages:

- No adhesion due to gold plated solid silver tips
- Precise working without interruptions
- Perfect parallel motion through guide pin
- Parallel tips provide optimal coagulation
- Autoclavable
- Standard adapter grants compatibility to all current HF-systems
- Quality "Made in Germany"

Functions:

- No punctual overheating – Tissue detaches easily from forceps.
- With correct usage, these characteristics are retained for the entire life span of the instrument.



X-FINE bipolare Pinzette, NON-STICK, bajonett, Spitze gerade, mit Stopp-Führungsstift
 X-FINE bipolar forceps, NON-STICK, bayonet, tip straight, with guide pin

	Länge / Length	Spitze / Tip
80-150-17	17 cm	0,4 x 4,0 mm
80-150-20	20 cm	0,4 x 4,0 mm
80-150-23	23 cm	0,4 x 4,0 mm
80-152-17	17 cm	0,7 x 4,0 mm
80-152-20	20 cm	0,7 x 4,0 mm
80-152-23	23 cm	0,7 x 4,0 mm



X-FINE bipolare Pinzette, NON-STICK, bajonett, Spitze aufwärts gewinkelt, mit Stopp-Führungsstift
 X-FINE bipolar forceps, NON-STICK, bayonet, tip upwards angled, with guide pin

	Länge / Length	Spitze / Tip
80-156-20	20 cm	0,4 x 4,0 mm
80-156-23	23 cm	0,4 x 4,0 mm



X-FINE bipolare Pinzette, NON-STICK, bajonett, Spitze abwärts gewinkelt, mit Stopp-Führungsstift
 X-FINE bipolar forceps, NON-STICK, bayonet, tip downwards angled, with guide pin

	Länge / Length	Spitze / Tip
80-158-20	20 cm	0,4 x 4,0 mm
80-158-23	23 cm	0,4 x 4,0 mm

Coagulation



**Bipolare Pinzette, NON-STICK,
gerade, Führungsstift**
Bipolar forceps, NON-STICK,
straight, guide pin

	Länge / Length	Spitze / Tip
80-100-16	16,0 cm	0,5 mm
80-100-19	19,5 cm	0,5 mm
80-101-16	16,0 cm	1,0 mm
80-101-19	19,5 cm	1,0 mm
80-101-22	22,0 cm	1,0 mm
80-103-16	16,0 cm	2,0 mm
80-103-19	19,5 cm	2,0 mm



**Bipolare Pinzette, NON-STICK,
gerade, Spitze gewinkelt, Führungsstift**
Bipolar forceps, NON-STICK,
straight, angled tip, guide pin

	Länge / Length	Spitze / Tip
80-105-16	16,0 cm	0,5 mm
80-105-19	19,5 cm	0,5 mm
80-106-16	16,0 cm	1,0 mm
80-106-19	19,5 cm	1,0 mm
80-106-25	25,0 cm	1,0 mm
80-107-16	16,0 cm	2,0 mm
80-107-19	19,5 cm	2,0 mm



**Bipolare Pinzette, NON-STICK,
bajonett, Führungsstift**
Bipolar forceps, NON-STICK,
bayonet, guide pin

	Länge / Length	Spitze / Tip
80-109-16	16,0 cm	0,3 mm
80-110-16	16,0 cm	0,5 mm
80-110-19	19,5 cm	0,5 mm
80-111-16	16,0 cm	1,0 mm
80-111-19	19,5 cm	1,0 mm
80-112-16	16,0 cm	2,0 mm
80-112-19	19,5 cm	2,0 mm



**Bipolare Pinzette, NON-STICK,
bajonett, Spitze 5 mm lang, Führungsstift**
Bipolar forceps, NON-STICK,
bayonet, tip 5 mm long, guide pin

	Spitze / Tip
80-113-19	0,3 mm
80-114-19	0,5 mm
80-115-19	1,0 mm
80-116-19	1,5 mm



Bipolare Pinzette, NON-STICK, bajonett, Spitze nach oben gewinkelt, Führungsstift, 19,5 cm
 Bipolar forceps, NON-STICK, bayonet, tip angled upwards, guide pin, 19.5 cm

Spitze / Tip

- 80-117-19 0,3 mm
- 80-118-19 1,0 mm
- 80-119-19 2,0 mm



Bipolare Pinzette, NON-STICK, bajonett, kurze isolierte Spitze, nach oben gewinkelt, Führungsstift, 1,5 mm, 19,5 cm
 Bipolar forceps, NON-STICK, bayonet, short isolated tip, angled upwards, guide pin, 1.5 mm, 19.5 cm

80-120-19



Bipolare Pinzette nach Meuser, NON-STICK, 60° gebogen, Führungsstift, 2,0 mm, 18 cm
 Bipolar forceps Meuser, NON-STICK, 60° curved, guide pin, 2.0 mm, 18 cm

80-121-18



Bipolare Pinzette, NON-STICK, kniegebogen, extra fein, 0,3 mm, 16 cm
 Bipolar forceps, NON-STICK, angled, very fine, 0.3 mm, 16 cm

80-123-16



Bipolare Pinzette, NON-STICK, bajonett, Spitze nach oben gewinkelt, Führungsstift, 25 cm
 Bipolar forceps, NON-STICK, bayonet, tip angled upwards, guide pin, 25 cm

Spitze / Tip

- 80-127-03 0,3 mm
- 80-127-07 0,7 mm
- 80-127-12 1,2 mm
- 80-127-20 2,0 mm
- 80-129-12 1,2 mm lange Spitze / long tip

Coagulation



Bipolare Pinzette, NON-STICK, bajonett, Spitze nach unten gewinkelt, Führungsstift, 25 cm
 Bipolar forceps, NON-STICK, bayonet, tip angled downwards, guide pin, 25 cm

Spitze / Tip

80-128-03	0,3 mm
80-128-07	0,7 mm
80-128-12	1,2 mm
80-128-20	2,0 mm



Bipolare Pinzette, NON-STICK, bajonett, Spitze gerade, Führungsstift, 25 cm
 Bipolar forceps, NON-STICK, bayonet, straight tip, guide pin, 25 cm

Spitze / Tip

80-125-03	0,3 mm
80-125-07	0,7 mm
80-125-12	1,2 mm
80-125-20	2,0 mm



Bipolare Pinzette nach Meuser mit Absaugung, 60° gebogen, 3,2 mm, 21 cm
 Meuser bipolar forceps with suction, 60° angled, 3.2 mm, 21 cm

80-122-18



Bipolare Saugpinzette, Saugunterbrecher, bajonett, 20 cm
 Bipolar suction forceps, suction control, bayonet, 20 cm

Spitze / Tip

80-183-14	1,4 mm
80-183-20	2,0 mm



Siebkorb mit Deckel, 3/4,
Edelstahl, gelocht, 405x255x75 mm
Storage- and cleaning tray with lid,
3/4, stainless steel, perforated, 405x255x75 mm

80-260-34

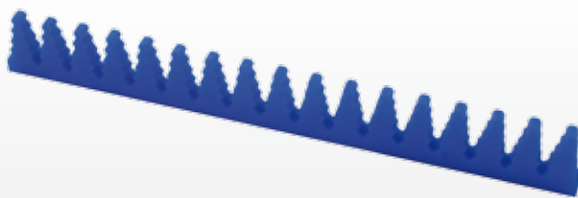

Silikonhalterung, Typ 1,
Bäumchen, T-Profil, blau, 24 cm
Silicone holder, type 1,
tree shaped, t-profile, blue, 24 cm

80-270-24



Silikonhalterung, Typ 2,
Universal, T-Profil, blau, 24 cm
Silicone holder, type 2,
universal, t-profile, blue, 24 cm

80-272-24



Leiste für Silikonhalterungen,
Edelstahl, T-Profil, 24 cm
Bar for silicone holders,
stainless steel, t-profile, 24 cm

80-275-24



Schraube, Edelstahl, M2, 9 x 16 mm
Screw, stainless steel, M2, 9 x 16 mm

80-280-00

Coagulation

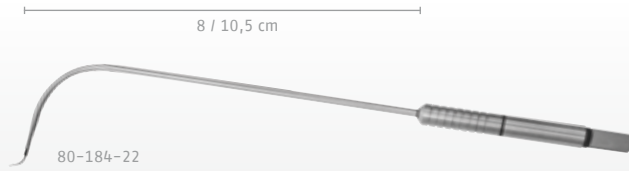

Meuser bipolare Elektrode, Titan
Meuser bipolar electrode, titanium

	AL / WL	
80-184-22	90°	8,0 cm
80-185-22	45°	10,5 cm

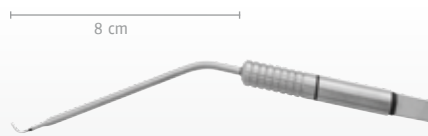

Bipolare Elektrode, gewinkelt, für Nase, Titan, 8 cm Arbeitslänge
Bipolar electrode, angled, for nasal use, titanium, 8 cm working length

80-190-08



Bipolare Elektrode, gewinkelt, für Tonsillen, Titan, 11 cm Arbeitslänge
Bipolar electrode, angled, for tonsils, titanium, 11 cm working length

80-190-11



Bipolare Elektrode, gewinkelt, für Larynx, Titan, 27 cm Arbeitslänge
Bipolar electrode, angled, for larynx, titanium, 27 cm working length

50-365-27

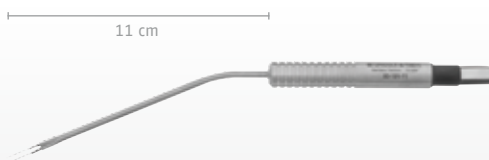

Bipolare Nadel-Elektrode, gewinkelt, für Nasenmuschel, Titan, 11 cm Arbeitslänge
Bipolar needle electrode, angled, for turbinates, titanium, 11 cm working length

80-191-11



Tracheotomy, Neck Dissection, Miscellaneous



Sternberg Lippenhaken
Sternberg lip retractor

80-302-12 12 cm
80-302-14 14 cm
80-302-16 16 cm

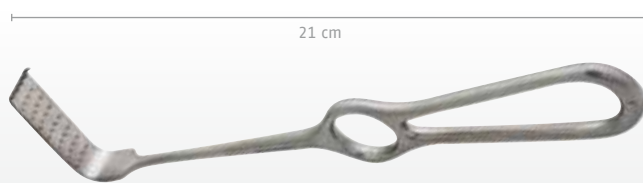

Brünings-Brunk Wundhaken, gezahnt, 21 cm
Brünings-Brunk antrum retractor, with teeth, 21 cm

80-304-00



Middeldorpf Wundhaken, Ringgriff, 20 cm
Middeldorpf antrum retractor, ring handle, 20 cm

Maße / Dimensions

80-306-17 14 x 17 mm
80-306-22 20 x 22 mm
80-306-30 26 x 30 mm



Kocher-Langenbeck Wundhaken, Ringgriff, 21 cm
Kocher-Langenbeck retractor, ring handle, 21 cm

Maße / Dimensions

80-308-06 25 x 6 mm
80-308-07 35 x 8 mm
80-308-10 35 x 11 mm
80-308-15 35 x 15 mm
80-308-20 60 x 20 mm



Langenbeck Wundhaken, Ringgriff, 21 cm
Langenbeck retractor, ring handle, 21 cm

Maße / Dimensions

80-309-11 30 x 11 mm
80-309-14 30 x 14 mm
80-309-16 30 x 16 mm
80-309-41 40 x 11 mm
80-309-51 50 x 11 mm

Tracheotomy, Neck Dissection, Miscellaneous



Volkman Wundhaken, Ringgriff, 23 cm
Volkman retractor, ring handle, 23 cm

- 80-330-01 1-zinkig, scharf / 1 prong, sharp
- 80-330-02 2-zinkig, scharf / 2 prongs, sharp
- 80-330-03 3-zinkig, scharf / 3 prongs, sharp
- 80-330-04 4-zinkig, scharf / 4 prongs, sharp
- 80-330-06 6-zinkig, scharf / 6 prongs, sharp
- 80-332-01 1-zinkig, stumpf / 1 prong, blunt
- 80-332-02 2-zinkig, stumpf / 2 prongs, blunt
- 80-332-03 3-zinkig, stumpf / 3 prongs, blunt
- 80-332-04 4-zinkig, stumpf / 4 prongs, blunt
- 80-332-06 6-zinkig, stumpf / 6 prongs, blunt



Schönborn Schilddrüsenhaken, 6 x 13 mm, 21 cm
Schönborn thyroid retractor, 6 x 13 mm, 21 cm

80-312-21



**Senn-Miller Wundhaken,
doppelendig, 3 Zähne, 16 cm**
Senn-Miller retractor,
double ended, 3 teeth, 16 cm

- 80-314-16 stumpf / blunt
- 80-315-16 scharf / sharp



**Orbita Gelenksperrer,
3 Zähne links, Blatt rechts, 16,5 cm**
Orbita retractor,
3 prongs left, blade right, 16.5 cm

- 80-310-01 Blatt links / blade left
- 80-310-02 Blatt rechts / blade right



Roux Wundhaken, doppelendig, 16,5 cm
Roux retractor, double ended, 16.5 cm

Größe / Size

- 80-318-01 19 x 22/23 x 30 mm
- 80-318-02 25 x 26/28 x 38 mm
- 80-318-03 28 x 29/33 x 45 mm



Tracheotomy, Neck Dissection, Miscellaneous



Baby-Roux Haken, doppelendig, 18 x 17 und 24 x 21 mm, 12,5 cm
 Baby-Roux retractor, double ended, 18 x 17 and 24 x 21 mm, 12.5 cm

80-317-00



Trachealhäkchen, glatter Griff, 17 cm
 Trachea hook, flat handle, 17 cm

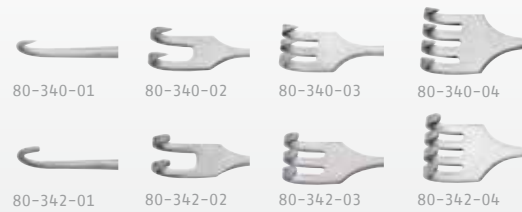

- 80-340-01 1-zinkig, scharf / 1 prong, sharp
- 80-340-02 2-zinkig, scharf / 2 prongs, sharp
- 80-340-03 3-zinkig, scharf / 3 prongs, sharp
- 80-340-04 4-zinkig, scharf / 4 prongs, sharp
- 80-342-01 1-zinkig, stumpf / 1 prong, blunt
- 80-342-02 2-zinkig, stumpf / 2 prongs, blunt
- 80-342-03 3-zinkig, stumpf / 3 prongs, blunt
- 80-342-04 4-zinkig, stumpf / 4 prongs, blunt



Halsted Mosquito-Klemme, 12,5 cm
 Halsted-Mosquito artery forceps, 12.5 cm



- 80-350-01 gerade, anat. / straight anat.
- 80-350-02 gebogen, anat. / curved, anat.
- 80-350-03 gerade, chir. / straight, 1:2 teeth
- 80-350-04 gebogen, chir. / curved, 1:2 teeth



Halsted Mosquito-Klemme, mikro, 12,5 cm
 Halsted-Mosquito artery forceps, micro, 12.5 cm



- 80-352-01 gerade, anat. / straight anat.
- 80-352-02 gebogen, anat. / curved, anat.
- 80-352-03 gerade, chir. / straight, 1:2 teeth
- 80-352-04 gebogen, chir. / curved, 1:2 teeth

Tracheotomy, Neck Dissection, Miscellaneous



Halsted Mosquito-Klemme, 18 cm
Halsted-Mosquito artery forceps, 18 cm

- 80-354-01 gerade, anat. / straight anat.
- 80-354-02 gebogen, anat. / curved, anat.
- 80-354-03 gerade, chir. / straight, 1:2 teeth
- 80-354-04 gebogen, chir. / curved, 1:2 teeth



Präparierklemme ohne Sperre, anatomisch
Artery forceps without ratchet, anatomical

- 80-356-12 gerade, 12 cm / straight
- 80-359-14 gerade, 14 cm / straight
- 80-357-12 leicht gebogen, 12 cm /
slightly curved
- 80-360-14 leicht gebogen, 14 cm /
slightly curved
- 80-361-14 stark gebogen, 14 cm /
strongly curved



**Parotis Spreizklemme,
leicht gebogen, 14,5 cm**
Parotis spreading clamp,
slightly curved, 14.5 cm

80-363-15



Tracheotomy, Neck Dissection, Miscellaneous



Pean Arterienklemme, anatomisch, fein
Pean artery forceps, anatomical, fine

- 80-365-14 gerade, 14,0 cm / straight
- 80-365-16 gerade, 16,5 cm / straight
- 80-366-14 gebogen, 14,0 cm / curved
- 80-366-16 gebogen, 16,5 cm / curved



Kocher Arterienklemme, chirurgisch, fein
Kocher artery forceps, 1:2 teeth, fine

- 80-370-14 gerade, 14 cm / straight
- 80-370-16 gerade, 16 cm / straight
- 80-372-14 gebogen, 14 cm / curved
- 80-372-16 gebogen, 16 cm / curved

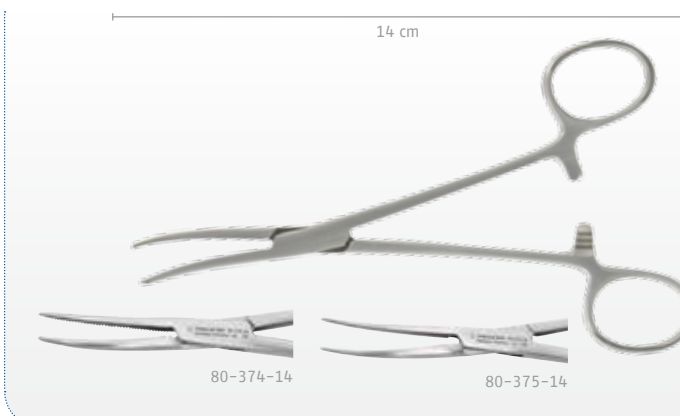

Crile Arterienklemme, anatomisch, gebogen, 14 cm
Crile artery forceps, anatomical, curved, 14 cm

- 80-374-14 normal / standard
- 80-375-14 mikro / micro

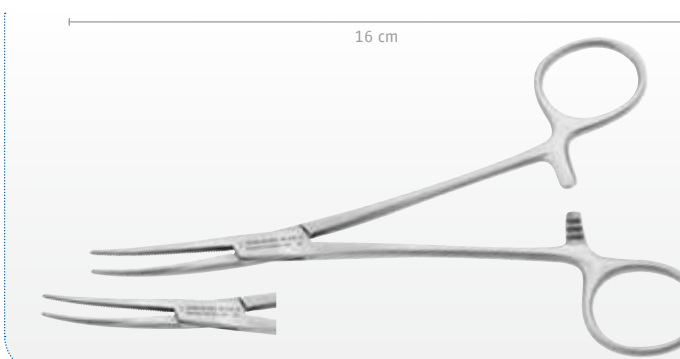

Crile-Coller Arterienklemme, anatomisch, gebogen, 16 cm
Crile-Coller artery forceps, anatomical, curved, 16 cm

- 80-376-16



Tracheotomy, Neck Dissection, Miscellaneous



**Baby-Adson Präparierklemme,
90° gebogen, 18 cm**
Baby-Adson artery forceps,
90° curved, 18 cm

80-380-18



**Rochester-Pean Arterienklemme,
anatomisch, gerade**
Rochester-Pean artery forceps,
anatomical, straight

80-382-18 18,5 cm
80-382-20 20,0 cm



**Rochester-Pean Arterienklemme,
anatomisch, gebogen**
Rochester-Pean artery forceps,
anatomical, curved

80-383-18 18,5 cm
80-383-20 20,0 cm
80-383-22 22,0 cm



**Ochsner-Kocher Arterienklemme,
chirurgisch, 1:2 Zähne**
Ochsner-Kocher artery forceps,
1:2 teeth

80-385-18 gerade, 18,5 cm / straight
80-385-20 gerade, 20,5 cm / straight
80-387-18 gebogen, 18,5 cm / curved
80-387-20 gebogen, 20,5 cm / curved

gerade / straight

gebogen / curved





Tracheotomy, Neck Dissection, Miscellaneous

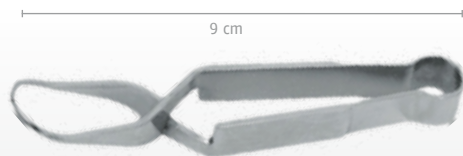

**Schädel Tuchklemme,
scharf, gebogen, 9 cm**
Schädel towel clamp,
sharp, curved, 9 cm

80-390-09



**Backhaus Tuchklemme,
scharf, gebogen**
Backhaus towel clamp,
sharp, curved

80-392-09 9,0 cm
80-392-11 11,0 cm
80-392-13 13,5 cm



**Edna-Lorna Tuchklemme,
stumpf, gerade, für Papiertücher**
Edna-Lorna towel clamp,
blunt, straight, for paper towels

80-394-09 9,5 cm
80-394-13 13,5 cm

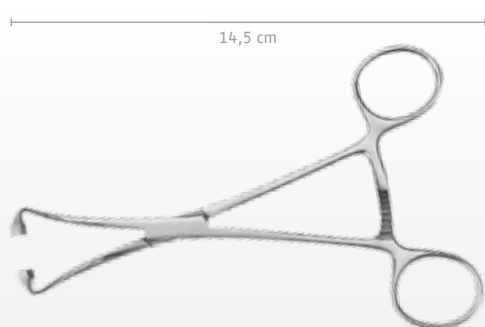

**Peers Tuchklemme,
stumpf, gebogen, für Papiertücher, 14,5 cm**
Peers towel clamp,
blunt, curved, for paper towels, 14.5 cm

80-396-14



**Tuchklemme zum schonenden
Fassen von Papiertüchern,
Kugel, gebogen, 13 cm**
Towel clamp for careful holding
of paper towels, ball-end, curved, 13 cm

80-397-13



Tracheotomy, Neck Dissection, Miscellaneous



Allis Gewebe-Fasszange,
gerade, 4:5 Zähne, 15,5 cm
Allis tissue holding forceps,
straight, 4:5 teeth, 15.5 cm

80-400-15

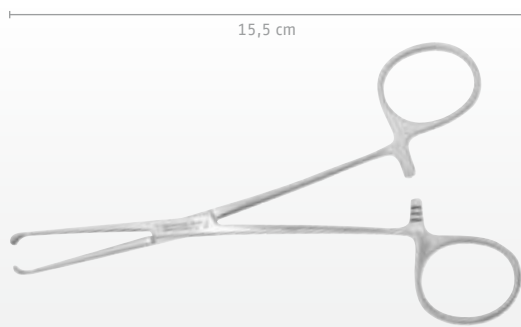

Baby-Allis Gewebe-Fasszange,
gerade, 4:5 Zähne, 15,5 cm
Baby-Allis tissue holding forceps,
straight, 4:5 teeth, 15.5 cm

80-401-14



Braun Haken-Zange,
4:4 Zähne, scharf, gerade, 15,5 cm
Braun hook forceps,
4:4 teeth, sharp, straight, 15.5 cm

80-403-15



Duval Gewebefasszange,
gerade, 14 mm breit, 20 cm
Duval tissue forceps,
straight, 14 mm wide, 20 cm

80-405-20





Tracheotomy, Neck Dissection, Miscellaneous



**Collin Zungenzange,
gerade, 16 cm**
Collin tongue forceps,
straight, 16 cm

80-407-16



**Young Zungenzange,
gebogen, mit Gummieinlage, 15,5 cm**
Young tongue forceps,
curved, with rubber insert, 15.5 cm

80-409-15

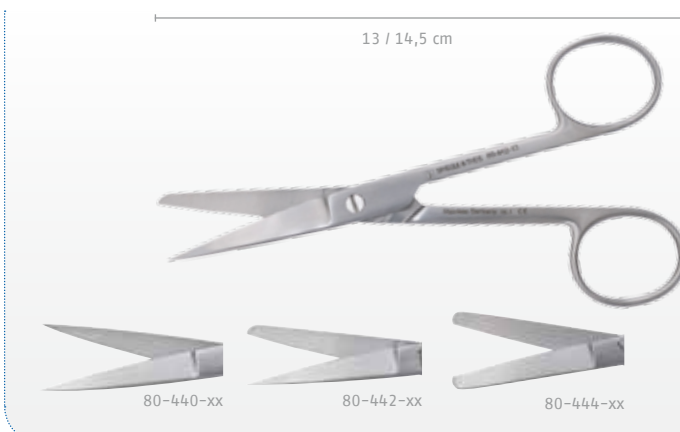

Cooper Schere, gerade
Cooper scissors, straight

- 80-440-13 spitz-spitz, 13,0 cm / sharp-sharp
- 80-440-15 spitz-spitz, 14,5 cm / sharp-sharp
- 80-442-13 spitz-stumpf, 13,0 cm / sharp-blunt
- 80-442-15 spitz-stumpf, 14,5 cm / sharp-blunt
- 80-444-13 stumpf-stumpf, 13,0 cm / blunt-blunt
- 80-444-15 stumpf-stumpf, 14,5 cm / blunt-blunt

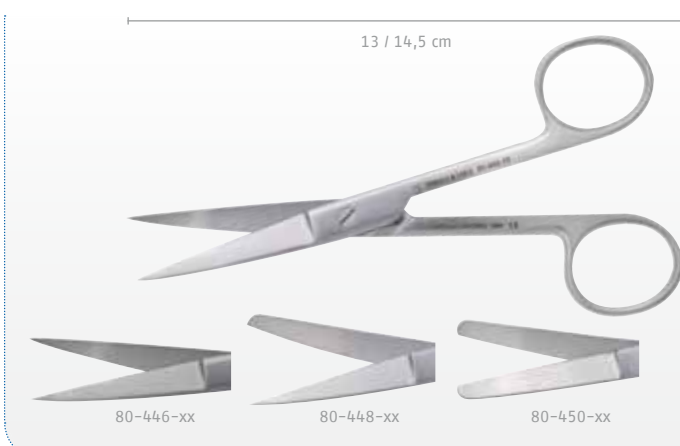

Cooper Schere, gebogen
Cooper scissors, curved

- 80-446-13 spitz-spitz, 13,0 cm / sharp-sharp
- 80-446-15 spitz-spitz, 14,5 cm / sharp-sharp
- 80-448-13 spitz-stumpf, 13,0 cm / sharp-blunt
- 80-448-15 spitz-stumpf, 14,5 cm / sharp-blunt
- 80-450-13 stumpf-stumpf, 13,0 cm / blunt-blunt
- 80-450-15 stumpf-stumpf, 14,5 cm / blunt-blunt

Tracheotomy, Neck Dissection, Miscellaneous



Mayo-Still Schere, stumpf-stumpf, 15 cm
 Mayo-Still scissors, blunt-blunt, 15 cm

- 80-455-15 gerade / straight
- 80-457-15 gebogen / curved



Mayo-Still Schere, Hartmetall, stumpf-stumpf, 15 cm
 Mayo-Still scissors, tungsten carbide, blunt-blunt, 15 cm

- 80-459-15 gerade / straight
- 80-460-15 gebogen / curved



Lister Verbandschere, gewinkelt
 Lister bandage scissors, angled

- 80-465-15 14,5 cm
- 80-465-18 18,0 cm
- 80-465-20 20,0 cm



Kilian Laryngofissur-Schere, gewinkelt, gezahnt, 21 cm
 Kilian laryngectomy scissors, angled, serrated, 21 cm

- 80-468-21





Tracheotomy, Neck Dissection, Miscellaneous



**Kocher Führungssonde,
mit Öffnung, 11 mm, 16 cm**
Kocher director,
with opening, 11 mm, 16 cm

80-470-16



Hohlsonde, gerade, 14,5 cm
Hollow probe, straight, 14.5 cm

80-471-15

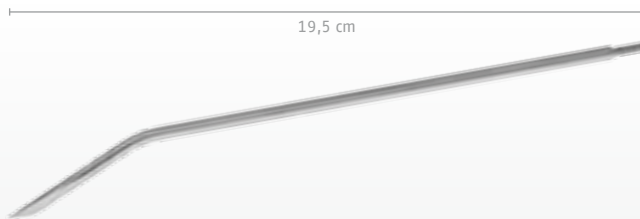

**Redon Führungsnadel,
Lanzettspitze, leicht gebogen, 19,5 cm**
Redon guide needle,
lancet tip, slightly curved, 19.5 cm

AD / OD

80-472-25 2,5 mm
80-472-35 3,5 mm
80-472-40 4,0 mm
80-472-45 4,5 mm
80-472-50 5,0 mm
80-472-60 6,0 mm



**Redon Führungsnadel,
Lanzettspitze, stark gebogen, 19,5 cm**
Redon guide needle,
lancet tip, strongly curved, 19.5 cm

AD / OD

80-473-25 2,5 mm
80-473-35 3,5 mm
80-473-40 4,0 mm



**Ueckermann Nottrokar
mit Silberkanüle, 9,0 mm, 11,5 cm**
Ueckermann tracheotomy trocar
with silver canula, 9.0 mm, 11.5 cm

80-480-09



Tracheotomy, Neck Dissection, Miscellaneous



**Laborde Trachealdilatator,
3-armig, 14 cm**
Laborde tracheal dilator,
3 prongs, 14 cm

80-478-14

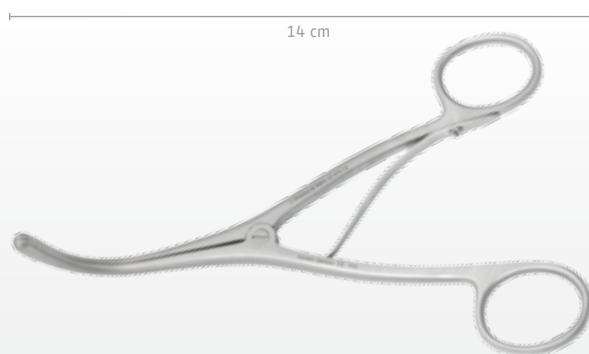

**Laborde Trachealdilatator,
2-armig, 14 cm**
Laborde tracheal dilator,
2 prongs, 14 cm

80-479-14



Weerda Tracheal-Spekulum, 19 cm
Weerda tracheal speculum, 19 cm

80-482-19

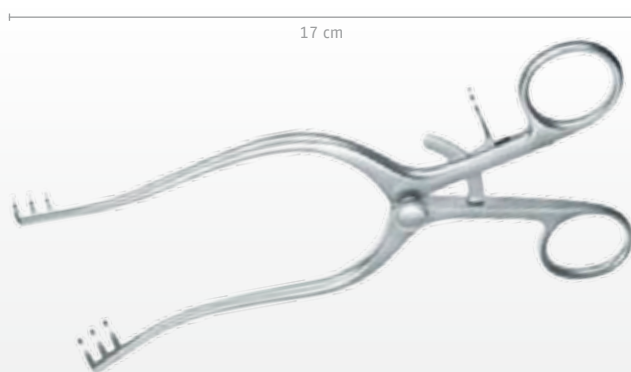

**Denecke Laryngofissur-Sperrer,
3:3 Zähne, 17 cm**
Denecke laryngectomy retractor,
3:3 teeth, 17 cm

80-485-17



Tracheotomy, Neck Dissection, Miscellaneous



Metallschale
Metal bowl

80-501-01	B1	Ø 4,0 cm	H=1,9 cm	20 ml
80-501-02	B2	Ø 6,0 cm	H=3,9 cm	60 ml
80-501-03	B3	Ø 8,5 cm	H=4,0 cm	160 ml
80-501-04	B4	Ø 11,0 cm	H=5,5 cm	400 ml



Medizinbecher, Edelstahl, graduert
Medicine cup, stainless steel, graduated

80-503-03	Ø 5,0 cm	H=2,5 cm	30 ml
80-504-05	Ø 5,3 cm	H=4,5 cm	50 ml



Lösungsschale, Edelstahl
Solution bowl, stainless steel

80-506-30	B1	Ø 10,0 cm	H=6,5 cm	300 ml
80-507-40	B2	Ø 12,0 cm	H=7,0 cm	400 ml
80-509-75	B3	Ø 15,0 cm	H=7,5 cm	750 ml



Tablettenschale, Edelstahl, Ø 6,5 cm, H=2 cm
Tablet dish, stainless steel, Ø 6.5 cm, H=2 cm

80-512-00



Petrirschale, Klarglas, mit Deckel
Petri bowl, clear glass, with lid

	Ø	Höhe / Height
80-515-06	6,0 cm	1,5 cm
80-515-08	8,0 cm	1,5 cm
80-515-10	15,0 cm	2,0 cm



Medikamenten-Schälchen,
Glas, schwarz, mit Deckel, 4 x 4 cm
Medicine cup,
glass, black, with lid, 4 x 4 cm

80-517-00



Tracheotomy, Neck Dissection, Miscellaneous



**Medikamenten-Schälchen,
Dappenglas, farbig, Ø 3,2 cm**
Medicine cup,
dappen-glass, coloured, Ø 3.2 cm

80-519-00 kristall / crystal
80-519-01 grün / green
80-519-02 rosa / pink
80-519-03 topas / topaz



Porzellan-Schälchen, rund, mit Ausguss
China bowl, round, with nozzle

	Ø
80-520-06	8,0 cm
80-520-08	10,0 cm



Nierenschale, Edelstahl
Kidney bowl, stainless steel

80-525-17	17,5 cm
80-525-25	25,0 cm



Kornzangen-Behälter, Edelstahl
Forceps holder, stainless steel

	Ø	Höhe / Height
80-528-13	5,0 cm	13,5 cm
80-528-18	5,0 cm	18,0 cm
80-528-20	9,5 cm	20,0 cm



**Kornzangen-Behälter,
Glas, Edelstahldeckel mit
Ausschnitt, Ø 8 cm, Höhe 20 cm**
Forceps holder,
glass, stainless steel lid with
opening, Ø 8 cm, height 20 cm

80-530-20



Tracheotomy, Neck Dissection, Miscellaneous



**Norm-Sterilisations-Container,
Normal-Boden, Ventil-Deckel mit Thermoloc,
Aluminium, Griff-Farbe nach Wahl**
Norm sterilisation container,
unperforated bottom, valve lid with thermoloc,
aluminium, handle color of your choice

80-630-12 29,6 x 27,5 x 12,0 cm

80-660-14 59,6 x 27,5 x 14,0 cm

80-660-21 59,6 x 27,5 x 21,0 cm



Siebkorb, Edelstahl-Drahtgeflecht, Fallgriffe
Basket, stainless-steel wire mesh, slide handles

80-670-25 24,5 x 24,5 x 6,0 cm

80-670-40 40,0 x 24,5 x 6,0 cm

80-670-49 48,5 x 24,5 x 6,0 cm



Codier-Schild, 6,0 x 2,0 cm, 20 Zeichen
Coding label, 6.0 x 2.0 cm, 20 characters

80-680-01 schwarz / black

80-680-02 rot / red

80-680-03 braun / brown

80-680-04 grün / green

80-680-05 gelb / yellow

80-680-06 lila / purple

80-680-07 blau / blue

Zubehör

Accessories

80-683-00 Container-Siegel, disposable, blau, 500 Stück/Box

Container seal, disposable, blue, 500 pieces/box

80-684-00 Indikator-Klebe-Etikett, Lasche rechts, 1000 Stück/Box

Adhesive indicator label, latch right side, 1000 pieces/box

80-685-00 Entsorgungsmarke, Edelstahl, zum Aufstecken, 2,5 x 3,0 cm, inclusive Gravur bis zu 5 Zeichen

Clip on coding clamp, stainless steel, 2.5 x 3.0 cm, including engraving up to 5 characters

80-688-00 Klemmschild aus Edelstahl, 6,0 x 4,0 cm, 25 Stück/Box

Stainless steel label, 6.0 x 4.0 cm, 25 pieces/box

Sets

40-980-00 Weichteilchirurgie-Set Neck dissection set

Bestehend aus / Consisting of:

Art.Nr./No.	Anz./Pcs.	Art.Nr./No.	Anz./Pcs.	Art.Nr./No.	Anz./Pcs.	Art.Nr./No.	Anz./Pcs.
80-308-07	2	40-400-20	1	20-744-17	1	10-360-11	1
80-308-15	2	40-405-20	1	40-500-19	1	10-360-15	1
80-308-20	2	40-450-19	6	40-380-12	1	20-615-18	2
80-312-21	2	40-455-20	2	10-352-14	1	40-441-18	1
80-332-04	2	40-457-19	2	20-306-20	1	20-610-25	1
80-330-04	2	40-462-18	2	20-309-20	1	20-615-15	2
80-330-06	2	80-403-15	2	80-470-16	1	20-601-14	2
80-340-01	2	80-400-15	2	10-465-15	1	10-534-12	1
20-582-10	2	80-350-01	10	10-468-17	1	20-624-11	1
10-481-14	1	80-350-02	10	20-150-75	1	80-442-15	1
10-482-14	1	80-392-09	12	80-468-21	1	80-448-15	1
10-484-14	2	80-366-14	10	20-252-03	1	80-471-15	1
10-485-14	2	80-366-16	6	40-420-29	1	80-504-05	2
10-486-16	1	80-374-14	6	30-080-09	1	80-501-03	1
20-710-12	1	80-370-14	6	30-080-12	1	40-474-20	1
20-496-12	1	80-357-12	3	30-080-15	1	80-528-18	1
20-712-12	1	40-465-18	1	10-360-03	1		
20-730-16	2	20-740-15	1	10-360-07	1		

40-940-00 Tonsillektomie/Adenotomie-Set Tonsillectomy/Adenotomy set

Bestehend aus / Consisting of:

Art.Nr./No.	Anz./Pcs.	Art.Nr./No.	Anz./Pcs.	Art.Nr./No.	Anz./Pcs.	Art.Nr./No.	Anz./Pcs.
40-300-02	1	40-550-05	1	40-230-21	1	40-457-19	1
40-305-00	1	40-553-02	1	40-355-28	1	40-465-18	1
40-318-01	1	40-555-13	1	40-359-27	1	80-106-19	1
40-318-02	1	40-200-00	1	40-381-15	1	80-017-45	1
40-318-03	1	40-200-01	1	40-390-21	1	80-392-09	6
40-318-04	1	40-200-02	1	40-406-20	1	80-504-05	2
40-500-19	1	40-200-03	1	40-420-29	1	80-501-03	1
40-520-00	1	40-220-02	1	40-430-19	1		
40-524-02	1	40-225-00	1	20-615-18	1		
40-524-06	1	20-254-03	1	40-450-19	1		

40-960-00 Tränenweg-Chirurgie-Set Lacrimal duct surgery set

Bestehend aus / Consisting of:

Art.Nr./No.	Anz./Pcs.	Art.Nr./No.	Anz./Pcs.	Art.Nr./No.	Anz./Pcs.	Art.Nr./No.	Anz./Pcs.
20-100-01	1	10-300-40	1	20-601-14	1	30-102-30	1
20-150-55	1	40-606-06	1	20-740-15	1	30-101-25	1
20-150-90	1	40-606-08	1	10-481-14	1	30-101-30	1
20-151-75	1	40-600-12	1	10-484-14	1	80-106-19	1
20-307-18	1	40-615-01	1	20-730-16	1	80-017-45	1
30-200-01	1	40-615-02	1	20-680-16	1	80-392-09	6
30-472-20	1	40-615-03	1	20-690-01	1	80-504-05	2
30-320-01	1	40-610-40	1	30-304-25	1	80-501-03	1
20-215-02	1	40-610-20	1	30-720-16	1		
20-225-02	1	40-610-12	1	30-722-16	1		
10-300-30	1	40-610-34	1	30-102-25	1		



Numeric Index

10-155-0014	40-232-2313	40-341-1320	40-522-0435
10-155-0114	40-235-1713	40-342-0920	40-522-0535
10-155-0214	40-248-0014	40-342-1120	40-522-0635
10-303-1827	40-248-1014	40-342-1320	40-522-0735
10-360-0333	40-249-0014	40-350-0020	40-522-0835
10-360-0433	40-300-0115	40-350-0120	40-522-0935
10-360-0733	40-300-0215	40-350-0220	40-522-1035
10-360-1033	40-302-0115	40-350-0320	40-522-2035
10-360-1133	40-302-0215	40-350-1020	40-522-3035
10-360-1533	40-302-0315	40-355-2821	40-524-0035
10-360-3333	40-302-0415	40-357-2821	40-524-0135
10-729-1845	40-303-0015	40-359-2721	40-524-0235
10-745-1222	40-305-0015	40-360-5021	40-524-0335
20-252-0112	40-305-1015	40-365-0122	40-524-0435
20-252-0212	40-305-9915	40-365-0222	40-524-0535
20-252-0312	40-310-0116	40-367-2422	40-524-0635
20-252-0412	40-310-0216	40-368-2123	40-524-0735
20-254-0012	40-310-0316	40-369-2123	40-524-0835
20-254-0112	40-311-0116	40-370-2123	40-524-0935
20-254-0212	40-311-0216	40-381-1223	40-524-1035
20-254-0312	40-311-0316	40-381-1523	40-524-2035
20-612-1829	40-311-0416	40-382-2424	40-524-3035
20-612-2029	40-311-1516	40-384-2424	40-526-0035
20-613-1830	40-311-2516	40-385-2324	40-526-0135
20-613-2030	40-311-3516	40-386-2324	40-526-0235
20-614-1829	40-312-0116	40-388-2124	40-526-0335
20-614-2029	40-312-0216	40-390-2125	40-526-0435
20-615-1830	40-312-0316	40-392-1925	40-526-0535
20-615-2030	40-312-0416	40-394-1825	40-526-0635
20-616-1830	40-312-0516	40-394-2325	40-526-0735
30-160-018	40-313-0116	40-395-2225	40-526-0835
30-160-028	40-313-0216	40-397-2125	40-526-0935
30-160-038	40-313-0316	40-400-2026	40-526-1035
30-170-286	40-313-0416	40-401-2026	40-526-2035
30-170-365	40-313-0516	40-402-2026	40-526-3035
30-171-406	40-315-0116	40-405-2026	40-550-0236
30-172-406	40-315-0216	40-406-2026	40-550-0536
30-173-406	40-315-0316	40-407-2026	40-550-1036
30-174-406	40-315-0416	40-408-2026	40-551-0236
30-182-217	40-315-0516	40-410-2026	40-551-0536
30-700-0119	40-316-0117	40-412-2026	40-551-1036
40-100-708	40-316-0217	40-420-2927	40-553-0136
40-100-908	40-316-0317	40-421-2127	40-553-0236
40-103-709	40-318-0117	40-430-1928	40-555-1336
40-103-909	40-318-0217	40-431-1928	40-558-2436
40-105-709	40-318-0317	40-433-1828	40-560-2237
40-105-909	40-318-0417	40-434-1828	40-561-2837
40-107-709	40-318-0517	40-436-1728	40-563-2537
40-108-709	40-320-0117	40-438-1828	40-570-0137
40-110-007	40-320-0217	40-440-1829	40-570-0237
40-110-307	40-320-0317	40-441-1829	40-572-0137
40-110-707	40-320-0417	40-442-1829	40-572-0237
40-112-007	40-320-0517	40-450-1930	40-575-0038
40-112-307	40-322-0217	40-451-1930	40-576-2038
40-112-707	40-322-0317	40-454-2031	40-578-0038
40-200-0010	40-322-0417	40-455-2031	40-579-0038
40-200-0110	40-322-0517	40-457-1931	40-580-0038
40-200-0210	40-323-0217	40-458-1931	40-581-0038
40-200-0310	40-323-0317	40-460-1931	40-600-1244
40-200-0410	40-323-0417	40-462-1831	40-601-1244
40-203-0010	40-323-0517	40-465-1832	40-604-0844
40-203-0110	40-325-0118	40-465-2032	40-604-1044
40-203-0210	40-325-0218	40-465-2332	40-604-1244
40-203-0310	40-325-0318	40-470-1832	40-606-0644
40-203-0410	40-325-0418	40-474-2032	40-606-0844
40-206-0010	40-327-0018	40-475-2632	40-610-1245
40-206-0110	40-327-0118	40-477-2032	40-610-2045
40-206-0210	40-327-0218	40-480-2233	40-610-3445
40-206-0310	40-327-0318	40-482-2333	40-610-4045
40-208-0110	40-327-9818	40-484-2233	40-613-0845
40-208-0210	40-327-9918	40-500-1934	40-615-0145
40-208-0310	40-330-0919	40-502-1734	40-615-0245
40-210-0011	40-330-1419	40-504-1534	40-615-0345
40-210-0111	40-330-9919	40-506-1934	40-617-0045
40-210-0211	40-335-0019	40-508-1834	40-940-0074
40-210-0311	40-335-0119	40-510-0134	40-960-0074
40-210-0411	40-337-0019	40-510-0234	40-980-0074
40-211-0711	40-338-0019	40-510-0334	50-365-2758
40-220-0111	40-340-0920	40-520-0036	70-211-008
40-220-0211	40-340-1120	40-522-0035	70-211-018
40-225-0011	40-340-1320	40-522-0135	70-211-108
40-226-0012	40-340-1520	40-522-0235	70-211-208
40-230-2113	40-341-1120	40-522-0335	70-211-308



Numeric Index

70-211-40	8	80-127-10	55	80-354-03	62	80-503-03	71
70-211-50	8	80-127-20	55	80-354-04	62	80-504-05	71
80-000-80	46	80-128-03	56	80-356-12	62	80-506-30	71
80-003-01	46	80-128-07	56	80-357-12	62	80-507-40	71
80-003-02	46	80-128-12	56	80-359-14	62	80-509-75	71
80-004-00	46	80-128-20	56	80-360-14	62	80-512-00	71
80-005-00	46	80-129-12	55	80-361-14	62	80-515-06	71
80-006-00	46	80-150-17	53	80-363-15	62	80-515-08	71
80-007-45	48	80-150-20	53	80-365-14	63	80-515-10	71
80-008-45	48	80-150-23	53	80-365-16	63	80-517-00	71
80-009-45	48	80-152-17	53	80-366-14	63	80-519-00	72
80-010-40	47	80-152-20	53	80-366-16	63	80-519-01	72
80-011-40	47	80-152-23	53	80-370-14	63	80-519-02	72
80-012-75	47	80-156-20	53	80-370-16	63	80-519-03	72
80-013-40	47	80-156-23	53	80-372-14	63	80-520-06	72
80-014-45	48	80-158-20	53	80-372-16	63	80-520-08	72
80-015-45	48	80-158-23	53	80-374-14	63	80-525-17	72
80-016-30	49	80-183-14	56	80-375-14	63	80-525-25	72
80-016-50	49	80-183-20	56	80-376-16	63	80-528-13	72
80-017-30	49	80-184-22	58	80-380-18	64	80-528-18	72
80-017-50	49	80-185-22	58	80-382-18	64	80-528-20	72
80-018-30	49	80-190-08	58	80-382-20	64	80-530-20	72
80-018-50	49	80-190-11	58	80-383-18	64	80-621-05	7
80-019-30	49	80-191-11	58	80-383-20	64	80-622-56	7
80-019-50	49	80-260-34	57	80-383-22	64	80-623-22	7
80-020-30	50	80-270-24	57	80-385-18	64	80-630-12	73
80-020-50	50	80-272-24	57	80-385-20	64	80-660-14	44, 73
80-045-15	49	80-275-24	57	80-387-18	64	80-660-21	73
80-046-45	49	80-280-00	57	80-387-20	64	80-670-25	73
80-050-10	50	80-302-12	59	80-390-09	65	80-670-40	73
80-051-10	50	80-302-14	59	80-392-09	65	80-670-49	73
80-052-01	50	80-302-16	59	80-392-11	65	80-680-01	73
80-052-02	50	80-304-00	59	80-392-13	65	80-680-02	73
80-052-03	50	80-306-17	59	80-394-09	65	80-680-03	73
80-052-04	50	80-306-22	59	80-394-13	65	80-680-04	73
80-052-05	50	80-306-30	59	80-396-14	65	80-680-05	73
80-060-10	51	80-308-06	59	80-397-13	65	80-680-06	73
80-061-26	51	80-308-07	59	80-400-15	66	80-680-07	73
80-062-26	51	80-308-10	59	80-401-14	66	80-683-00	73
80-063-30	51	80-308-15	59	80-403-15	66	80-684-00	73
80-064-13	51	80-308-20	59	80-405-20	66	80-685-00	73
80-080-13	50	80-309-11	59	80-407-16	67	80-688-00	73
80-081-14	50	80-309-14	59	80-409-15	67	80-691-01	7
80-082-17	50	80-309-16	59	80-440-13	67	80-692-01	7
80-083-18	50	80-309-41	59	80-440-15	67	80-695-00	44
80-100-16	54	80-309-51	59	80-442-13	67	80-800-09	41
80-100-19	54	80-310-01	60	80-442-15	67	80-801-10	41
80-101-16	54	80-310-02	60	80-444-13	67	80-802-12	41
80-101-19	54	80-312-21	60	80-444-15	67	80-803-17	41
80-101-22	54	80-314-16	60	80-446-13	67	80-805-13	41
80-103-16	54	80-315-16	60	80-446-15	67	80-820-30	42
80-103-19	54	80-317-00	61	80-448-13	67	80-821-30	42
80-105-16	54	80-318-01	60	80-448-15	67	80-822-30	42
80-105-19	54	80-318-02	60	80-450-13	67	80-823-30	42
80-106-16	54	80-318-03	60	80-450-15	67	80-841-30	43
80-106-19	54	80-330-01	60	80-455-15	68	80-844-30	43
80-106-25	54	80-330-02	60	80-457-15	68		
80-107-16	54	80-330-03	60	80-459-15	68		
80-107-19	54	80-330-04	60	80-460-15	68		
80-109-19	54	80-330-06	60	80-465-15	68		
80-110-16	54	80-332-01	60	80-465-18	68		
80-110-19	54	80-332-02	60	80-465-20	68		
80-111-16	54	80-332-03	60	80-468-21	68		
80-111-19	54	80-332-04	60	80-470-16	69		
80-112-16	54	80-332-06	60	80-471-15	69		
80-112-19	54	80-340-01	61	80-472-25	69		
80-113-19	54	80-340-02	61	80-472-35	69		
80-114-19	54	80-340-03	61	80-472-40	69		
80-115-19	54	80-340-04	61	80-472-45	69		
80-116-19	54	80-342-01	61	80-472-50	69		
80-117-19	55	80-342-02	61	80-472-60	69		
80-118-19	55	80-342-03	61	80-473-25	69		
80-119-19	55	80-342-04	61	80-473-35	69		
80-120-19	55	80-350-01	61	80-473-40	69		
80-121-18	55	80-350-02	61	80-478-14	70		
80-122-18	56	80-350-03	61	80-479-14	70		
80-123-16	55	80-350-04	61	80-480-09	69		
80-125-03	56	80-352-01	61	80-482-19	70		
80-125-07	56	80-352-02	61	80-485-17	70		
80-125-12	56	80-352-03	61	80-501-01	71		
80-125-20	56	80-352-04	61	80-501-02	71		
80-127-03	55	80-354-01	62	80-501-03	71		
80-127-07	55	80-354-02	62	80-501-04	71		





Abraham Tosillennmesser	33	Halteband für Negus Bruststützen	19	Präparierklemme oh. Sperre	62
Allis Gewebefasszange	66	Halteband für Neutral-Elektrode	47	Raspatorium Würzburger Modell	24
Ansatzrohr	38	Hartmann Conchotom	12	Rattenzahn-Zängchen	42
Baby-Adson Präparierklemme	64	Hartmann Zungenspatel	34	Redon Führungsnadel	69
Baby-Allis Gewebefasszange	66	Haslinger Gaumensegelhalter	13	Reichert Epiglottis Halter	36
Baby-Roux Haken	61	Henke Raspatorium	24	Reinigungsbürste mit Grifföse	43
Backhaus Tuchklemme	65	Henke Raspatorium/Dissektor	23	Reinigungs-Set	43
Ballenger Fasszange	25	Herberhold Zungenspatel	18	Ring Zungenspatel	17
Bangerter Tränenwegkanüle	44	HF-Chirurgie-Gerät	46	Rochester-Pean Arterienklemme	64
Beckmann Ringmesser	10	High Grade flex. Nasopharyngoskop	5	Roeder Ligatur-Instrument	21
Biopsie-Zängchen	42	Hofer Gaumenbogenhaken	13	Roux Wundhaken	60
Bipolare Elektrode	58	Hohlsonde	69	Ruedemann Dilator	45
Bipolare Nadel Elektrode	58	HNO-Spülkorb	44	Russel-Davis Zungenspatel	16f
Bipolare Pinzette, NON-STICK	53-56	Huber Universal Handgriff	38	Saugrohr	27
Bipolare Präparierschere	50	Hurd Elevatorium/Retraktor	24	Seemann-Seiffert Mundsperrerr	20
Bipolare Saugpinzette	56	Hurd Unterbindungsnadel	22	Schädel Tuchklemme	65
Bipolares Anschlusskabel	49-50	Hurd Raspatorium/Retraktor	24	Seiffert Hechtmaulansatz	38
Birkett Tosillennklemme	31	Indikator-Klebe-Etikett	73	Schmeden Conchotom	12
Blohmke Fasszange	25	Injektionskanüle	36	Schmidt Tosillennklemme	30
Boettcher Tosillenschere	28	Jatho Nasenrachenzange	11	Schönborn Schilddrüsenhaken	60
Bowman Speichelgangsonde	45	Jennings Mundsperrerr	20	Seiffert Hechtmaulansatz	38
Braun Hakenzange	66	Jurasz Nasenrachenzange	11	Seiffert Tubensonde	45
Brünings Löffelansatz	38	Kabel für Neutral-Elektrode	47	Senn-Miller Wundhaken	60
Brünings Tosillennmesser	33	Kabierske Pulverbläser	14	Sialoskope nach Geisthoff	40f
Brünings Tosillenschnürer	21	Kehlkopf-Kanüle	36	Siebkorb	57, 73
Brünings Zungenspatel	34	Kehlkopfspiegel	35	Silikonhalterung	57
Brünings-Brunk Wundhaken	59	Kehlkopfschere	37	Silikon-Schützer für Mundsperrerr	15
Buchwald Zungenspatel	34	Kette für Mundsperrerr	19	Silikonformschlauch für Mundsperrerr	15
Codier-Schild	73	Kilian Kehlkopfwatteträger	37	Skalpell-Griff	33
Collin Zungenzange	67	Kilian Laryngofissur-Schere	68	Skalpell-Klingen	33
Colver Fasszange	25	Knopfkanüle	44	Sluder-Ballenger Tonsillotom	20
Colver-Fischer Tosillennmesser	33	Knotenführer	23	Speichelgang-Schere	44
Container-Siegel	73	Koagulations-Saugrohr	51	Speichelgang-Sonden-Set	45
Cooper Schere	67	Kocher Arterienklemme	63	St. Clair-Thomson Nasenrachenzange	12
Crile Arterienklemme	63	Kocher Führungssonde	69	St. Clair-Thomson Ringmesser	10
Crile-Coller Arterienklemme	63	Kocher-Langenbeck Wundhaken	59	Steinfang-Körbchen	43
Crile-Wood Nadelhalter	32	Kornzangenbehälter	72	Sternberg Lippenhaken	59
Davis-Boyle Mundsperrerr	15	Kugelelektrode	50	Stierlen Saugraspatorium	24
Davis-Boyle Mundsperrerr für Kinder	15	Laborde Trachealdilatator	70	Stubbs Ringmesser	10
Davis-Boyle Zungenspatel	16	Langenbeck Wundhaken	59	Tablettenschale	71
Davis-Meyer Mundsperrerr	15	Laryngoskop	9	Tapia Adenoid Spatel	34
Dean Tosillenschere	28	LED-Leuchtgriff	8	Thilenius Tosillenn-Abszess-Zange	32
DeBakey Pinzette	26	Leiste für Silikonhalterungen	57	Toennis-Adson Tosillenschere	29
Denecke Laryngofissur-Sperrerr	70	Lister Verbandschere	68	Tonsillektomie/Adenotomie-Set	74
Dingmann Mundsperrerr	18	Lösungsschale	71	Tosillenn-Pinzette	26
Dingmann Wangenhaken	18	Mayo-Stille-Schere	68	Tosillenn-Schlingen	21
Dingmann Zahnhaken	18	Mclvor Mundsperrerr	15	Trachealhäkchen	61
Dingmann Zungenspatel	18	Mclvor Zungenspatel	16	Tränenweg-Chirurgie-Set	74
Driffin Mundsperrerr-Aufhängung	19	Medikamentenschälchen	71	Tuchklemme	65
Duplay Tupferzange	32	Medizinbecher	71	Tyding Fasszange	25
Duval Gewebefasszange	66	Metallschale	71	Ueckermann Nottrokar	69
Edna-Lorna Tuchklemme	65	Metall-Spritze mit Glaszylinder	36	Ultra-Stop Antibeschlagmittel	8
Einpedal-Fußschalter	46	Metzenbaum Schere	29f	Universal Drahtschneideschere	22
Elektroden-Handgriff	46	Meuser bipolare Elektrode	58	Vogel Ringmesser	11
Endoskop	7	Middeldorf Wundhaken	59	Volkmann Wundhaken	60
Endoskop-Schutzhülse	7	Mikulicz Tosillennklemme	31	Weerda Tracheal-Spekulum	70
Endoskopie-Siebkorb	8	Monopolare Elektroden	50	Weichteilchirurgie-Set	74
Entsorgungsmarke	73	Monopolares Anschlusskabel	48f	White Fasszange	25
Ersatzglas für Grünwald Zerstäuber	14	Moritz-Schmidt Zungenspatel	34	Wilder Dilator	45
Ersatzglas für Metall-Spritze	36	Muck Tosillenschere	28	Yankauer Saugrohr	27
Eves Tosillenschnürer	21	Nadelelektrode	50	Young Zungenzange	67
Fadenhäkchen	23	Nager Gaumensegelhaken	13	Zoom Laryngoskop	9
Fass-Zängchen	42	Nager Unterbindungsnadel	22	Zungenspatel Mod. Würzburg	17
Fein Kehlkopfwatteträger	37	Narkosebügel	19		
Flexible Alligatorzange	7	Negus Bruststütze	19		
Flexible Löffelzange	7	Negus Ringmesser	10		
Flexible Reinigungsbürste	7	Negus Tosillennklemme	31		
Fraenkel Löffelansatz	38	Neutral-Elektrode	47		
Fremdkörper-Zängchen	42	Nierenschale	72		
Frenzel Zungenspatel	34	Norm-Sterilisations-Container	44, 73		
Good Tosillenschere	28	Ochsner-Kocher Arterienklemme	64		
Good-Schweckendiek Tosillenschere	28	Orbita Gelenksperrerr	60		
Greifer, 3-armig	43	Overholt-Geissdoerfer Tosillennklemme	31		
Griff für Kehlkopfspiegel	35	Parotis Spreizklemme	62		
Gross Kornzange	32	Pean Arterienklemme	63		
Gross-Maier Kornzange	32	Peers Tuchklemme	65		
Grünwald Zerstäuber-Set	14	Pelteson Kehlkopfwatteträger	37		
Gummi-Gebläse für Grünwald Zerstäuber	14	Petrischale mit Deckel	71		
Halsted Mosquito Klemme	61f	Porzellanschälchen	72		



Alphabetical Index

Abraham tonsil knife	33	Frenzel tongue depressor	34	Rat tooth forceps	42
Adhesive indicator label	73	Geisthoff micro sialoscope	40f	Redon guide needle	69
Anesthesia frame L-form	19	Good tonsil scissors	28	Reichert epiglottis holder	36
Allis tissue holding forceps	66	Good-Schweckendiek tonsil scissors	28	Ring tongue depressor	17
Artery forceps w/o ratchet	62	Grasper	43	Rochester-Pean artery forceps	64
Baby-Adson artery forceps	64	Gross sponge forceps	32	Roeder ligature instrument	21
Baby-Allis tissue holding forceps	66	Gross-Maier sponge forceps	32	Roux retractor	60
Baby-Roux retractor	61	Grünwald atomizer-set	14	Rubber bulb for Grünwald atomizer	14
Backhaus towel clamp	65	Halsted mosquito artery forceps	61f	Ruedemann dilator for infants	45
Ball electrode	50	Handle for laryngeal mirrors	35	Russel-Davis tongue depressor	16f
Ballenger tonsil forceps	25	Hartmann cutting forceps	12	Salivary duct probe set	45
Band for chest supports	19	Hartmann tongue depressor	34	Salivary duct scissors	44
Bangerter lacrimal duct cannula	44	Haslinger uvula retractor	13	Scalpel blades	33
Basket	57, 73	Henke raspatory	24	Scalpel handle	33
Bar for silicone holders	57	Henke raspatory / dissector	23	Schädel towel clamp	65
Beckmann adenoid curette	10	Herberhold tongue depressor	18	Schmeden cutting forceps	12
Biopsy forceps	42	HF surgical unit	46	Schmidt tonsil forceps	30
Bipolar connecting cable	49f	High Grade flexible endoscope	5	Schönborn thyroid retractor	60
Bipolar dissecting scissors	50	Hofer palate retractor	13	Seemann-Seiffert mouth gag	20
Bipolar electrode	58	Holding band for neutral electrode	47	Seiffert alligator tip	38
Bipolar forceps Meuser	58	Holding forceps	42	Seiffert eustachian tube probe	45
Bipolar forceps	53-56	Hollow probe	69	Senn-Miller retractor	60
Bipolar needle electrode	58	Huber Universal handle	58	Silicone holder	57
Bipolar suction forceps	56	Hurd dissector/retractor	24	Silicone insert for mouth gags	15
Birkett tonsil forceps	31	Hurd elevator/retractor	24	Silicone neutral electrode	47
Blohmke tonsil forceps	25	Hurd tonsil suture needle	22	Silicone tubing, slotted	15
Boettcher tonsil scissors	28	Injection needle	36	Single pedal footswitch	46
Bowman salivary duct probe	45	Instrument tray	44	Sluder-Ballenger tonsillotome + blade	20
Braun hook forceps	66	Jatho epipharyngeal forceps	11	Spare glass for Grünwald atomizer	14
Brünings tip	38	Jennings mouth gag	20	Spare glass for metal syringe	36
Brünings tongue depressor	34	Jurasz adenoid forceps	11	St. Clair-Thomson adenoid curette	10
Brünings tonsil knife	33	Kabierske powder blower	14	St. Clair-Thomson adenoid forceps	12
Brünings tonsil snare	21	Kidney bowl	72	Sternberg lip retractor	59
Brünings-Brunk antrum retractor	59	Kilian laryngeal cotton carrier	37	Stierlen suction-raspatory	24
Buchwald tongue depressor	34	Kilian laryngectomy scissors	68	Stone grasping basket	43
Cannula, ball-ended	44	Knot tier	23	Stubbs adenoid curette	10
Chain for mouth gags	19	Kocher artery forceps	63	Suction tube	27
China bowl	72	Kocher director	69	Suture hook	23
Cleaning brush with loop handle	43	Kocher-Langenbeck retractor	59	Tablet dish	71
Cleaning set	43	Laborde tracheal dilatator	70	Tapia adenoid spatula	34
Clip on coding clamp	73	Lacrimal duct surgery set	74	Thilenius tonsil abscess forceps	32
Coagulation suction tube	51	Laryngeal cannula	36	Toennis-Adson tonsil scissor	29
Coding label	73	Laryngeal forceps	37	Tongue depressor, Würzburg model	17
Collin tongue forceps	67	Laryngeal mirror	35	Tonsil dissecting forceps	26
Colver tonsil forceps	25	Laryngoscope	9	Tonsil dressing forceps	26
Colver-Fischer tonsil knife	33	LED light handle	8	Tonsil wire loops	21
Connecting tube	38	Lister bandage scissors	68	Tonsillectomy/Adenotomy set	74
Container seal	73	Mayo-Stille scissors	68	Towel clamp	65
Cooper scissors	67	Mclvor mouth gag	15	Trachea hook	61
Crile artery forceps	63	Mclvor tongue depressor	16	Tyding tonsil forceps	25
Crile-Coller artery forceps	63	Medication cup	71	Ueckermann tracheotomy trocar	69
Crile-Wood needle holder	32	Metal Bowl	71	Ultra-Stop antifog solution	8
Davis-Boyle mouth gag	15	Metal syringe with glass tube	36	Universal wire cutting scissors	22
Davis-Boyle tongue depressor	16	Metzenbaum scissors	29f	Vogel adenoid curette	60
Davis-Meyer mouth gag	15	Meuser bipolar electrode	58	Volkman retractor	60
Dean tonsil scissors	28	Meuser bipolar forceps	56	Weerda tracheal speculum	70
DeBaKey dressing forceps	26	Middeldorp antrum retractor	59	White tonsil forceps	25
Denecke laryngectomy retractor	70	Mikulicz tonsil forceps	31	Wilder dilatator	45
Dingmann cheek retractors	18	Monopolar connecting cable	48f	Yankauer suction tube	27
Dingmann mouth gag	18	Monopolar electrodes	50	Young tongue forceps	67
Dingmann tooth hooks	18	Moritz-Schmidt tongue depressor	34	Zoom laryngoscope	9
Dingmann tongue depressor	18	Muck tonsil scissors	28		
Draffin bipod suspension for mouth gags	19	Nager pillar retractor	13		
Duplay sponge forceps	32	Nager tonsil suture needle	22		
Duval tissue forceps	66	Neck dissection set	74		
Edna-Lorna towel clamp	65	Needle electrode	50		
Electrode handle	46	Negus adenoid curette	10		
Endoscope	7	Negus chest support	19		
Endoscope protective sleeve	7	Negus tonsil forceps	31		
Endoscopy container	8	Norm sterilization container	44, 73		
ENT instrument tray	44	Ochsner-Kocher artery forceps	64		
Eves tonsil snare	21	One pedal foot-switch	46		
Fein laryngeal cotton carrier	37	Orbital retractor	60		
Flexible alligator forceps	7	Overholt-Geissdoerfer tonsil forceps	31		
Flexible cleaning brush	7	Pean artery forceps	63		
Flexible cup forceps	7	Peers towel clamp	65		
Flexible endoscope	6	Pelteson laryngeal cotton carrier	37		
Foreign body forceps	42	Petri Bowl	71		
Fraenkel tip	38	Raspatory Würzburg type	24		





Deutsch



International

Spiggle & Theis Medizintechnik GmbH ist auch über Mobilgeräte wie Smartphones und Tablet-PCs erreichbar – einfach QR-Code scannen!
Spiggle & Theis Medizintechnik GmbH is also available for mobile devices like smart phones and tablet PC – simply scan QR code!

SPIGGLE & THEIS

Medizintechnik GmbH

Burghof 14

51491 Overath / Germany

Tel.: +49 (0) 2206 / 90 81 – 0

Fax: +49 (0) 2206 / 90 81 –13

info@spiggle-theis.de

www.spiggle-theis.de

www.spiggle-theis.com

© 2015 by Spiggle & Theis Medizintechnik GmbH

Änderungen und Druckfehler – auch für Bilder – vorbehalten.
Bitte beachten Sie, dass genannte Bemaßungen produktionsbedingt vom Original abweichen können. Bitte beachten Sie auch, dass ggf. nicht alle Produkte in Ihrem Land vertrieben werden.

Modifications and errors – including pictures – reserved.
Please note that due to production, the dimensions of the products may vary slightly to those stated. Please note also that not all goods might be for sale in your country.