

Larynx-Instrumentarium

Larynx Instruments

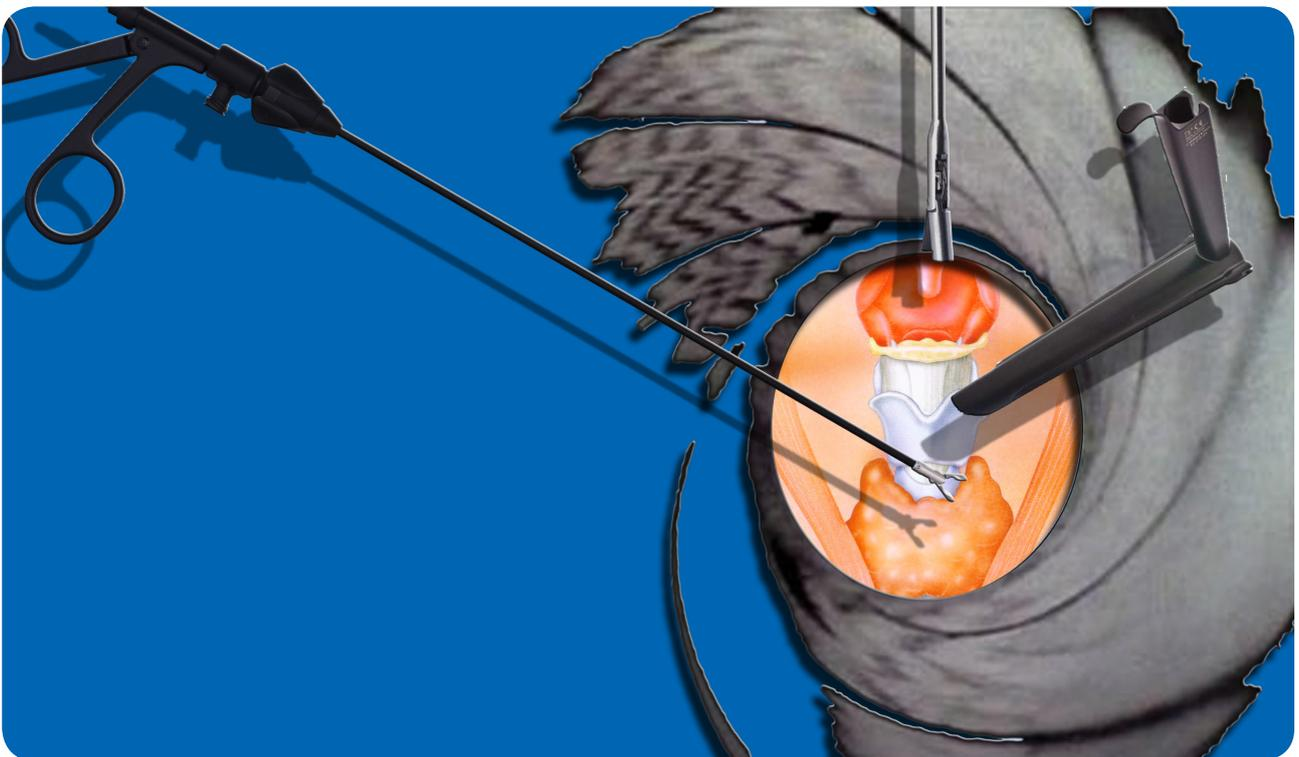



GESCHICHTE

Spiggle & Theis Medizintechnik GmbH wurde 1994 von den Geschäftsführern David Spiggle und Detlef Theis gegründet. Bis heute haben wir uns vom reinen Vertriebsunternehmen zu einem renommierten Hersteller von Medizinprodukten im Bereich der HNO-Chirurgie weiterentwickelt. Zu unseren Kunden in Deutschland zählen mehr als 700 Kliniken und wir exportieren mittlerweile in über 75 Länder weltweit.



HISTORY

Spiggle & Theis Medizintechnik GmbH was founded in 1994 by the managing directors David Spiggle and Detlef Theis. The company evolved from being purely a distributor to the established manufacturer of medical products in the area of ENT that it is today. We can count over 700 clinics amongst our german customers and we export to over 75 countries world wide.

DAS MASS DER DINGE

Im chirurgischen Instrumentenbau gilt das Siegel "MADE IN GERMANY" auch heute noch als Inbegriff von Qualität. Unsere chirurgischen Instrumente werden in allen Produktionsstufen unter strengsten Qualitätsanforderungen in Deutschland produziert, sind also noch echt "MADE IN GERMANY". Zur Verarbeitung wird ausschließlich Instrumentenstahl bester Güte verwendet, welcher den hohen Anforderungen moderner Chirurgie auch dauerhaft gerecht wird.

THE SEAL OF HIGHEST QUALITY

The stamp "MADE IN GERMANY" is still the epitome of quality standards in the production of surgical instruments in the world today. In Germany, our surgical instruments are subjected to the strictest quality requirements at every step of their production, so they are, in the truest sense of the words, "MADE IN GERMANY". Only the highest standard of instrument steel, capable of consistently meeting the demands of modern surgery, is used in the production.

SICHERHEIT ZUERST

Die Gesundheit der Patienten und somit die Sicherheit und Qualität unserer Produkte stehen immer im Mittelpunkt unseres Handelns. In diesem Sinne ist Spiggle & Theis Medizintechnik GmbH bereits seit 1997 ISO-zertifiziert und unsere Produkte nach der strengen europäischen Richtlinie für Medizinprodukte CE-gekennzeichnet. Alle unsere Produkte unterliegen einem permanenten Prozess der Qualitätskontrolle, von der Auswahl des Rohmaterials über die einzelnen Fertigungsschritte bis zum Versand.

SAFETY FIRST

The health of our patients and therefore the safety and quality of our products always plays a central role in our decisions. Spiggle & Theis Medizintechnik GmbH has been ISO certified and our products are CE-marked in accordance with the strict European guidelines for medical products since 1997. All our products undergo continual quality checks, from the selection of raw materials, to the individual stages of production and finally their dispatch.



SERVICE

Unsere Kollegen blicken zum Teil auf mehr als 30 Jahre Berufserfahrung im Umgang mit chirurgischen Instrumenten zurück. Dadurch besitzen wir mehr als theoretisches Wissen – Verständnis für die Bedürfnisse unserer Kunden. Darüber hinaus pflegen wir noch den engen, individuellen Kontakt mit den Anwendern. Dies hilft uns bei der steten, praxisorientierten Weiterentwicklung unserer Produkte. Somit garantieren wir hohe Kompetenz und individuellen Service bei der Betreuung unserer Kunden.

SERVICE

Our colleagues in instrument development can look back on over 30 individual years of professional practical experience with ENT-surgical instruments. We offer more than theoretical knowledge – we understand our customers needs. We enjoy close, personal contact to many of the best surgeons here in Germany. This enables us to continually develop innovative products. We guarantee the highest level of competence and individual service in meeting our customers requirements.





Contents

1 Bruststütze..... 5
1 Chest Support..... 5

2 Laryngoskope..... 6 - 10
2 Laryngoscopes..... 6 - 10

3 Zahnschutz..... 11
3 Teeth Protection..... 11

4 Mikroinstrumente..... 12 - 13
4 Micro Instruments..... 12 - 13

5 Saugrohre und Watteträger..... 14
5 Suction Tubes and Cotton Carriers..... 14

6 Hochfrequenz-Instrumente..... 15 - 17
6 High Frequency Instruments..... 15 - 17

7 Drehbare Zangen..... 18
7 Rotatable Forceps..... 18

8 Laryngoskopiezangen..... 19 - 22
8 Laryngoscopy Forceps..... 19 - 22

9 Spezialinstrumente..... 23
9 Special Instruments..... 23

10 Allgemeines..... 24 - 25
10 Miscellaneous..... 24 - 25

11 Sterilisationssysteme..... 26
11 Sterilizing Systems..... 26

12 Sets..... 27 - 29
12 Sets..... 27 - 29

Index..... 30 - 31
Index..... 30 - 31



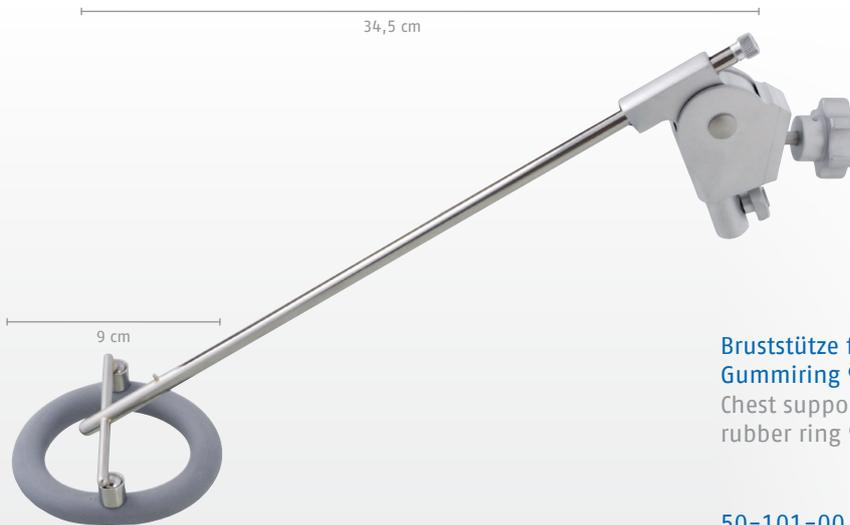

**Bruststütze für Erwachsene,
Gummiring 9 cm, Stützstange 34,5 cm**
Chest support for adults,
rubber ring 9 cm, rod 34.5 cm

50-101-00



**Stützstange für Bruststütze,
Gummiring 9,5 cm**
Rod for chest support,
rubber ring 9.5 cm

50-101-10 24 cm, für Kinder / for children
50-101-20 34 cm, für Erwachsene / for adults



Gummiring für Bruststütze, 9,5 cm
Rubber ring for chest support, 9.5 cm

50-101-40



Bruststütze alleine, ohne Stange
Chest support only, without rod

50-101-30



Laryngoscopes



Videolaryngoskop, Endoskopführung,
zur Verwendung mit Endoskop 50-155-00,
distal innen 18 x 13 mm, proximal innen 26 x 17 mm,
18,2 cm

Video laryngoscope, endoscope-guide,
for use with endoscope 50-155-00,
distal interior 18 x 13 mm, proximal interior 26 x 17 mm,
18.2 cm

50-150-00



Winkeloptik HD,
zur Verwendung mit Videolaryngoskop 50-150-00,
4,0 mm, 15°, 17,7 cm, autoklavierbar

Angled endoscope HD,
for use with video laryngoscope 50-150-00,
4.0 mm, 15°, 17.7 cm, autoclavable

50-155-00





Operations-Laryngoskop
Surgical laryngoscope

- 50-200-01 Größe 1 für Kleinkinder, 13,5 cm, ID 11 mm, AD 19,5 x 12 mm
Size 1 for small children, 13.5 cm, ID 11 mm, OD 19.5 x 12 mm
- 50-200-02 Größe 2 für Kinder, 15,2 cm, ID 11 mm, AD 20,5 x 13 mm
Size 2 for children, 15.2 cm, ID 11 mm, OD 20.5 x 13 mm
- 50-200-03 Größe 3 für Jugendliche, 18,1 cm, ID 12 mm, AD 21 x 13 mm
Size 3 for juveniles, 18.1 cm, ID 12 mm, OD 21 x 13 mm
- 50-200-04 Größe 4 für Frauen, 17,2 cm, ID 14,5 mm, AD 26,5 x 15 mm
Size 4 for women, 17.2 cm, ID 14.5 mm, OD 26.5 x 15 mm
- 50-200-05 Größe 5 für Männer, 17,2 cm, ID 15 mm, AD 29 x 19 mm
Size 5 for men, 17.2 cm, ID 15 mm, OD 29 x 19 mm
- 50-200-08 Größe 8 extra groß, 17 cm, ID 19 mm, AD 31 x 21 mm
Size 8 extra large, 17 cm, ID 19 mm, OD 31 x 21 mm

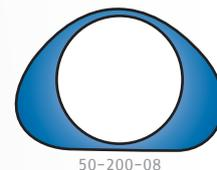
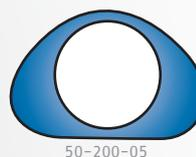
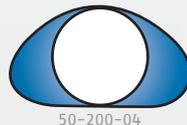

Operations-Laryngoskop, Größe 6,
für vordere Kommissur, 18,2 cm,
ID 18 x 13 mm, AD 26 x 17 mm
Surgical laryngoscope, size 6,
for anterior commissure, 18.2 cm,
ID 18 x 13 mm, OD 26 x 17 mm

50-200-06



Operations-Laryngoskop, Größe 7,
für lange Hälsa, 22,2 cm,
ID 18 x 13 mm, AD 26 x 17,5 mm
Surgical laryngoscope, size 7,
for long necks, 22.2 cm,
ID 18 x 13 mm, OD 26 x 17.5 mm

50-200-07

Laryngoscopes

13,5 / 15,2 / 17,2 / 18,2 cm

Operations-Laryngoskop, spreizbar
 Surgical laryngoscope, spreadable

- 50-202-01 **Größe 1 für Kleinkinder, 13,5 cm, ID 11 mm, AD 20 x 12 mm**
 Size 1 for small children, 13.5 cm, ID 11 mm, OD 20 x 12 mm
- 50-202-02 **Größe 2 für Kinder, 15,2 cm, ID 11 mm, AD 21 x 13 mm**
 Size 2 for children, 15.2 cm, ID 11 mm, OD 21 x 13 mm
- 50-202-03 **Größe 3 für Jugendliche, 18,2 cm, ID 12 mm, AD 21 x 13 mm**
 Size 3 for juveniles, 18.2 cm, ID 12 mm, OD 21 x 13 mm
- 50-202-04 **Größe 4 für Frauen, 17,2 cm, ID 14,5 mm, AD 27 x 15 mm**
 Size 4 for women, 17.2 cm, ID 14.5 mm, OD 27 x 15 mm
- 50-202-05 **Größe 5 für Männer, 17,2 cm, ID 16 mm, AD 29 x 19 mm**
 Size 5 for men, 17.2 cm, ID 16 mm, OD 29 x 19 mm

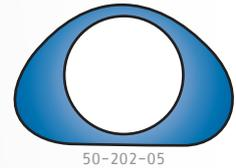

18,2 cm

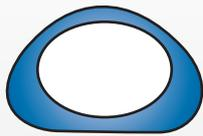
Operations-Laryngoskop, Größe 6, spreizbar, für vordere Kommissur, 18,2 cm, ID 18 x 13 mm, AD 26 x 17 mm
 Surgical laryngoscope, size 6, spreadable, for anterior commissure, 18.2 cm, ID 18 x 13 mm, OD 26 x 17 mm

50-202-06

22,2 cm

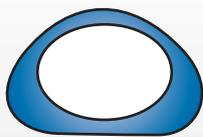
Operations-Laryngoskop, Größe 7, spreizbar, für lange Hälse, 22,2 cm, ID 18 x 13 mm, AD 26 x 17 mm
 Surgical laryngoscope, size 7, spreadable, for long necks, 22.2 cm, ID 18 x 13 mm, OD 26 x 17 mm

50-202-07



**Fiberglas-Lichtträger
für starre und spreizbare Laryngoskope, 14 cm**
Fiberglass lightcarrier
for rigid and spreadable laryngoscopes, 14 cm

Für Größen / For Sizes

- 50-205-12 1 / 2
- 50-205-36 3 / 4 / 5 / 6 / 8
- 50-205-70 7



**Rauchabsaugrohr
für starre und spreizbare Laryngoskope
Größe 3 bis 7, 14 cm**
Smoke evacuation tube
for rigid and spreadable laryngoscopes
size 3 to 7, 14 cm

50-207-17



**Inject-Timer-Kanüle
für starre und spreizbare Laryngoskope
Größe 1 bis 7, 11 cm**
Inject timer cannula
for rigid and spreadable laryngoscopes
size 1 to 7, 11 cm

50-209-17



**Köcher für Saugrohre,
40 cm, ø 40 mm, zum Einhängen an OP-Schiene**
Quiver for suction tubes,
40 cm, ø 40 mm, for hook on op-table bar

50-330-40



Laryngoscopes



13,5 / 15,2 / 17,2 / 18,1 cm

Laser-Laryngoskop
Laser laryngoscope

- 50-215-01 Größe 1 für Kleinkinder, 13,5 cm, ID 11 mm, AD 19,5 x 12 mm
Size 1 for small children, 13.5 cm, ID 11 mm, OD 19.5 x 12 mm
- 50-215-02 Größe 2 für Kinder, 15,2 cm, ID 11 mm, AD 20,5 x 13 mm
Size 2 for children, 15.2 cm, ID 11 mm, OD 20.5 x 13 mm
- 50-215-03 Größe 3 für Jugendliche, 18,1 cm, ID 12 mm, AD 21 x 13,5 mm
Size 3 for juveniles, 18.1 cm, ID 12 mm, OD 21 x 13.5 mm
- 50-215-04 Größe 4 für Frauen, 17,2 cm, ID 14,5 mm, AD 26,5 x 15 mm
Size 4 for women, 17.2 cm, ID 14.5 mm, OD 26.5 x 15 mm
- 50-215-05 Größe 5 für Männer, 17,2 cm, ID 16 mm, AD 29 x 18,5 mm
Size 5 for men, 17.2 cm, ID 16 mm, OD 29 x 18.5 mm



50-215-01



50-215-02



50-215-03

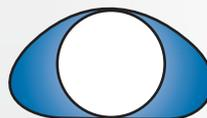

50-215-04

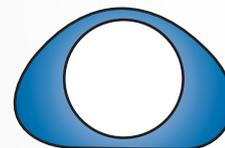

50-215-05



18,3 cm

Laser-Laryngoskop, Größe 6,
für vordere Kommissur, 18,3 cm,
ID 18 x 13 mm, AD 26 x 17 mm
Laser laryngoscope, size 6,
for anterior commissure, 18.3 cm,
ID 18 x 13 mm, OD 26 x 17 mm

50-215-06



22,2 cm

Laser-Laryngoskop, Größe 7,
für lange Häse, 22,2 cm,
ID 18 x 13 mm, AD 26 x 17,5 mm
Laser laryngoscope, size 7,
for long necks, 22.2 cm,
ID 18 x 13 mm, OD 26 x 17.5 mm

50-215-07





Fiberglas-Lichtträger für Laserlaryngoskope, 14 cm
Fiberglass lightcarrier for laser laryngoscopes, 14 cm

Für Größen / For Sizes

- 50-217-12 1 / 2
- 50-217-36 3 / 4 / 5 / 6
- 50-217-70 7



Rauchabsaugrohr für Laserlaryngoskope
Größen 3 bis 7, 15 cm
Smoke evacuation tube for laser laryngoscopes
size 3 to 7, 15 cm

50-218-17



Inject-Timer-Kanüle für Laserlaryngoskope
Größen 1 bis 7, 10 cm
Inject timer cannula for laser laryngoscopes
size 1 to 7, 10 cm

50-219-17



Holinger Laryngoskop,
mit Handgriff und Lichtträger, innen mattiert
Holinger laryngoscope,
with handle and light carrier, satin finish inside

Größen / Sizes

- 50-230-01 1 (12,0 cm)
- 50-230-02 2 (17,1 cm)
- 50-230-03 3 (18,0 cm)



Jackson Laryngoskop mit Handgriff und
Lichtträger, innen mattiert
Jackson laryngoscope with handle and
light carrier, satin finish inside

Größen / Sizes

- 50-233-01 1 (12,0 cm)
- 50-233-02 2 (17,1 cm)
- 50-233-03 3 (18,0 cm)



Teeth Protectors



**Endoragard Zahnschutz,
doppelseitig, Kunststoff, unsteril**
Endoragard teeth protector,
double side, plastic, non-sterile

50-240-00



Zahnschutz aus Metall, gelocht
Teeth protector, metal, with holes

Größen / Sizes

- 50-245-00 0, sehr klein / very small
- 50-245-01 1, klein / small
- 50-245-02 2, mittel / medium
- 50-245-03 3, groß / large



**Medasil Zahnschutz,
Silikon, steril, lasergeeignet, 20 Stück**
Medasil teeth protector,
silicone, sterile, laser resistant, 20 pieces

50-250-00





**Heermann Handgriff,
groß, schwarz, 13 cm**
Heermann handle,
large, black, 13 cm

10-722-13



Kleinsasser Handgriff, gewinkelt
Kleinsasser handle, angled

50-300-00



Sichelmesser, AL 22 cm
Sickle knife, WL 22 cm

50-310-23 gerade Schneide / straight edge
50-311-23 gebogene Schneide / curved edge



Messer, oval, AL 22 cm
Knife, oval, WL 22 cm

50-312-23



Messer, rund, 2,5 mm, 45° gewinkelt, AL 22 cm
Knife, round, 2.5 mm, 45° angled, WL 22 cm

50-313-23

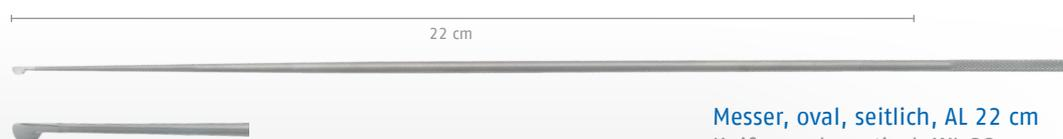

Messer, oval, seitlich, AL 22 cm
Knife, oval, vertical, WL 22 cm

50-314-23



Micro Instruments

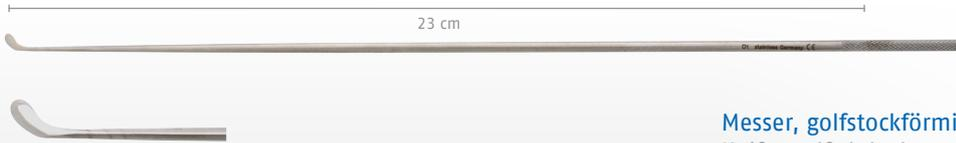

Messer, golfstockförmig, AL 23 cm
Knife, golf club shaped, WL 23 cm
50-315-23



Sonde, stumpf, gerade, AL 23 cm
Probe, blunt, straight, WL 23 cm
50-232-23



Häkchen, stumpf, 90°, AL 22 cm
Hook, blunt, 90°, WL 22 cm
50-317-23



Häkchen, retrograd, AL 23 cm
Hook, backwards, WL 23 cm
50-316-23 stumpf / blunt
50-318-23 scharf / sharp

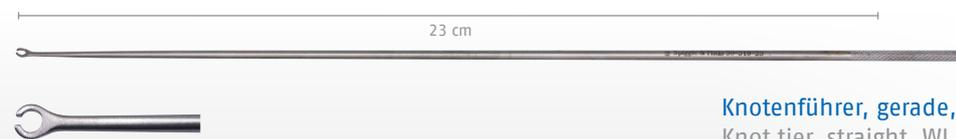

Knotenführer, gerade, AL 23 cm
Knot tier, straight, WL 23 cm
50-319-23



Umstechungsnadel, AL 22 cm
Suture needle, WL 22 cm
50-320-23 rechts gebogen / right curved
50-321-23 links gebogen / left curved



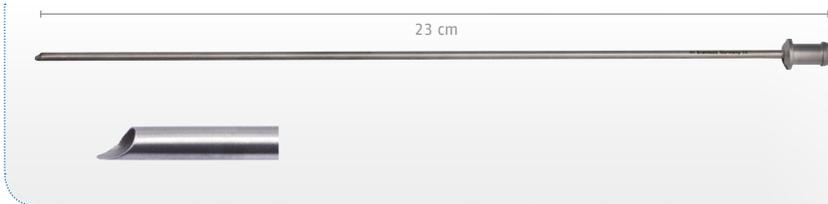

Saugraspatorium, gerade, 23 cm
Suction raspatory, straight, 23 cm

50-322-23

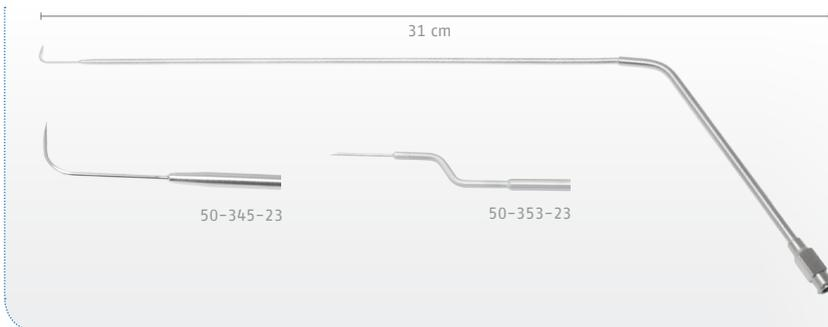

Injektionsnadel, 31 cm, AL 24 cm
Injection needle, 31 cm, WL 24 cm

50-345-23 gebogen / curved
50-353-23 bajonett / bayonet



Saugrohr mit Unterbrecher, kniegebogen, seitlich distale Öffnung, 25 cm
Suction tube with interruptor, angled, distal side opening, 25 cm

	ID / ID
50-347-20	2,0 mm
50-347-25	2,5 mm
50-347-30	3,0 mm



Saugrohr mit Unterbrecher, Spitze geschlossen, zwei seitliche Öffnungen 3,0 mm, 25 cm
Suction tube with interruptor, tip closed, two side openings of 3.0 mm, 25 cm

50-349-30

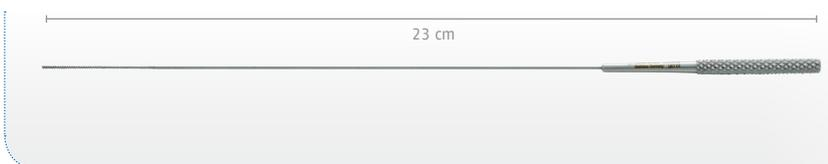

Watteträger, gerieft, 2 mm, 23 cm
Cotton carrier, serrated, 2 mm, 23 cm

50-351-23



High Frequency Instruments



**Koagulations-Saugrohr,
monopolar, NON-STICK, gewinkelt,
Saugkontrolle, 25,5 cm Arbeitslänge**
Coagulation suction tube,
monopolar, NON-STICK, angled,
suction control, 25.5 cm working length

	AD / OD	Kugel / Ball end
80-061-26	3,5 mm	3,5 mm
80-062-26	4,0 mm	4,0 mm

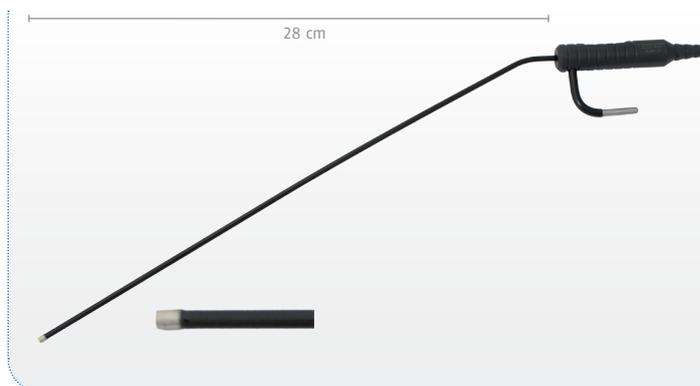

**Koagulations-Saugrohr,
monopolar, NON-STICK, gewinkelt,
4 mm AD, Saugkontrolle, 4 mm Kugel,
28 cm Arbeitslänge**
Coagulation suction tube,
monopolar, NON-STICK, angled,
4 mm OD, 4 mm ball end, suction control,
28 cm working length

80-063-30



**Bipolare Koagulationselektrode,
innen isoliert, 27 cm Arbeitslänge**
Bipolar coagulation electrode,
inside isolated, 27 cm working length

50-365-27





Monopolare Koagulationszange, drehbar,
Rauchabsaugung, Schaft 3,0 mm, 23,5 cm
Monopolar coagulation forceps, rotatable,
smoke evacuation, shaft 3.0 mm, 23.5 cm

- Monopolare Koagulation / Monopolar coagulation
- 360° drehbar / 360° rotatable
- Rauchabsaugung beim Lasern / Laser smoke evacuation
- Reflexarme schwarze Oberfläche / Non-reflecting black finish

- 50-400-23 gerade, gerieft / straight, serrated
- 50-402-23 gebogen, gerieft / curved, serrated
- 50-404-23 runde Löffel / round cups
- 50-406-23 ovale Löffel, gezahnt / oval cups, toothed



50-400-23



50-402-23



50-404-23



50-406-23

High Frequency Instruments



Monopolares Anschlusskabel für Instrumente, 4 mm, 4,5 m, passend für Sutter/Martin/Berchtold/Aesculap/Integra/Spiggle&Theis, autoklavierbar
 Monopolar connecting cable for instruments, 4 mm, 4.5 m, compatible with Sutter/Martin/Berchtold/Aesculap/Integra/Spiggle&Theis, autoclavable

80-014-45



Monopolares Anschlusskabel für Instrumente, 4 mm, 4,5 m, passend für Erbe ICC/ACC, Wolf/Storz, autoklavierbar

Monopolar connecting cable for instruments, 4 mm, 4.5 m, compatible with Erbe ICC/ACC, Wolf/Storz, autoclavable

80-015-45



Bipolares Anschlusskabel für Instrumente, Olympus/Söring/Coa/Erbe-Vio Intl., autoklavierbar

Bipolar connecting cable for instruments, Olympus/Söring/Coa/Erbe-Vio Intl., autoclavable

80-016-30 3 m
 80-016-50 5 m



Bipolares Anschlusskabel, passend für Sutter/Martin/Berchtold/Aesculap/Integra/Spiggle & Theis, autoklavierbar

Bipolar connecting cable, compatible to Sutter/Martin/Berchtold/Aesculap/Integra/Spiggle & Theis, autoclavable

80-017-30 3 m
 80-017-50 5 m



Bipolares Anschlusskabel, passend für Erbe/Storz/Wolf

Bipolar coagulation cable, compatible to Erbe/Storz/Wolf

80-018-30 3 m
 80-018-50 5 m



Bipolares Anschlusskabel, passend für Valleylab/Lamidey/Bowa/EMC

Bipolar coagulation cable, compatible to Valleylab/Lamidey/Bowa/EMC

80-019-30 3 m
 80-019-50 5 m



Vorteile drehbarer Instrumente / Advantages of rotatable instruments

- 360° drehbar / 360° rotatable
- Eine Zange für alle Richtungen / One forceps for all directions
- Kostenersparnis / Cost savings



Mikrolaryngoskopiezange, drehbar, runde Löffel 2,0 mm, mit Spülkanal, konischer Schaft (2,0 – 3,0 mm), gebogen, 23 cm
 Micro laryngeal forceps, rotatable, round cups, 2.0 mm, irrigation channel, conical shaft, (2.0 – 3.0 mm), curved, 23 cm

50-501-10

Mikrolaryngoskopiezange, drehbar, gerieft, mit Spülkanal, konischer Schaft (2,0 – 3,0 mm), gebogen, 23,5 cm
 Micro laryngeal forceps, rotatable, serrated, irrigation channel, conical shaft (2.0 – 3.0 mm), curved, 23.5 cm



50-502-10

Mikrolaryngoskopiezange, drehbar, dreieckiges Maul, gefenstert, mit Spülkanal, konischer Schaft (2,0 – 3,0 mm), gebogen, 23 cm
 Micro laryngeal forceps, rotatable, triangular jaws, fenestrated, irrigation channel, conical shaft (2.0 – 3.0 mm), curved, 23 cm



50-503-10

Mikrolaryngoskopieschere, drehbar, gebogen, mit Spülkanal, konischer Schaft (2,0 – 3,0 mm), 23,5 cm
 Micro laryngeal scissors, rotatable, curved, irrigation channel, conical shaft (2.0 – 3.0 mm), 23.5 cm



50-504-10

Laryngoscopy Forceps

Vorteile / Advantages

- Integrierter Spülkanal für optimierte Reinigung / Integrated irrigation channel for optimal cleaning
- Konischer Schaft für hohe Stabilität und optimale Sicht / Conical shaft for high stability and optimal view

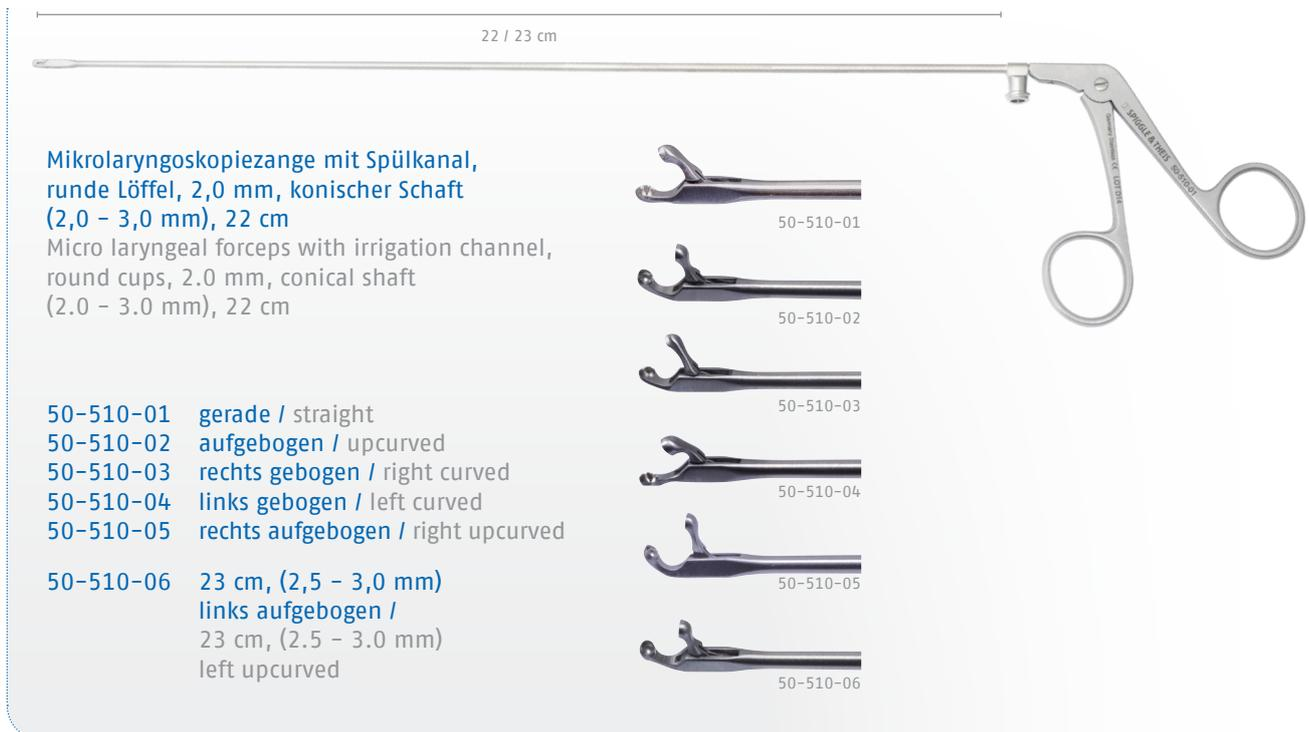

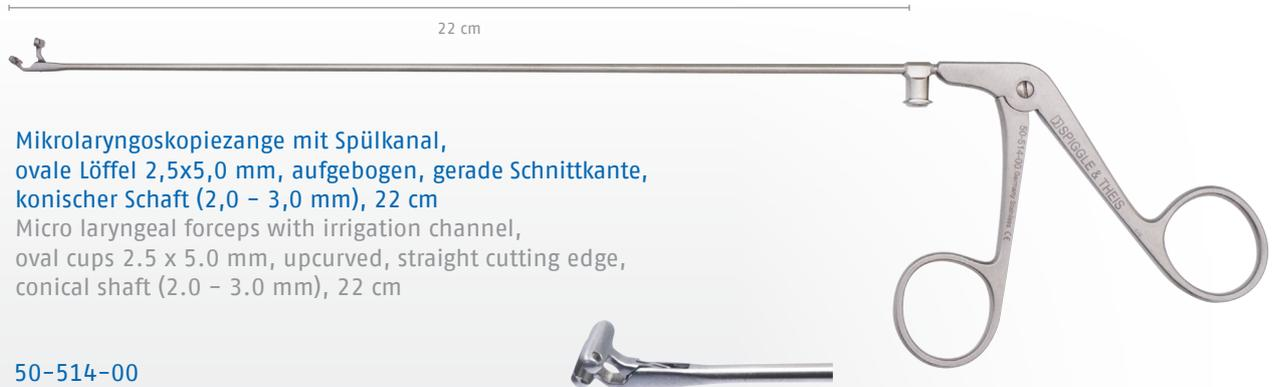

Mikrolaryngoskopiezange mit Spülkanal, ovale Löffel 2,5x5,0 mm, aufgebogen, gerade Schnittkante, konischer Schaft (2,0 – 3,0 mm), 22 cm
 Micro laryngeal forceps with irrigation channel, oval cups 2.5 x 5.0 mm, upcurved, straight cutting edge, conical shaft (2.0 – 3.0 mm), 22 cm

50-514-00

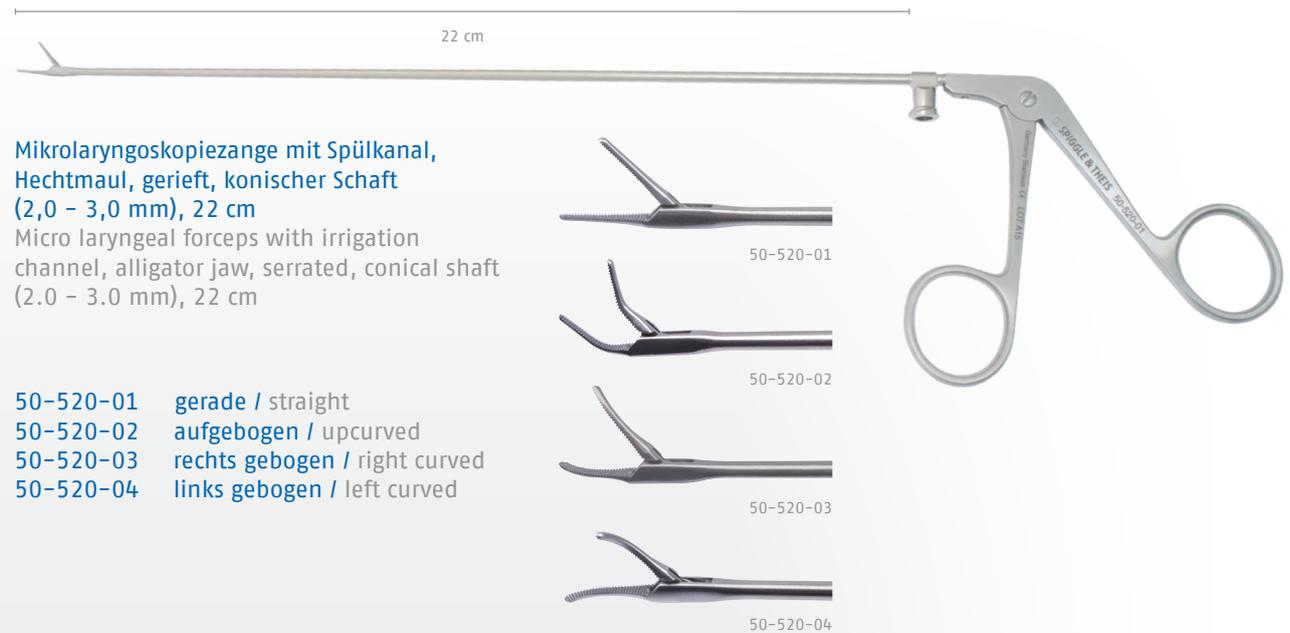

Mikrolaryngoskopiezange mit Spülkanal, Hechtmaul, gerieft, konischer Schaft (2,0 – 3,0 mm), 22 cm
 Micro laryngeal forceps with irrigation channel, alligator jaw, serrated, conical shaft (2.0 – 3.0 mm), 22 cm

- 50-520-01 gerade / straight
- 50-520-02 aufgebogen / upcurved
- 50-520-03 rechts gebogen / right curved
- 50-520-04 links gebogen / left curved

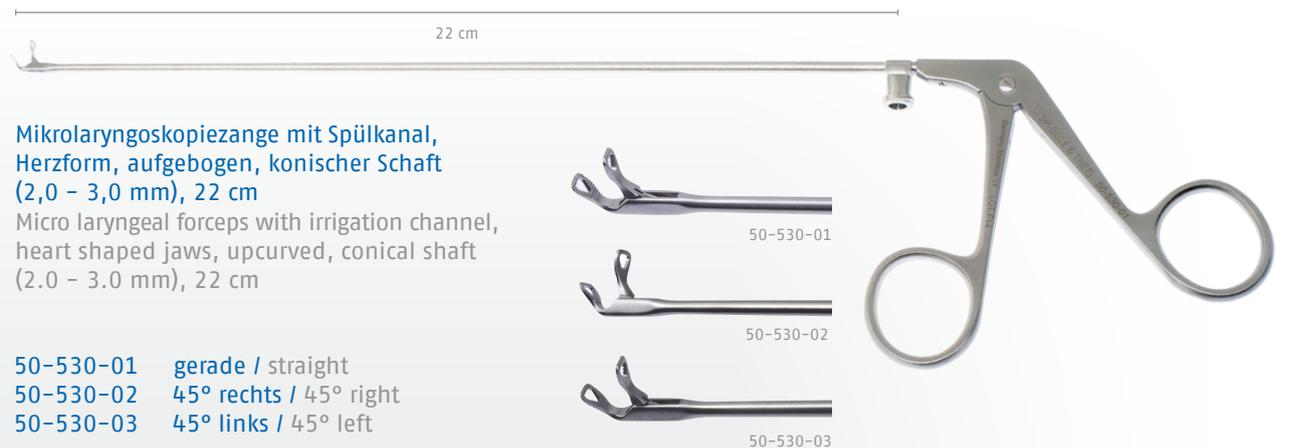

Mikrolaryngoskopiezange mit Spülkanal, Herzform, aufgebogen, konischer Schaft (2,0 – 3,0 mm), 22 cm
 Micro laryngeal forceps with irrigation channel, heart shaped jaws, upcurved, conical shaft (2.0 – 3.0 mm), 22 cm

- 50-530-01 gerade / straight
- 50-530-02 45° rechts / 45° right
- 50-530-03 45° links / 45° left

Laryngoscopy Forceps

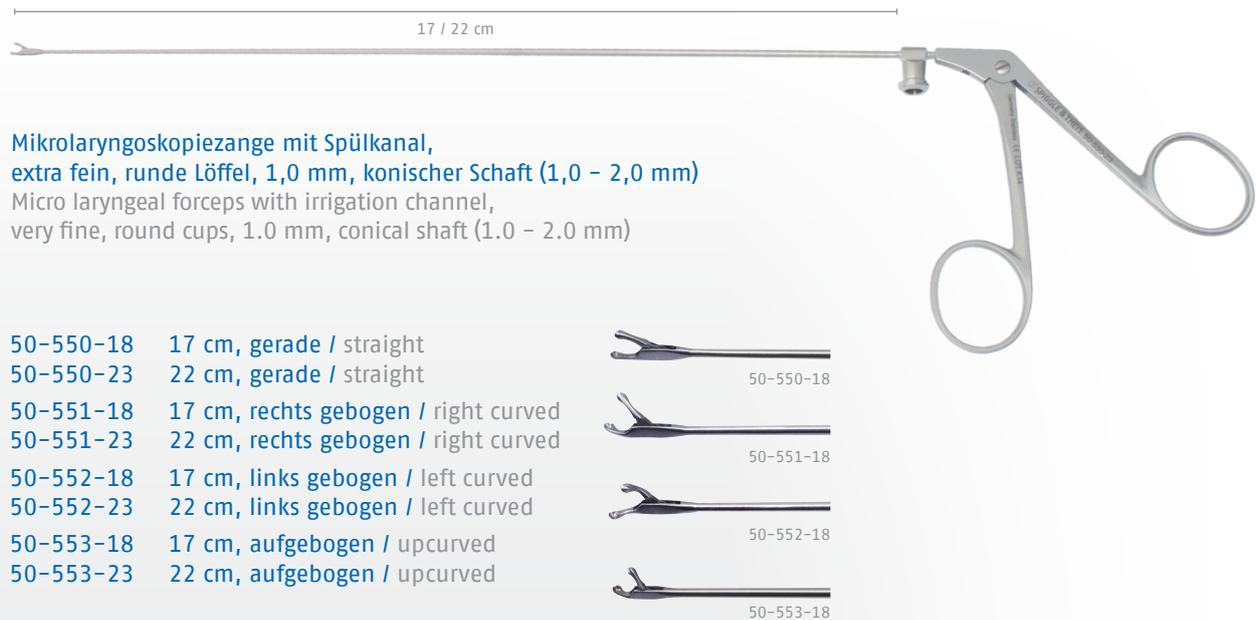
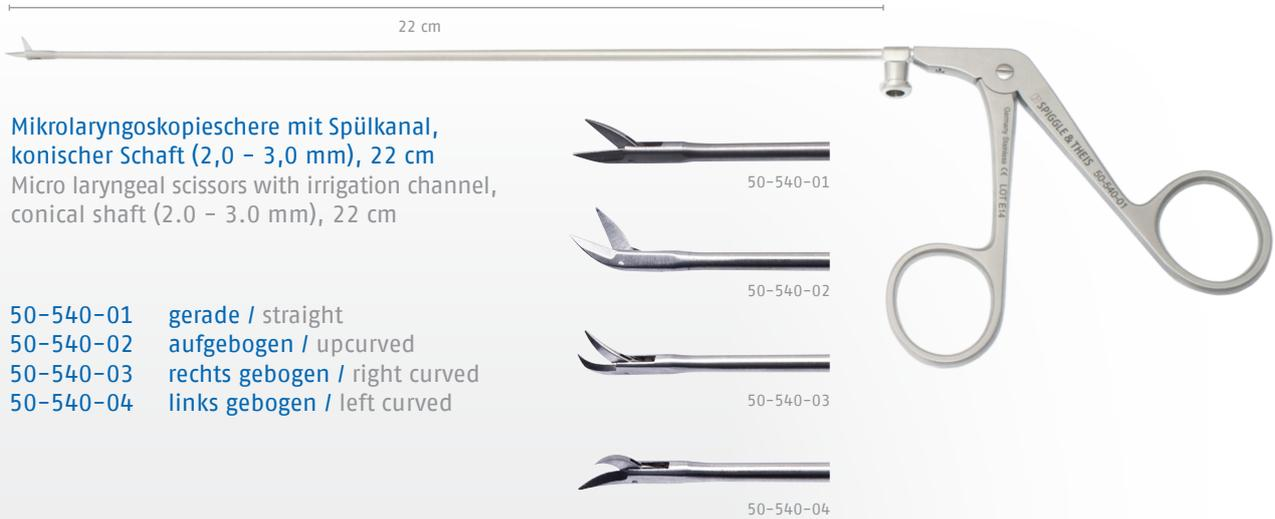



17 / 22 cm

Mikrolaryngoskopiezange mit Spülkanal, extra fein, Hechtmaul, 1,0 mm, konischer Schaft (1,0 - 2,0 mm)
 Micro laryngeal forceps with irrigation channel, very fine, alligator jaws, 1.0 mm, conical shaft (1.0 - 2.0 mm)

50-560-18	17 cm, gerade / straight		50-560-18
50-560-23	22 cm, gerade / straight		
50-561-18	17 cm, rechts gebogen / right curved		
50-561-23	22 cm, rechts gebogen / right curved		50-561-18
50-562-18	17 cm, links gebogen / left curved		
50-562-23	22 cm, links gebogen / left curved		50-562-18

17 / 22 cm

Mikrolaryngoskopieschere mit Spülkanal, extra fein, 1,0 mm, konischer Schaft (1,0 - 2,0 mm)
 Micro laryngeal scissors with irrigation channel, very fine, 1.0 mm, conical shaft (1.0 - 2.0 mm)

50-570-18	17 cm, gerade / straight		50-570-18
50-570-23	22 cm, gerade / straight		
50-571-18	17 cm, rechts gebogen / right curved		50-571-18
50-571-23	22 cm, rechts gebogen / right curved		
50-572-18	17 cm, links gebogen / left curved		50-572-18
50-572-23	22 cm, links gebogen / left curved		
50-573-18	18 cm, aufgebogen / upcurved		50-573-18
50-573-23	22 cm, aufgebogen / upcurved		

17 / 22 cm

Mikrolaryngoskopiezange mit Spülkanal, extra fein, Herzform, 1,0 mm, konischer Schaft (1,0 - 2,0 mm)
 Micro laryngeal forceps with irrigation channel, very fine, heartshaped jaw, 1.0 mm, conical shaft (1.0 - 2.0 mm)

50-580-18	17 cm, rechts gebogen / right curved		50-580-18
50-580-23	22 cm, rechts gebogen / right curved		
50-581-18	17 cm, links gebogen / left curved		50-581-18
50-581-23	22 cm, links gebogen / left curved		

Special Instruments

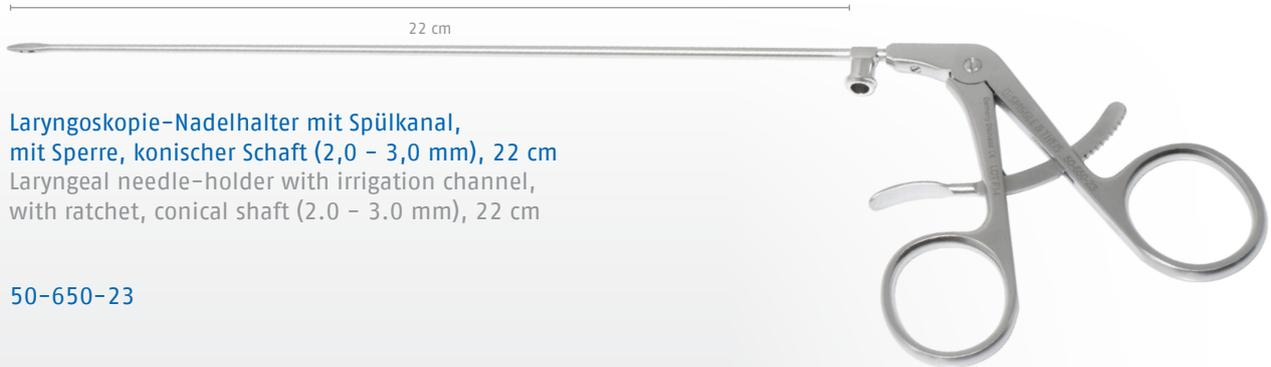

**Laryngoskopie-Nadelhalter mit Spülkanal,
mit Sperre, konischer Schaft (2,0 - 3,0 mm), 22 cm**
Laryngeal needle-holder with irrigation channel,
with ratchet, conical shaft (2.0 - 3.0 mm), 22 cm

50-650-23

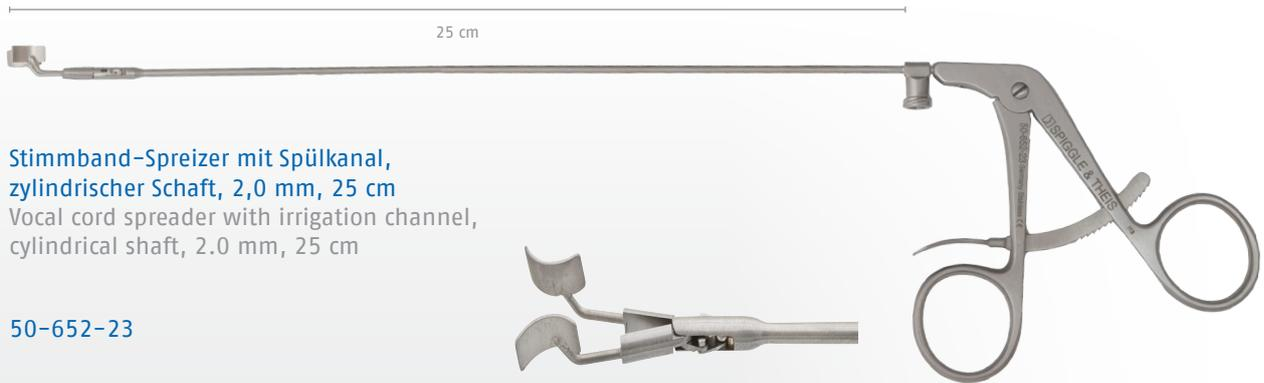

**Stimmband-Spreizer mit Spülkanal,
zylindrischer Schaft, 2,0 mm, 25 cm**
Vocal cord spreader with irrigation channel,
cylindrical shaft, 2.0 mm, 25 cm

50-652-23

Vorteile / Advantages

- **Integrierter Spülschaft für optimierte Reinigung** / Integrated irrigation channel for optimal cleaning
- **Konischer Schaft für hohe Stabilität und optimale Sicht** / Conical sheath for high stability and optimal view



Metallschale
Metal bowl

80-501-01	B1	Ø 4,0 cm	H=1,9 cm	20 ml
80-501-02	B2	Ø 6,0 cm	H=3,9 cm	60 ml
80-501-03	B3	Ø 8,5 cm	H=4,0 cm	160 ml
80-501-04	B4	Ø 11,0 cm	H=5,5 cm	400 ml



Medizinbecher, Edelstahl, graduert
Medicine cup, stainless steel, graduated

80-503-03	Ø 5,0 cm	H=2,5 cm	30 ml
80-504-05	Ø 5,3 cm	H=4,5 cm	50 ml



Lösungsschale, Edelstahl
Solution bowl, stainless steel

80-506-30	B1	Ø 10,0 cm	H=6,0 cm	300 ml
80-507-40	B2	Ø 12,0 cm	H=7,0 cm	400 ml
80-509-75	B3	Ø 15,0 cm	H=7,5 cm	750 ml



Tablettenschale, Edelstahl, Ø 6,5 cm, H=2 cm
Tablet dish, stainless steel, Ø 6.5 cm, H=2 cm

80-512-00



Petrirschale, Klarglas, mit Deckel
Petri bowl, clear glass, with lid

	Ø	Höhe / Height
80-515-06	6,0 cm	1,5 cm
80-515-08	8,0 cm	1,5 cm
80-515-10	15,0 cm	2,0 cm



Medikamenten-Schälchen, Glas, schwarz, mit Deckel, 4x4 cm
Medicine cup, glass, black, with lid, 4 x 4 cm

80-517-00

Miscellaneous



**Medikamenten-Schälchen,
Dappenglas, farbig, Ø 3,2 cm**
Medicine cup,
dappen-glass, coloured, Ø 3.2 cm

80-519-00 kristall / crystal
80-519-01 grün / green
80-519-02 rosa / pink
80-519-03 topas / topaz



Porzellan-Schälchen, rund, mit Ausguss
China bowl, round, with nozzle

	Ø
80-520-06	8,0 cm
80-520-08	10,0 cm



Nierenschale, Edelstahl
Kidney bowl, stainless steel

80-525-17	17,5 cm
80-525-25	25,0 cm



Kornzangen-Behälter, Edelstahl
Forceps holder, stainless steel

	Ø	Höhe / Height
80-528-13	5,0 cm	13,5 cm
80-528-18	5,0 cm	18,0 cm
80-528-20	9,5 cm	20,0 cm



**Kornzangen-Behälter,
Glas, Edelstahldeckel mit
Ausschnitt, Ø 8 cm, Höhe 20 cm**
Forceps holder,
glass, stainless steel lid with
opening, Ø 8 cm, height 20 cm

80-530-20



**Norm-Sterilisations-Container,
Normal-Boden, Ventil-Deckel mit Thermoloc,
Aluminium, Griff-Farbe nach Wahl**
Norm sterilisation container,
unperforated bottom, valve lid with thermoloc,
aluminium, handle color of your choice

80-630-12	29,6 x 27,5 x 12,0 cm
80-660-14	59,6 x 27,5 x 14,0 cm
80-660-21	59,6 x 27,5 x 21,0 cm



Siebkorb, Edelstahl-Drahtgeflecht, Fallgriffe
Basket, stainless-steel wire mesh, slide handles

80-670-25	24,5 x 24,5 x 6,0 cm
80-670-40	40,0 x 24,5 x 6,0 cm
80-670-49	48,5 x 24,5 x 6,0 cm



Codier-Schild, 6 x 2 cm, 20 Zeichen
Coding label, 6 x 2 cm, 20 characters

80-680-01	schwarz / black
80-680-02	rot / red
80-680-03	braun / brown
80-680-04	grün / green
80-680-05	gelb / yellow
80-680-06	lila / purple
80-680-07	blau / blue

Zubehör Accessories

- 80-683-00 **Container-Siegel, disposable, blau, 500 Stück/Box**
Container seal, disposable, blue, 500 pieces/box
- 80-684-00 **Indikator-Klebe-Etikett, Lasche rechts, 1000 Stück/Box**
Adhesive indicator label, latch right side, 1000 pieces/box
- 80-685-00 **Entsorgungsmarke, Edelstahl, zum Aufstecken, 2,5 x 3 cm, inclusive Gravur bis zu 5 Zeichen**
Clip on coding clamp, stainless steel, 2.5x3 cm, including engraving up to 5 characters
- 80-688-00 **Klemmschild aus Edelstahl, 6 x 4 cm, 25 Stück/Box**
Stainless steel label, 6 x 4 cm, 25 pieces/box

Sets

50-950-00 Laryngoskopie-Basisset

Laryngoscopy basic set

Bestehend aus / Consisting of:

- 50-101-00 **Bruststütze für Erwachsene, Ring 9 cm, Stützstange 34,5 cm /**
Chest support for adults, ring 9 cm, rod length 34.5 cm
- 50-200-05 **Operations-Laryngoskop, Gr. 5, für Männer, 17,2 cm, ID 15 mm, AD 29 x 19 mm /**
Surgical laryngoscope, size 5, for men, length 17.2 cm, ID 15 mm, OD 29 x 19 mm
- 50-200-03 **Operations-Laryngoskop, Gr. 3, für Jugendliche, 17,2 cm, ID 12 mm, AD 21 x 13 mm /**
Surgical laryngoscope, size 3, for juveniles, length 17.2 cm, ID 12 mm, OD 21 x 13 mm
- 50-202-04 **Operations-Laryngoskop, spreizbar, Gr.4, für Frauen, 17,2 cm, ID 14,5 mm, AD 27 x 15 mm /**
Surgical laryngoscope, spreadable, size 4, for women, 17.2 cm, ID 14.5 mm, OD 27 x 15 mm
- 50-205-36 **Fiberglas-Lichtträger für starre und spreizbare Laryngoskope Gr. 3-6 /**
Fiberglass lightcarrier for rigid and spreadable laryngoscopes size 3-6
- 50-240-00 **Endoragard Zahnschutz, doppelseitig /**
Endoragard teeth protector, double sided
- 50-300-00 **Kleinsasser Handgriff, gewinkelt /**
Kleinsasser handle, angled
- 50-311-23 **Sichelmesser, gebogene Schneide, Arbeitslänge 22 cm /**
Sickle knife, curved edge, working length 22 cm
- 50-312-23 **Messer, oval, gerade, Arbeitslänge 22 cm /**
Knife, oval, straight, working length 22 cm
- 50-315-23 **Messer, golfstockförmig, Arbeitslänge 23 cm /**
Knife, golfstick shaped, working length 23 cm
- 50-317-23 **Häkchen, stumpf, 90°, Arbeitslänge 22 cm /**
Hook, blunt, 90°, working length 22 cm
- 50-319-23 **Knotenführer, gerade, Arbeitslänge 23 cm /**
Knot tier, straight, working length 23 cm
- 50-347-20 **Saugrohr mit Unterbrecher, kniegebogen, seitr. distale Öffnung, 2,0 mm, 25 cm /**
Suction tube with interruptor, distal side opening, angled, 2.0 mm, 25 cm
- 50-353-23 **Injektionsnadel, bajonett, Arbeitslänge 23 cm /**
Injection needle, bayonet, working length 23 cm
- 80-014-45 **Monopolares Anschlusskabel für Instrumente, 4,5 m, passend für Sutter/Martin/Berchtold/Aesculap, autoklavierbar /**
Monopolar connecting cable for instruments, 4.5 m, compatible with Sutter/Martin/Berchtold/Aesculap, autoclavable
- 50-501-10 **Mikrolaryngoskopiezange, drehbar, runde Löffel, 2,0 mm, aufgebogen, mit Spülkanal, 23 cm /**
Microlaryngoscopy forceps, rotatable, round cups, upcurved, 2.0 mm, with irrigation channel, 23 cm
- 50-502-10 **Mikrolaryngoskopiezange, drehbar, Alligator, aufgebogen, mit Spülkanal, 23,5 cm /**
Microlaryngoscopy forceps, rotatable, alligator, upcurved, with irrigation channel, 23.5 cm
- 50-503-10 **Mikrolaryngoskopiezange, drehbar, dreieckiges Maul, aufgebogen, mit Spülkanal, 23 cm /**
Microlaryngoscopy forceps, rotatable, triangular tip, upcurved, with irrigation channel, 23 cm
- 50-504-10 **Mikrolaryngoskopieschere, drehbar, aufgebogen, mit Spülkanal, 23 cm /**
Microlaryngoscopy scissors, rotatable, upcurved, with irrigation channel, 23 cm
- 50-512-01 **Mikrolaryngoskopiezange mit Spülkanal, runde Löffel, 4,0 mm, gerade, 23 cm /**
Micro laryngeal forceps with irrigation channel, round cups, 4.0 mm, straight, 23 cm
- 50-650-23 **Laryngoskopie-Nadelhalter mit Spülkanal, mit Sperre, 22 cm /**
Laryngeal needle-holder with irrigation channel, with ratchet, 22 cm
- 50-550-23 **Mikrolaryngoskopiezange mit Spülkanal, extra fein, runde Löffel, 1,0mm, gerade, konischer Schaft, 22 cm /**
Micro laryngeal forceps with irrigation channel, very delicate, round cups, 1.0 mm, straight, conical shaft, 22 cm
- 50-560-23 **Mikrolaryngoskopiezange mit Spülkanal, extra fein, Hechtmaul, 1,0 mm, gerade, konischer Schaft, 22 cm /**
Micro laryngeal forceps with irrigation channel, very delicate, alligator jaw, 1.0 mm, straight, conical shaft, 22 cm
- 50-570-23 **Mikrolaryngoskopieschere mit Spülkanal, extra fein, 1,0 mm, gerade, konischer Schaft, 22 cm /**
Micro laryngeal scissors with irrigation channel, very delicate, 1.0 mm, straight, conical shaft, 22 cm



50-960-00 Laser-Set für Erwachsene

Laser set for adults

Bestehend aus / Consisting of:

- 50-215-05 **Laser-Laryngoskop Größe 5 für Männer /**
Laser laryngoscope size 5 for men
- 50-215-03 **Laser-Laryngoskop Größe 3 für Jugendliche /**
Laser laryngoscope size 3 for juveniles
- 50-217-36 **Fiberglas-Lichtträger für Laserlaryngoskope Größen 3-6 /**
Fiberglass lightcarrier for laser laryngoscopes sizes 3-6
- 50-218-17 **Rauchabsaugrohr für Laserlaryngoskope Größen 3-7 /**
Smoke evacuation tube for laser laryngoscopes sizes 3-7
- 50-240-00 **Endoragard Zahnschutz, doppelseitig /**
Endoragard teeth protector, double sided
- 50-347-20 **Saugrohr mit Unterbrecher, kniegebogen, seitlich distale Öffnung 2,0 mm, 25 cm /**
Suction tube with interruptor, angled, distal side opening 2.0 mm, 25 cm
- 50-349-30 **Saugrohr mit Unterbrecher, Spitze geschlossen, zwei seitliche Öffnungen von 3,0 mm, 25 cm /**
Suction tube with interruptor, tip closed, two side openings of 3.0 mm, 25 cm
- 80-008-45 **Monopolares Anschlusskabel für S&T Elektroden-Handgriffe, 4,5 m, passend für Erbe ICC/ACC/ Wolf/Storz, autoklavierbar /**
Unipolar connecting cable for S&T electrode handles, 4.5 m, compatible with Erbe ICC/ACC/ Wolf/Storz, autoclavable
- 80-501-01 **Metallschale B1, Ø 4,0 cm, Höhe 1,9 cm, 20 ml /**
Metal bowl B1, Ø 4.0 cm, height 1.9 cm, 20 ml

50-970-00 Laser-Set für Kinder

Laser set for children

Bestehend aus / Consisting of:

- 50-215-02 **Laser-Laryngoskop, Gr. 2, schwarz, für Kinder, 15,2 cm, ID 11 mm, AD 20,5 x 13 mm /**
Laser laryngoscope, size 2, black, for children, 15.2 cm, ID 11 mm, OD 20.5 x 13 mm
- 50-217-12 **Fiberglas-Lichtträger für Laser-Laryngoskope Gr. 1 und 2 /**
Fiberglass lightcarrier for laser laryngoscopes size 1 and 2
- 50-218-17 **Rauchabsaugrohr für Laserlaryngoskope Größen 3-7 /**
Smoke evacuation tube for laser laryngoscopes sizes 3-7
- 50-240-00 **Endoragard Zahnschutz, doppelseitig /**
Endoragard teeth protector, double sided
- 50-347-20 **Saugrohr mit Unterbrecher, kniegebogen, seitlich distale Öffnung 2,0 mm, 25 cm /**
Suction tube with interruptor, angled, distal side opening 2.0 mm, 25 cm
- 80-008-45 **Monopolares Anschlusskabel für S&T Elektroden-Handgriffe, 4,5 m, passend für Erbe ICC/ACC/ Wolf/Storz, autoklavierbar /**
Unipolar connecting cable for S&T electrode handles, 4.5 m, compatible with Erbe ICC/ACC/ Wolf/Storz, autoclavable
- 50-580-18 **Mikrolaryngoskopiezange mit Spülkanal, extra fein, Herzform, 1,0 mm, rechts gebogen, konischer Schaft, 17 cm /**
Micro laryngeal forceps with irrigation channel, very delicate, heartshaped jaw, 1.0 mm, right curved, conical shaft, 17 cm
- 50-581-18 **Mikrolaryngoskopiezange mit Spülkanal, extra fein, Herzform, 1,0 mm, links gebogen, konischer Schaft, 17 cm /**
Micro laryngeal forceps with irrigation channel, very delicate, heartshaped jaw, 1.0 mm, left curved, conical shaft, 17 cm
- 80-501-01 **Metallschale B1, Ø 4,0 cm, 20 ml, Höhe 1,9 cm, 20 ml /**
Metal bowl B1, Ø 4.0 cm, height 1.9 cm, 20 ml

Sets

50-980-00 Pädiatrisches Laryngoskopie-Basisset

Basic set for paediatric laryngoscopy

Bestehend aus / Consisting of:

- 50-101-00 **Bruststütze für Erwachsene, Ring 9 cm, Stützstange 34,5 cm /**
Chest support for adults, ring 9 cm, rod length 34.5 cm
- 50-101-10 **Stützstange für Bruststütze, Ring 9 cm, 24 cm, für Kinder /**
Rod for chest support, ring 9 cm, 24 cm, for children
- 50-215-01 **Laser-Laryngoskop, Gr. 1, schwarz, für Kleinkinder, 13,5 cm, ID 11 mm, AD 20 x 12 mm /**
Laser laryngoscope, size 1, black, for small children, 13.5 cm, ID 11 mm, OD 20 x 12 mm
- 50-215-02 **Laser-Laryngoskop, Gr. 2, schwarz, für Kinder, 15,2 cm, ID 11 mm, AD 20,5 x 13 mm /**
Laser laryngoscope, size 2, black, for children, 15.2 cm, ID 11 mm, OD 20.5 x 13 mm
- 50-217-12 **Fiberglas-Lichtträger für Laser-Laryngoskope Gr. 1 und 2 /**
Fiberglass lightcarrier for laser laryngoscopes size 1 and 2
- 50-240-00 **Endoragard Zahnschutz, doppelseitig /**
Endoragard teeth protector, double sided
- 50-300-00 **Kleinsasser Handgriff, gewinkelt /**
Kleinsasser handle, angled
- 50-311-23 **Sichelmesser, gebogene Schneide, Arbeitslänge 22 cm /**
Sickle knife, curved edge, working length 22 cm
- 50-318-23 **Häkchen, scharf, retrograd, Arbeitslänge 23 cm, Gesamtlänge 25 cm /**
Hook, sharp, backwards, working length 23 cm, total length 25 cm
- 50-347-20 **Saugrohr mit Unterbrecher, kniegebogen, seitr. distale Öffnung, 2,0 mm, 25 cm /**
Suction tube with interruptor, distal side opening, angled, 2.0 mm, 25 cm
- 50-551-23 **Mikrolaryngoskopiezange mit Spülkanal, extra fein, runde Löffel, 1,0 mm, rechts gebogen, konischer Schaft, 22 cm /**
Micro laryngeal forceps with irrigation channel, very delicate, round cups, 1.0 mm, right curved, conical shaft, 22 cm
- 50-552-23 **Mikrolaryngoskopiezange mit Spülkanal, extra fein, runde Löffel, 1,0 mm, links gebogen, konischer Schaft, 22 cm /**
Micro laryngeal forceps with irrigation channel, very delicate, round cups, 1.0 mm, left curved, conical shaft, 22 cm
- 50-571-23 **Mikrolaryngoskopieschere mit Spülkanal, extra fein, 1,0 mm, rechts gebogen, konischer Schaft, 22 cm /**
Micro laryngeal scissors with irrigation channel, very delicate, 1.0 mm, right curved, conical shaft, 22 cm
- 50-572-23 **Mikrolaryngoskopieschere mit Spülkanal, extra fein, 1,0 mm, links gebogen, konischer Schaft, 22 cm /**
Micro laryngeal scissors with irrigation channel, very delicate, 1.0 mm, left curved, conical shaft, 22 cm
- 50-580-23 **Mikrolaryngoskopiezange mit Spülkanal, extra fein, Herzform, 1,0 mm, rechts gebogen, konischer Schaft, 22 cm /**
Micro laryngeal forceps with irrigation channel, very delicate, heartshaped jaw, 1.0 mm, right curved, conical shaft, 23 cm
- 50-581-23 **Mikrolaryngoskopiezange mit Spülkanal, extra fein, Herzform, 1,0 mm, links gebogen, konischer Schaft, 22 cm /**
Micro laryngeal forceps with irrigation channel, very delicate, heartshaped jaw, 1.0 mm, left curved, conical shaft, 23 cm
- 50-550-18 **Mikrolaryngoskopiezange mit Spülkanal, extra fein, runde Löffel, 1,0 mm, gerade, konischer Schaft, 17 cm /**
Micro laryngeal forceps with irrigation channel, very delicate, round cups, 1.0 mm, straight, conical shaft, 17 cm
- 50-580-18 **Mikrolaryngoskopiezange mit Spülkanal, extra fein, Herzform, 1,0 mm, rechts gebogen, konischer Schaft, 17 cm /**
Micro laryngeal forceps with irrigation channel, very delicate, heartshaped jaw, 1.0 mm, right curved, conical shaft, 17 cm
- 50-581-18 **Mikrolaryngoskopiezange mit Spülkanal, extra fein, Herzform, 1,0 mm, links gebogen, konischer Schaft, 17 cm /**
Micro laryngeal forceps with irrigation channel, very delicate, heartshaped jaw, 1.0 mm, left curved, conical shaft, 17 cm



Bipolare Koagulationselektrode	16	Angled endoscope HD	6
Bipolares Anschlusskabel	18	Adhesive indicator label	27
Bruststütze	5	Basic set for paediatric laryngoscopy	30
Codier-Schild	27	Basket	27
Container-Siegel	27	Bipolar coagulation electrode	16
Endoragard Zahnschutz	12	Bipolar coagulation cable	18
Entsorgungsmarke	27	Chest support	5
Fiberglas-Lichtträger	9, 11	China bowl	26
Heermann Handgriff	13	Clip on coding clamp	27
Holinger Laryngoskop	11	Coagulation suction tube	16
Häkchen	14	Coding label	27
Indikator-Klebe-Etikett	28	Container seal	27
Inject-Timer-Kanüle	9, 11	Cotton carrier	15
Injektionsnadel	15	Endoragard teeth protector	12
Jackson Laryngoskop	11	Fiberglass lightcarrier	9, 11
Kleinsasser Handgriff	13	Forceps holder	26
Klemmschild	27	Heermann handle	13
Knotenführer	14	Holinger Laryngoscope	11
Koagulations Saugrohr	16	Hook	14
Kornzangen-Behälter	26	Inject-Timer cannula	9, 11
Laryngoskopie-Basisset	28	Injection needle	15
Laryngoskopie-Nadelhalter	24	Jackson Laryngoscope	11
Laser-Laryngoskop	10	Kidney bowl	26
Laser-Sets	29	Kleinsasser handle	13
Lösungsschale	25	Knives	13, 14
Medasil Zahnschutz	12	Knot tier	14
Medikamenten-Schälchen	25, 26	Laryngeal needle-holder	24
Medizinbecher	25	Laryngoscopy Basic Set	28
Messer	13, 14	Laser laryngoscope	10
Metallschale	25	Laser Sets	29
Mikrolaryngoskopieschere mit Spülkanal ..	19, 22, 23	Medasil teeth protector	12
Mikrolaryngoskopiezange, drehbar	19	Medicine cup	25, 26
Mikrolaryngoskopiezange mit Spülkanal ..	19, 22, 23	Metal bowl	25
Monopolare Koagulationszange	17	Micro laryngeal forceps, rotatable	19
Monopolares Anschlusskabel	18	Micro laryngeal forceps w. irrigation channel	19-23
Monopolares Koagulations-Saugrohr	16	Micro laryngeal scissors w. irrigation channel ..	19 22 23
Nierenschale	26	Norm sterilisation container	27
Norm-Sterilisations-Container	27	Petri bowl	25
Operations-Laryngoskop	7, 8	Probe	14
Pädiatrisches Laryngoskopie-Basisset	30	Stainless steel label	27
Petrirschale	25	Solution bowl	25
Porzellan-Schälchen	26	Sickle knife	13
Rauchabsaugrohr	9, 11	Smoke evacuation tube	10, 11
Saugraspatorium	15	Surgical laryngoscope	7, 8
Saugrohr	15	Suction raspatory	15
Siebkorb	27	Suction tube	15
Sichelmesser	13	Suture needle	14
Stimmband-Spreizer	24	Tablet dish	25
Sonde	14	Teeth protector, metal	12
Tablettenschale	25	Unipolar coagulation cable	18
Umstechungsnadel	14	Unipolar coagulation forceps	17
Videolaryngoskop	6	Unipolar coagulation suction tube	16
Watteträger	15	Vocal cord spreader	24
Winkeloptik HD	6	Video laryngoscope	6
Zahnschutz aus Metall	12		



Numeric Index

10-722-13	13	50-347-25	15	80-015-45	18
50-101-00	5	50-347-30	15	80-016-30	18
50-101-10	5	50-349-30	15	80-016-50	18
50-101-20	5	50-351-23	15	80-017-30	18
50-101-30	5	50-353-23	15	80-017-50	18
50-101-40	5	50-365-27	16	80-018-30	18
50-150-00	6	50-400-23	17	80-018-50	18
50-155-00	6	50-402-23	17	80-019-30	18
50-200-01	7	50-404-23	17	80-019-50	18
50-200-02	7	50-406-23	17	80-061-26	16
50-200-03	7	50-501-10	19	80-062-26	16
50-200-04	7	50-502-10	19	80-063-30	16
50-200-05	7	50-503-10	19	80-501-01	25
50-200-06	7	50-504-10	19	80-501-02	25
50-200-07	7	50-510-01	20	80-501-03	25
50-200-08	7	50-510-02	20	80-501-04	25
50-202-01	8	50-510-03	20	80-503-03	25
50-202-02	8	50-510-04	20	80-504-05	25
50-202-03	8	50-510-05	20	80-506-30	25
50-202-04	8	50-510-06	20	80-507-40	25
50-202-05	8	50-512-01	20	80-509-75	25
50-202-06	8	50-512-02	20	80-515-06	25
50-202-07	8	50-512-03	20	80-515-08	25
50-205-12	9	50-512-04	20	80-515-10	25
50-205-36	9	50-514-00	21	80-517-00	25
50-205-70	9	50-520-01	21	80-519-00	26
50-207-17	9	50-520-02	21	80-519-01	26
50-209-17	9	50-520-03	21	80-519-02	26
50-215-01	10	50-520-04	21	80-519-03	26
50-215-02	10	50-530-01	21	80-520-06	26
50-215-03	10	50-530-02	21	80-520-08	26
50-215-04	10	50-530-03	21	80-525-17	26
50-215-05	10	50-540-01	22	80-525-25	26
50-215-06	10	50-540-02	22	80-528-13	26
50-215-07	10	50-540-03	22	80-528-18	26
50-217-12	11	50-540-04	22	80-528-20	26
50-217-36	11	50-550-18	22	80-530-20	26
50-217-70	11	50-550-23	22	80-630-12	27
50-218-17	11	50-551-18	22	80-660-14	27
50-219-17	11	50-551-23	22	80-660-21	27
50-230-01	11	50-552-18	22	80-670-25	27
50-230-02	11	50-552-23	22	80-670-40	27
50-230-03	11	50-553-18	22	80-670-49	27
50-232-23	14	50-553-23	22	80-680-01	27
50-233-01	11	50-560-18	23	80-680-02	27
50-233-02	11	50-560-23	23	80-680-03	27
50-233-03	11	50-561-18	23	80-680-04	27
50-240-00	12	50-561-23	23	80-680-05	27
50-245-00	12	50-562-18	23	80-680-06	27
50-245-01	12	50-562-23	23	80-680-07	27
50-245-02	12	50-570-18	23	80-683-00	27
50-245-03	12	50-570-23	23	80-684-00	27
50-250-00	12	50-571-18	23	80-685-00	27
50-300-00	13	50-571-23	23	80-688-00	27
50-310-23	13	50-572-18	23		
50-311-23	13	50-572-23	23		
50-312-23	13	50-573-18	23		
50-313-23	13	50-573-23	23		
50-315-23	14	50-580-18	23		
50-316-23	14	50-580-23	23		
50-317-23	14	50-581-18	23		
50-318-23	14	50-581-23	23		
50-319-23	14	50-650-23	24		
50-320-23	14	50-652-23	24		
50-321-23	14	50-950-00	28		
50-322-23	15	50-960-00	29		
50-330-40	9	50-970-00	29		
50-345-23	15	50-980-00	30		
50-347-20	15	80-014-45	18		











Deutsch



International

Spiggle & Theis Medizintechnik GmbH ist auch über Mobilgeräte wie Smartphones und Tablet-PCs erreichbar – einfach QR-Code scannen!
Spiggle & Theis Medizintechnik GmbH is also available for mobile devices like smart phones and tablet PC – simply scan QR code!

SPIGGLE & THEIS

Medizintechnik GmbH

Burghof 14

51491 Overath / Germany

Tel.: +49 (0) 2206 / 90 81 - 0

Fax: +49 (0) 2206 / 90 81 -13

info@spiggle-theis.de

www.spiggle-theis.de

www.spiggle-theis.com

© 2016 by Spiggle & Theis Medizintechnik GmbH

Änderungen und Druckfehler – auch für Bilder – vorbehalten.

Bitte beachten Sie auch, dass ggf. nicht alle Produkte in Ihrem Land vertrieben werden.

Modifications and errors – including pictures – reserved.

Please note also that not all goods might be for sale in your country.