



**DINA - HITEX<sup>®</sup>**

**BARRIER SYSTEM FOR SURGICAL THEATRES  
DISPOSABLE CLOTHING FOR HOSPITALS**

**Product Catalogue**  
Medical disposable products



# DINA - HITEX<sup>®</sup>



## Contents

### BARRIER SYSTEM FOR SURGICAL THEATRES

#### Introduction

page

Basic Data	2
Dina-Hitex's Used Materials	5

#### Sterile Surgical Drapes and Sets

Basic Drapes	6
General Surgery	8
Orthopaedy	11
Cardiovascular Surgery	16
Urology	20
Gynaecology	22
Delivery and Newborn Sets	25
Ophthalmology	27
Dentistry	30
ORL	32
Neurosurgery	34

#### Set Accessories

Surgical Covers and Accessories	36
Device Covers	38
Fluid Collection Pouches	40
Surgical Gowns	42

#### DISPOSABLE CLOTHING FOR HOSPITALS

Surgical Face Masks	43
Head Covers	44
Hygienic and Protective Clothing	47
Hygienic Sheets, Bed Sheets and Bedding Sets	51
Other Non-Sterile Products	53

# **DINA - HITEX®**

We are a reliable provider of single use medical devices, based in Central Europe.

Dina-Hitex products have been designed to make work of surgeons and hospital staff comfortable and safe, ensuring maximal protection for both healthcare workers and patients. Our comprehensive product portfolio reflects wide needs of customers and is a result of a systematic work with doctors and medical specialists.

Dina-Hitex core business is a production of highly specialised surgical drapes and customised procedure sets which are developed according to the customers' needs. Dina-Hitex's drapes and sets can be distinguished from others by its precision and quality for a reasonable price.

We have been on the Czech and European market since 1992. The local Czech market is covered by a net of sales representatives, while in Slovakia and Poland there are branch offices. Recently we have launched new production plants in India and Tunisia to bring European quality products over there as well.

## Basic facts:

- **Portfolio of 39 000 products**
- **Active in 35 countries on 3 continents**
- **750 employees**
- **Clean room area 2 500 m<sup>2</sup>**
- **Total premises 8 000 m<sup>2</sup>**
- **In-house: material lamination  
laboratory  
adhesive tapes production  
device covers production  
ETO sterilisation unit**



## **DINA - HITEX®**

**DINA-HITEX, spol.s r.o.**

Ždánská 987  
685 01 Bučovice, Czech Republic  
Tel.reception +420 517 380 820  
Tel.orders Czech Republic +420 517 324 503  
Tel.orders other countries +420 517 324 504  
E-mail: [info@dina-hitex.com](mailto:info@dina-hitex.com)  
[www.dina-hitex.com](http://www.dina-hitex.com)

**DINA-HITEX SK, spol.s r.o.**

ul. MUDr. A. Chúru 2905/1  
911 01 Trenčín, Slovak Republic  
Tel./Fax +421 327 446 076  
Mobile +421 918 628 020  
E-mail: [dinahitex@mail.t-com.sk](mailto:dinahitex@mail.t-com.sk)  
[www.dina-hitex.com](http://www.dina-hitex.com)

**DINA-HITEX Sp. z o.o.**

Ul. Gen.Boruty Spiechowicza 27  
43-300 Bielsko-Biała, Poland  
Tel. +4833 4706 811  
Fax +4833 8129 628  
E-mail: [dinahitex@gmail.com](mailto:dinahitex@gmail.com)  
[www.dina-hitex.com](http://www.dina-hitex.com)



**Dina International, ZAO**

2, bld.1, Odesskaya str  
Moscow, 117 638, Russian Federation  
E-mail: [medisp@dinaint.com](mailto:medisp@dinaint.com)  
[www.dinaint.com](http://www.dinaint.com)

## **MEDIKA - HITEX®**

**MEDIKA-HITEX**

route oueslatia avenue  
de l'environnement Zone Industrielle  
Kairouan, Tunisia  
Tel. +21677275444 / +21671138458  
Fax +21677275445 / +21671860774  
E-mail: [contact@medika-hitex.com](mailto:contact@medika-hitex.com)  
[www.medika-hitex.com](http://www.medika-hitex.com)

## **HITEX Healthcare**

**HITEX-HEALTHCARE**

Village Nangal Khurd  
Tehsil: Haroli, Distt. Una-174 705  
Himachal Pradesh, India  
Tel. +91 99201 34928  
E-mail: [info@hitexhealthcare.com](mailto:info@hitexhealthcare.com)  
[www.hitexhealthcare.com](http://www.hitexhealthcare.com)

DINA-HITEX Barrier system is a complex system developed to minimize risk of infection during surgery and at the same time actively improves the work efficiency in surgical theatres.

We offer wide portfolio of products from simple drapes to a complex system protecting patients, staff and medical equipment.

**Dina-Hitex drapes** are designed to maximally meet all required standards of a particular invasive operation. They are made of functional materials and with regards to the specific surgery, they can be combined with other medical devices.

To maximise advantages of our products and to ease the work of surgeons and nurses, we recommend to use drapes as a part of **Dina-Hitex sterile surgical sets**.

- Dina-Hitex sterile surgical sets:**
- ready to use at surgical theatres
  - save time and make work more comfortable
  - ensure maximal protection

### Did you find what you needed?

This catalogue presents our standard products. Nevertheless, we can develop a drape or set just for you. Let us know your specific requirements and we will design a customised product that you need.



## Key to Dina-Hitex used materials

### 2-ply laminated material

PF2	absorbent tissue	20g/m <sup>2</sup> + PE foil 25µm
FS2	hydrophilic spunbond	17g/m <sup>2</sup> + PE foil 25µm
2SBL	hydrophilic spunbond	30g/m <sup>2</sup> + PE foil 25µm
DS2	absorbent viscose	28g/m <sup>2</sup> + PE foil 25µm

### 3-ply laminated material

FS3	hydrophilic spunbond	17g/m <sup>2</sup> + PE foil 25µm + hydrophobic spunbond 17g/m <sup>2</sup>
DS3	absorbent viscose	28g/m <sup>2</sup> + PE foil 25µm + hydrophobic spunbond 17g/m <sup>2</sup>
DS2 lam	absorbent viscose	28g/m <sup>2</sup> + airlaid 60g/m <sup>2</sup> + PE foil 25µm
3SBL lam	absorbent viscose	28g/m <sup>2</sup> + viscose & PES 50g/m <sup>2</sup> + PE foil 25µm
FSM	hydrophilic spunbond + absorbent MB	80g/m <sup>2</sup> + PE foil 25µm

### 2-ply material

SPUNLACE	hydrophobic material, 70g/m <sup>2</sup> , Cellulose 38g/m <sup>2</sup> + PES 32g/m <sup>2</sup>
SM	hydrophilic spunbond + absorbent MB, 80g/m <sup>2</sup>

### 3-ply material

SMS	hydrophobic antistatic 100% PP, 35g/m <sup>2</sup>	SB+MB+SB
SMMM	hydrophobic antistatic 100% PP, 43 or 50g/m <sup>2</sup>	SB+3xMB+SB

MB	melt blown
PE	polyethylene
PP	polypropylene
SB	spunbond
PES	polyester
PU	polyurethane
Vis	viscose
AT	adhesive tape
IF	incise foil

## Basic Drapes

## Basic Drapes

Dina-Hitex drapes are available in various sizes, materials and apertures.

### Simple Drapes

May be used as table covers or wrapping sheets.

Size (cm)	Ref SMS	Ref DS2	Ref DS3	Ref 2SBL	Ref FS2	Ref FS3	Ref PF2
34 x 34		20-0169-S					
50 x 50	10-0101-S	20-0101-S	30-0101-S	51701-S	11-0101-S	22-0101-S	25-0101-S
50 x 70	10-0102-S	20-0102-S	30-0102-S	51702-S	11-0102-S	22-0102-S	25-0102-S
75 x 75	10-0103-S	20-0103-S	30-0103-S	51703-S	11-0103-S	22-0103-S	25-0103-S
75 x 90	10-0104-S	20-0104-S	30-0104-S	51704-S	11-0104-S	22-0104-S	25-0104-S
100 x 120	10-0132-S	20-0132-S	30-0132-S	51717-S	11-0132-S	22-0132-S	25-0232-S
150 x 180	10-0106-S	20-0106-S	30-0106-S	51783-S	11-0106-S	22-0106-S	25-0106-S
200 x 240	10-0133-S	20-0133-S	30-0133-S	51721-S	11-0133-S	22-0133-S	*

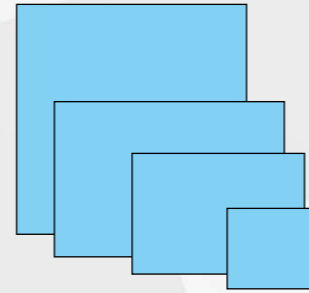

\* PF2 max possible size 150 x 240 cm

### Surgical Drapes with AT on the Edge

Maximum length of AT is defined by the length of the drape edge.

Size (cm)	AT (cm)	Ref SMS	Ref DS2	Ref DS3	Ref 2SBL	Ref FS2	Ref FS3	Ref PF2
50 x 50	50	10-0201-S	20-0201-S	30-0201-S	51772-S	11-0201-S	22-0201-S	25-0201-S
50 x 70	70	10-0202-S	20-0202-S	30-0202-S	51752-S	11-0202-S	22-0202-S	25-0202-S
75 x 75	75	10-0203-S	20-0203-S	30-0203-S	51742-S	11-0203-S	22-0203-S	25-0203-S
75 x 90	90	10-0204-S	20-0204-S	30-0204-S	51735-S	11-0204-S	22-0204-S	25-0204-S
100 x 120	120	10-0232-S	20-0232-S	30-0232-S	51740-S	11-0232-S	22-0232-S	25-0232-S
150 x 180	80	10-0206-S	20-0206-S	30-0206-S	51812-S	11-0206-S	22-0206-S	25-0206-S
200 x 240	80	10-0233-S	20-0233-S	30-0233-S	51738-S	11-0233-S	22-0233-S	*

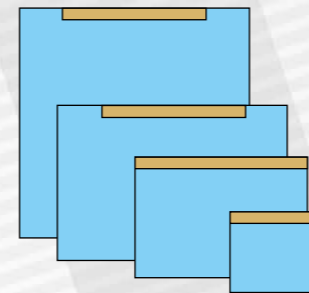

\* PF2 max size 150 x 240 cm

### Surgical Drapes with Aperture

Apertures may be usually of either round, oval, square, rectangular, diamond or pentagon shape.

Size (cm)	Aperture Size (cm)	Aperture Shape	Ref DS2	Ref DS3	Ref 2SBL	Ref FS2	Ref FS3
50 x 70	7	round	20-0301-S	30-0301-S	15-0311-S	11-0301-S	22-0301-S
50 x 70	10	round	20-0302-S	30-0302-S	15-0312-S	11-0309-S	22-0302-S
75 x 90	7	round	20-0303-S	30-0303-S	15-0305-S	11-0303-S	22-0303-S
75 x 90	10	round	20-0304-S	30-0304-S	15-0317-S	11-0316-S	22-0304-S
75 x 110	10	round	20-0305-S	30-0305-S	15-0315-S	11-0305-S	22-0305-S
50 x 50	6 x 8	oval	20-0308-S	30-0308-S	15-0303-S	11-0308-S	22-0308-S
50 x 70	6 x 8	oval	20-0314-S	30-0314-S	15-0314-S	11-0314-S	22-0314-S
100 x 150	6 x 8	oval	20-0306-S	30-0306-S	15-0316-S	11-0306-S	22-0306-S
160 x 200	12	round	20-0366-S				

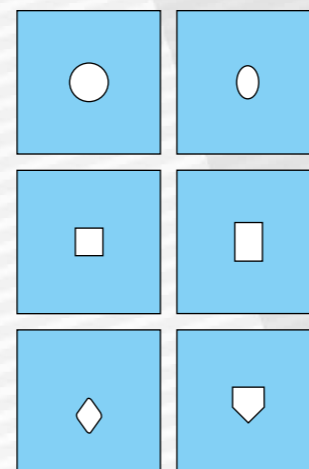

### Surgical Drapes with Adhesive Aperture

The adhesive area is made by AT placed around the aperture.

Size (cm)	Aperture Size (cm)	Aperture Shape	Ref DS2	Ref DS3	Ref 2SBL	Ref FS2	Ref FS3
50 x 70	7	round	20-0401-S	30-0401-S	15-0403-S	11-0401-S	22-0401-S
50 x 70	10	round	20-0402-S	30-0402-S	15-0404-S	11-0422-S	22-0402-S
75 x 90	7	round	20-0403-S	30-0403-S	15-0419-S	11-0403-S	22-0403-S
75 x 90	10	round	20-0404-S	30-0404-S	15-0409-S	11-0404-S	22-0404-S
75 x 110	10	round	20-0405-S	30-0405-S	15-0420-S	11-0423-S	22-0405-S
90 x 120	7	round	20-0422-S	30-0406-S	15-0421-S	11-0406-S	22-0406-S
120 x 150	10	round	20-0407-S	30-0407-S	15-0422-S	11-0407-S	22-0407-S
45 x 75	7	round	20-0409-S	30-0409-S	15-0423-S	11-0409-S	22-0409-S
150 x 200	7	round	20-0446-S	30-0446-S	15-0424-S	11-0424-S	22-0424-S
34 x 34	10	round	20-0512-S				
2 x (34 x 34) (2 part drape)	2 x (6 x 8)	2 x U	20-0513-S				

Aperture options

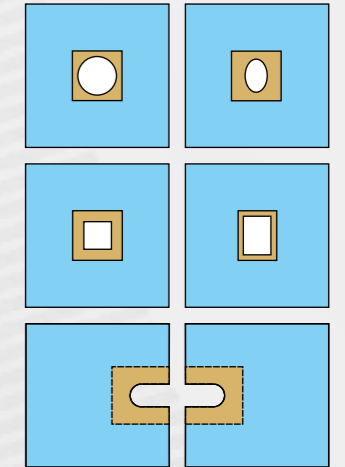

### Cannular and Catheterisation Drapes

Drapes with aperture and radial perforation made of either laminated DS2 or transparent PE.

Size (cm)	Aperture Size (cm)	Accessories	Ref DS2	Ref PE	Item
75 x 100	10	AT	501-005-S	-	Cannular drape
75 x 90	10	-	701-181-S	701-185-S	Drape with aperture
90 x 120	10	-	701-188-S	701-192-S	
120 x 150	10	-	701-195-S	-	
75 x 90	10	AT	701-182-S	701-186-S	Drape with adhesive aperture
90 x 120	10	AT	701-189-S	701-193-S	
120 x 150	10	AT	701-196-S	-	Drape with PE and adhesive aperture
75 x 90	10	PE+AT	701-183-S	-	
90 x 120	10	PE+AT	701-190-S	-	Drape with adhesive aperture and adhesive edge
120 x 150	10	PE+AT	701-197-S	-	
75 x 90	10	AT+AT	701-184-S	701-187-S	Drape with adhesive aperture and adhesive edge
90 x 120	10	AT+AT	701-191-S	701-194-S	
120 x 150	10	AT+AT	701-198-S	-	

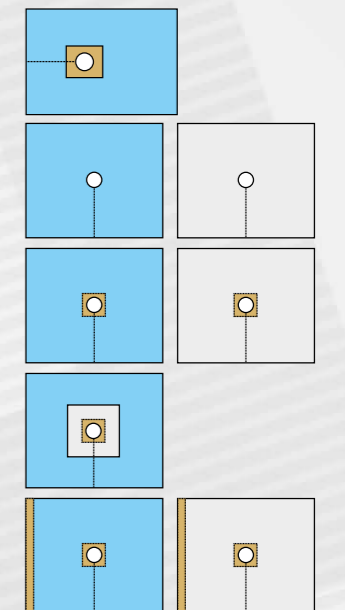

### Absorbent Surgical Table Covers

Size (cm)	Material	Reinforcement (cm)	Code	Item
100 x 220	FS2	SM-M	50891	Super absorbent table cover
140 x 220	FS2	SM-M	50892	Super absorbent table cover
100 x 240	SMS35g	FSM80	50894	Absorbent table cover
140 x 240	SMS35g	FSM80	50895	Absorbent table cover

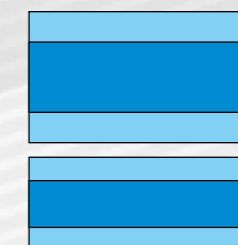

## General Surgery

### Universal Set Small 102-214-S

Component	Material	Size (cm)	Pcs
Instruments table drape	FS2	100 x 120	1
Surgical drape with adhesive edge	2SBL	150 x 180	2
Surgical drape with adhesive edge	2SBL	75 x 90	2

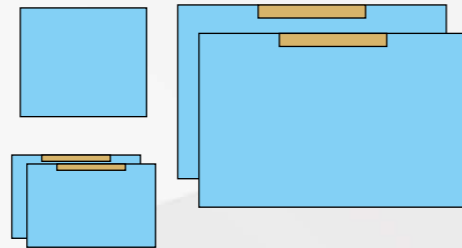

### Universal Set Large 102-174-S Universal Set Large ECO 102-198-S

Component	Material 102-174-S	Material 102-198-S	Size (cm)	Pcs
Instruments table drape	2SBL	FS2	150 x 180	1
Surgical drape with adhesive edge	2SBL	FS2	150 x 240	1
Surgical drape with adhesive edge	2SBL	FS2	150 x 175	1
Surgical drape with adhesive edge	2SBL	FS2	80 x 95	2
OP tape	AT+Vis	AT+Vis	10 x 50	1
Absorbent towel	Airlaid cellulose	Airlaid cellulose	30 x 33	4
MAYO cover	PE/SB28	PE/SB28	80 x 145 / 50 x 145	1

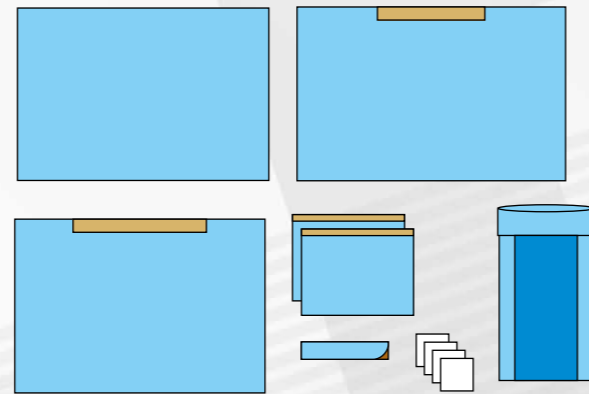

## BARRIER SYSTEM FOR SURGICAL THEATRES Sterile Surgical Drapes and Sets

## General Surgery

Laparotomy drape with AT edge and IF.

Code	101-116-S
Material	DS3
Size (cm)	240 x 320
Reinforcement (cm)	
Aperture (cm)	25 x 30
Accessories	IF, AT

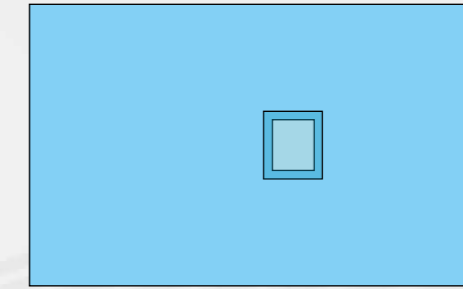

Laparotomy drape, reinforced, with AT edge and IF, short-term surgeries.

Code	101-110-S
Material	2SBL
Size (cm)	200 x 320
Reinforcement (cm)	Vis28 100 x 150
Aperture (cm)	25 x 30
Accessories	IF, AT

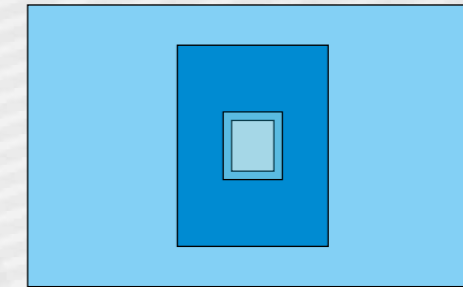

Laparoscopy drape, reinforced, with IF and leggings.

Code	105-130-S
Material	SMS
Size (cm)	260 x 280
Reinforcement (cm)	DS2 80 x 150
Aperture (cm)	25 x 30
Accessories	IF, leggings

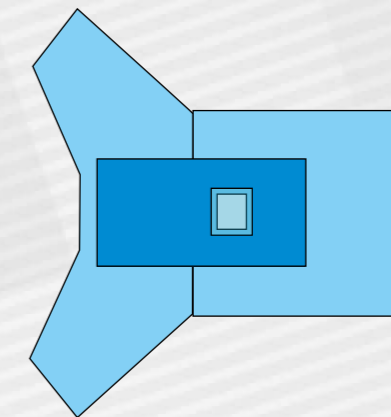

Laparotomy drape with IF, short-term surgeries.

Code	101-207-S
Material	FS2
Size (cm)	200 x 320
Reinforcement (cm)	
Aperture (cm)	25 x 30
Accessories	IF

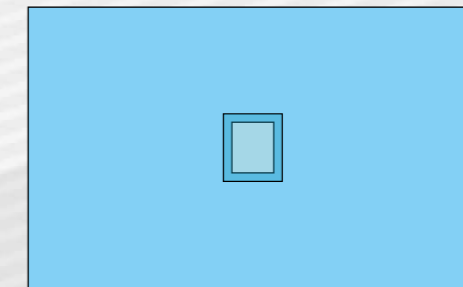

Laparotomy drape with adhesive aperture, short-term surgeries.

Code	101-208-S
Material	FS2
Size (cm)	200 x 320
Reinforcement (cm)	
Aperture (cm)	25 x 30
Accessories	AT

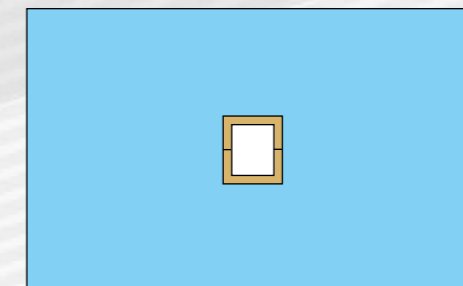

## General Surgery

### Laparoscopy Set 105-131-S

Component	Material	Size (cm)	Pcs
Wrapping sheet	FS2	75 x 80	1
Instruments table drape	2SBL	150 x 200	1
Absorbent towel	Airlaid cellulose	30 x 33	2
MAYO cover	PE/SB28	80 x 145/50 x 145	1
Laparoscopy drape with IF and leggings	SMS+DS2	260 x 280	1
Camera cover	PE	14 x 250	1
OP tape	AT+Vis	10 x 50	1
Dinafix	Velcro	2,5 x 20	1

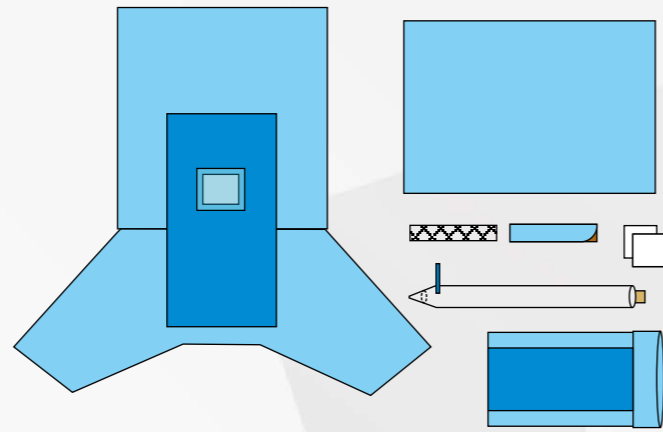

### Laparoscopy Set I ECO 105-164-S

Component	Material	Size (cm)	Pcs
Wrapping sheet	FS2	75 x 80	1
Instruments table drape	FS2	150 x 180	1
Laparotomy drape with IF	FS2	200 x 320	1
MAYO cover	PE/SB28	80 x 145/50 x 145	1
Absorbent towel	Airlaid cellulose	30 x 33	4

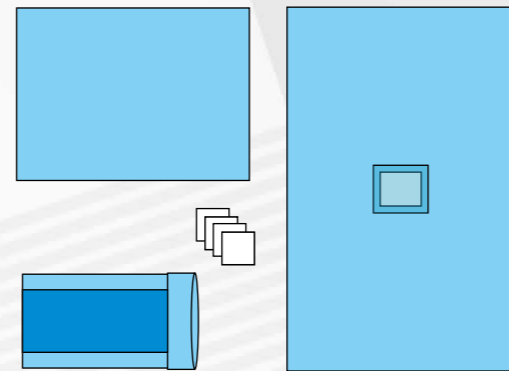

### Laparoscopy Set II ECO 105-165-S

Component	Material	Size (cm)	Pcs
Wrapping sheet	FS2	75 x 80	1
Instruments table drape	FS2	150 x 180	1
Laparotomy drape with adhesive aperture	FS2	200 x 320	1
MAYO cover	PE/SB28	80 x 145/50 x 145	1
Absorbent towel	Airlaid cellulose	30 x 33	4

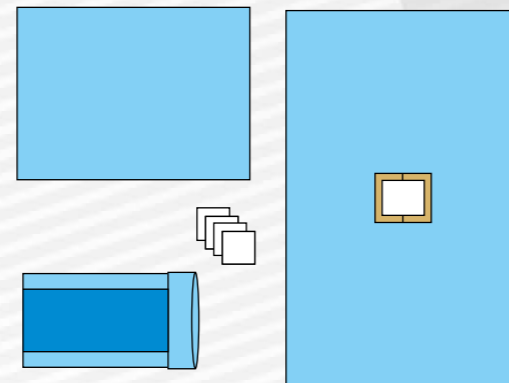

### Laparotomy Set 101-135-S

Component	Material	Size (cm)	Pcs
Wrapping sheet	FS2	75 x 80	1
Instruments table drape	2SBL	150 x 200	1
Dinafix	Velcro	2,5 x 20	1
OP tape	AT+Vis28	10 x 50	1
Laparotomy drape with IF and Adhesive edge	DS3	240 x 320	1
MAYO cover	PE/SB28	80 x 145/50 x 145	1
Absorbent towel	Airlaid cellulose	30x33	4

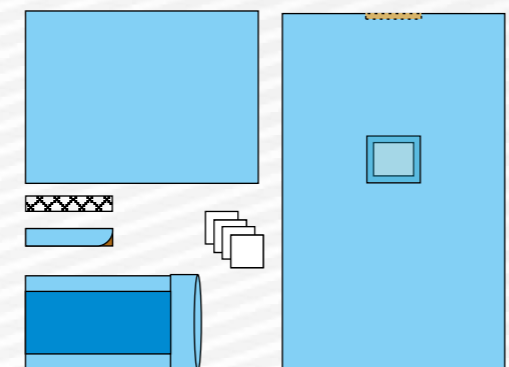

## BARRIER SYSTEM FOR SURGICAL THEATRES Sterile Surgical Drapes and Sets

## Orthopaedy

Limb drape with aperture in elastic membrane.

Code	301-151-S
Material	DS2
Size (cm)	70 x 75
Aperture (cm)	5
Accessories	Elastic membrane

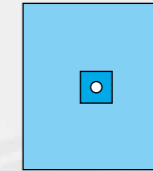

Limb drape, reinforced, with aperture in elastic membrane, short-term surgeries.

Code	302-109-S
Material	2SBL
Size (cm)	200 x 320
Reinforcement (cm)	DS2 75 x 90
Aperture (cm)	5
Accessories	Elastic membrane

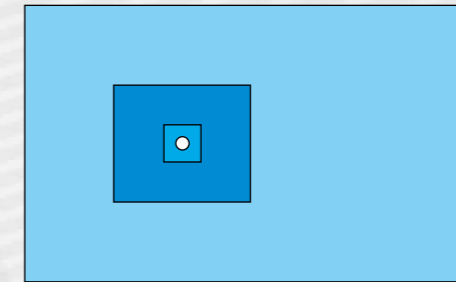

Limb drape, reinforced, with aperture in elastic membrane.

Code	301-155-S
Material	SMS
Size (cm)	240 x 320
Reinforcement (cm)	DS2 75 x 90
Aperture (cm)	5
Accessories	Elastic membrane

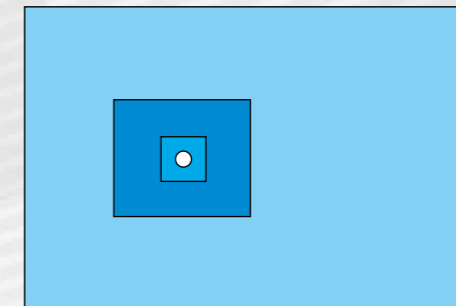

Knee drape, reinforced, with aperture in elastic membrane.

Code	301-104-S
Material	2SBL
Size (cm)	200 x 320
Reinforcement (cm)	DS2 100 x 150
Aperture (cm)	6 x 8
Accessories	Elastic membrane

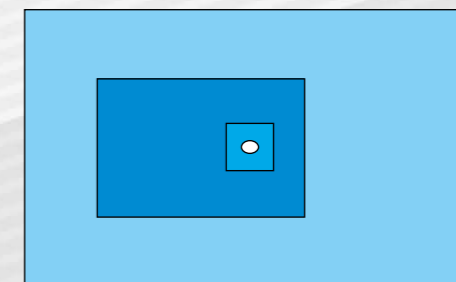

## Orthopaedy

Knee drape, reinforced, collection pouch with 2 perforated elastic membranes.

Code	301-803-S
Material	2SBL
Size (cm)	200 x 320
Reinforcement (cm)	DS2 34 x 57
Aperture (cm)	2x (6 x 8)
Accessories	2 elastic membranes, pouch

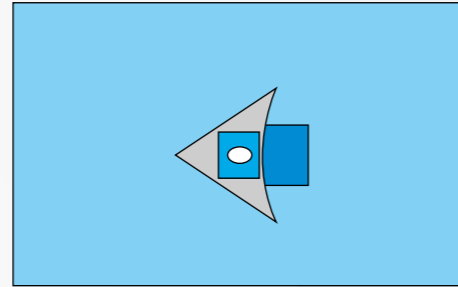

Vertical drape with adhesive edge, IF and collection pouch.

Code	301-509-S
Material	PE
Size (cm)	240 x 330
Aperture (cm)	25 x 86
Accessories	AT, IF, pouch

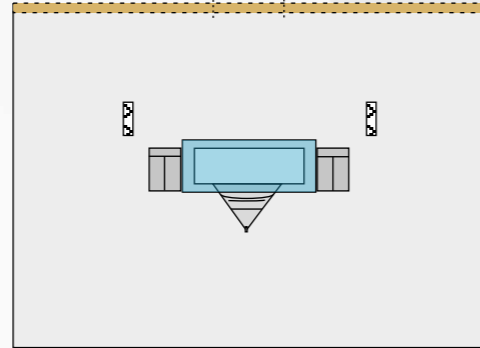

U-Drape with adhesive opening.

Code	Material	Size (cm)	Aperture (cm)	Accessories
<b>2ply</b>				
301-105-S	DS2	200 x 240	6 x 95	AT
301-634-S	2SBL	150 x 200	6 x 65	AT
301-642-S	FS2	200 x 240	6 x 95	AT
301-643-S	2SBL	200 x 240	6 x 95	AT
<b>3ply</b>				
301-159-S	DS3	240 x 280	10 x 115	AT
301-601-S	DS3	150 x 200	6 x 65	AT
301-602-S	DS3	200 x 240	6 x 95	AT

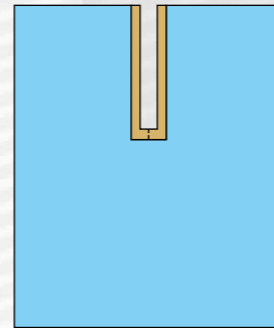

U-Drape, reinforced, with adhesive opening.

Code	Material	Size (cm)	Reinforcement (cm)	Aperture (cm)	Accessories
301-106-S	2SBL	200 x 240	DS2 75 x 150	6 x 95	AT
301-156-S	2SBL	200 x 260	DS2 75 x 150	6 x 115	AT
301-607-S	2SBL	240 x 280	DS2 100 x 150	10 x 115	AT
301-640-S	FS2	240 x 280	DS2 75 x 150	6 x 95	AT
301-644-S	DS3	200 x 320	DS2Lam 75 x 150	6 x 95	AT

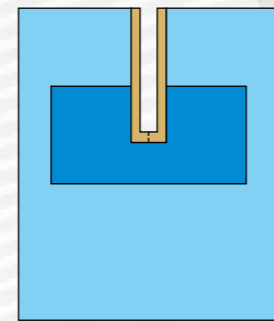

## BARRIER SYSTEM FOR SURGICAL THEATRES Sterile Surgical Drapes and Sets

## Orthopaedy

### Varix Surgery Set 303-112-S

Component	Material	Size (cm)	Pcs
Wrapping sheet	FS2	75 x 80	1
Instruments table drape	2SBL	100 x 150	1
U-drape, adhesive opening 10 x 115 cm	DS3	240 x 280	1
Surgical drape	SMS	50 x 50	1
MAYO cover	PE/DS2	80 x 145 / 50 x 145	1
Surgical gown Classic	SMMMS	L	1

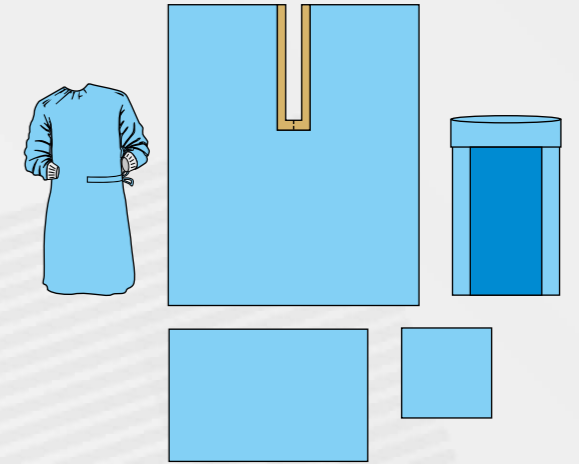

### Limb Surgery Set ECO 303-169-S

Component	Material	Size (cm)	Pcs
Wrapping sheet	FS2	75 x 80	1
Instruments table drape	FS2	150 x 180	1
U-drape, adhesive opening 6 x 95 cm	FS2	200 x 240	1
Surgical drape with adhesive edge	FS2	150 x 240	1
OP tape	AT+Vis	10 x 50	1
MAYO cover	PE/SB28	80 x 145 / 50 x 145	1
Absorbent towel	Airlaid cellulose	30 x 33	4

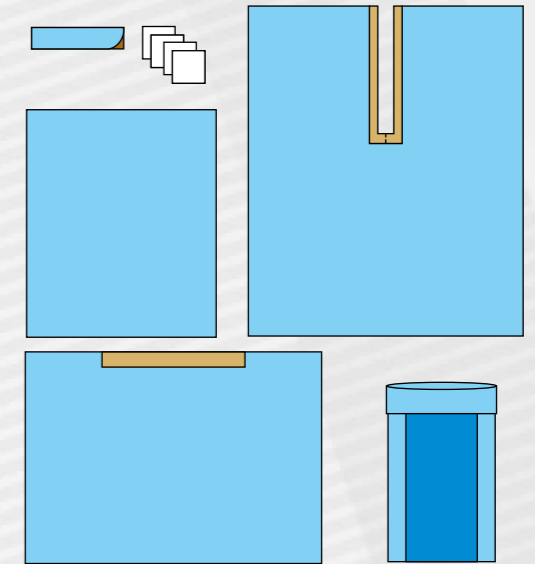

### Limb Surgery Set ECO 303-170-S

Component	Material	Size (cm)	Pcs
Instruments table drape	FS2	150 x 180	1
Limb drape reinforced, aperture in elast. membr.	FS2+DS2	240 x 320	1
OP tape	AT+Vis	10 x 50	1
MAYO cover	PE/SB28	80 x 145 / 50 x 145	1
Absorbent towel	Airlaid cellulose	30 x 33	1

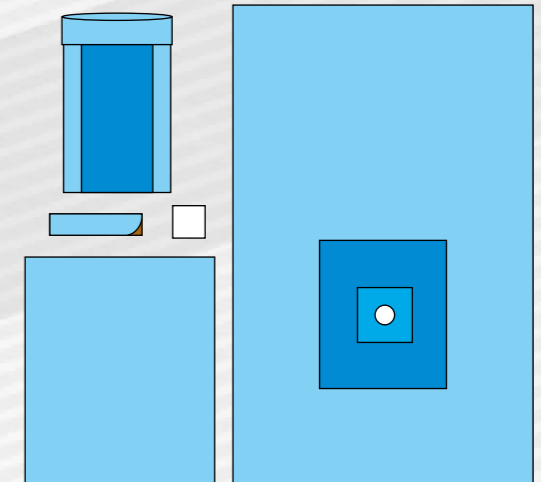



## Orthopaedy

### Limb Surgery Set ECO 303-151-S

Component	Material	Size (cm)	Pcs
Instruments table drape	2SBL	150 x 180	1
Limb drape reinforced, aperture in elast. membr.	SMS+DS2	240 x 320	1
OP tape	AT+Vis	10 x 50	1
MAYO cover	PE/SB28	80 x 145/50 x 145	1
Absorbent towel	Airlaid cellulose	30 x 33	1

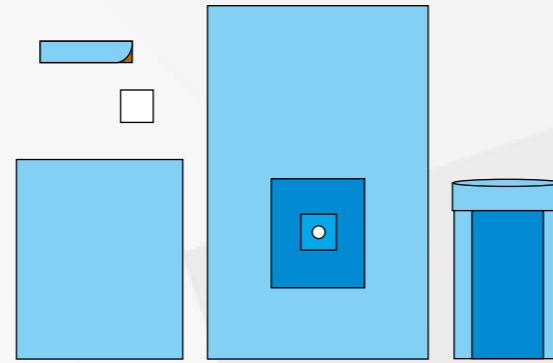

### Limb Surgery Set ECO 303-161-S

Component	Material	Size (cm)	Pcs
Wrapping sheet	FS2	75 x 80	1
Instruments table drape	2SBL	150 x 180	1
U-drape 2SBL, adhesive opening 6 x 95 cm	2SBL	200 x 240	1
Surgical drape with adhesive edge	2SBL	150 x 240	1
OP tape	AT+Vis	10 x 50	1
MAYO cover	PE/SB28	80 x 145/50 x 145	1
Absorbent towel	Airlaid cellulose	30 x 33	4

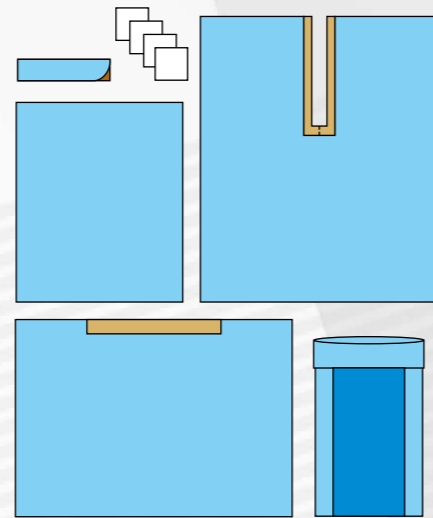

### Arthroscopy Knee Set 301-376-S

Component	Material	Size (cm)	Pcs
Wrapping sheet	FS2	75 x 80	1
MAYO cover	PE/DS2	80 x 145/50 x 145	1
Limb cover	DS2	30 x 80	1
OP tape	AT+Vis	10 x 50	1
Dinafix	Velcro	2,5 x 20	1
Camera cover	PE	14 x 250	1
Knee drape reinforced, aperture in elast. membr.	2SBL+DS2	200 x 320	1

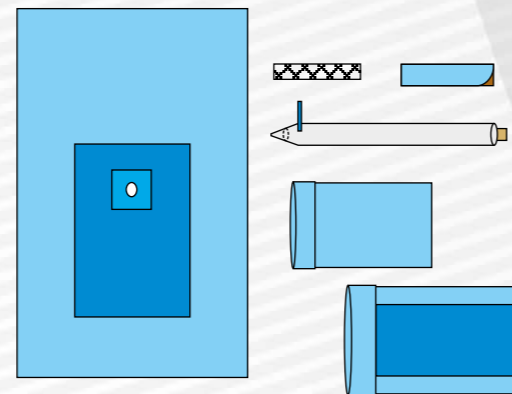

## BARRIER SYSTEM FOR SURGICAL THEATRES Sterile Surgical Drapes and Sets

## Orthopaedy

### Knee Set 301-101-S

Component	Material	Size (cm)	Pcs
Wrapping sheet	FS2	75 x 80	1
Instruments table drape	2SBL	150 x 200	1
Knee drape reinforced, aperture in elast. membr.	2SBL+DS2	200 x 320	1
Surgical drape	SMS	150 x 180	1
Limb cover	DS2	30 x 80	1
OP tape	AT+Vis	10 x 50	2
Towel	VIS40	20 x 30	4

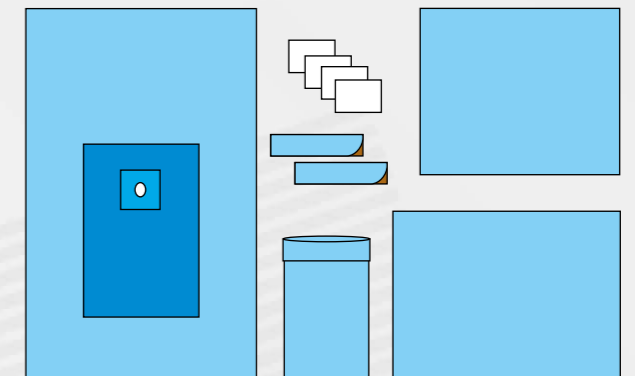

### Shoulder Set 302-183-S

Component	Material	Size (cm)	Pcs
Instruments table drape	FS2	150 x 190	1
Shoulder drape, aperture in elast. membr.	2SBL	240 x 360	1
OP tape	AT+Vis	10 x 50	2
Limb cover	2SBL	30 x 80	1
MAYO cover	PE/SB28	80 x 145/50 x 145	1

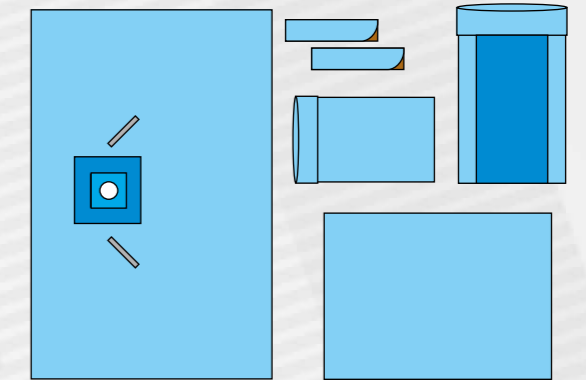

### Hip Set 301-450-S

Component	Material	Size (cm)	Pcs
Wrapping sheet	FS2	100 x 100	1
Instruments table drape	2SBL	150 x 200	1
Surgical drape	2SBL	150 x 200	1
Surgical drape with adhesive edge	DS2	150 x 240	1
U-drape reinforced, adhesive opening 6 x 95 cm	DS3 +DS2Lam	200 x 320	1
OP tape	AT+Vis	10 x 50	2
Limb cover	DS2	40 x 120	1
MAYO cover	PE/DS2	80 x 145/50 x 145	1

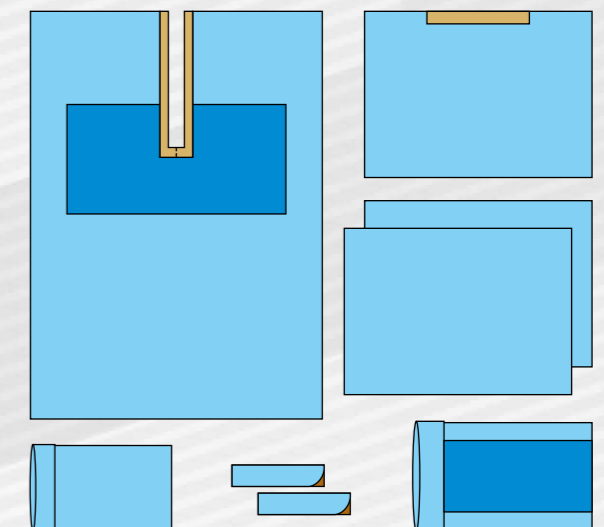

## Cardiovascular Surgery

Angio drapes are usually equipped with high absorbent reinforced area to retain leaking blood and with 2 or 4 apertures with IF or AT. Some drapes have PE transparent foil on one or both sides. Cardiovascular drapes can be equipped with tube holders, fixing tapes and collection pouches.

Angio drape with 2 PE transparent sides and 2 adhesive apertures.

Code	501-241-S
Material	DS2
Size (cm)	210 x 300
Aperture (cm)	2x (6 x 8)
Accessories	AT

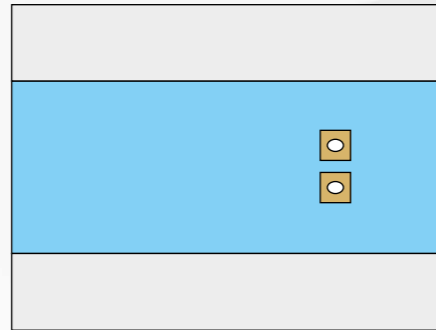

Angio drape, reinforced, with 2 PE transparent sides and 2 apertures in IF.

Code	501-239-S
Material	DS2
Size (cm)	220 x 365
Reinforcement (cm)	SM 65 x 77
Aperture (cm)	2x (12)
Accessories	IF with aperture 8 cm

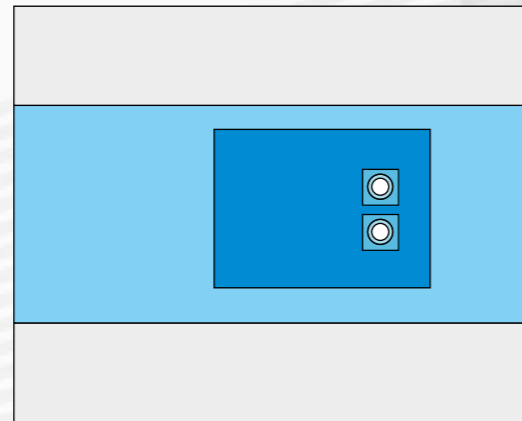

Angio drape, reinforced, with 2 PE transparent sides and 2 apertures with IF.

Code	501-240-S
Material	SMS
Size (cm)	220 x 330
Reinforcement (cm)	FSM80 75 x 120
Aperture (cm)	2x (12)
Accessories	IF

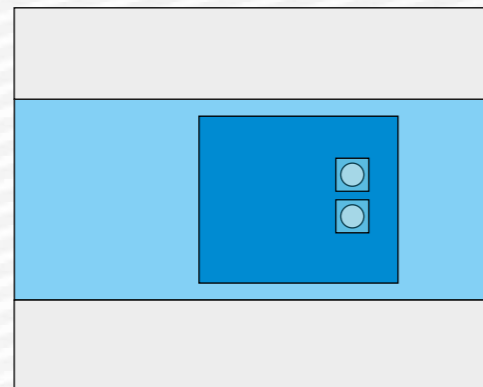

## BARRIER SYSTEM FOR SURGICAL THEATRES Sterile Surgical Drapes and Sets

## Cardiovascular Surgery

Angio drape, reinforced, with 2 PE transparent sides and 4 apertures in IF.

Code	501-242-S
Material	SMS+PE
Size (cm)	240 x 345
Reinforcement (cm)	FSM 122 x 130
Aperture (cm)	2x (14), 2x (9 x 12)
Accessories	IF with aperture 2x (11), 2x (7 x 9)

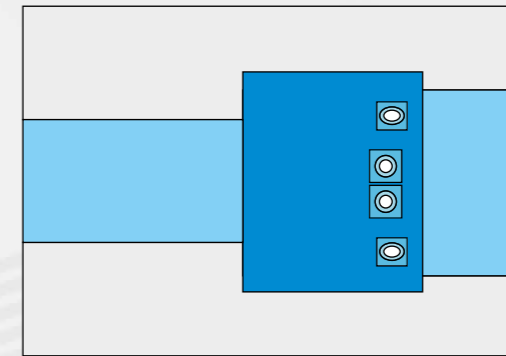

Cardiovascular drape with IF, 2 pouches and 3 tube holders.

Code	503-100-S
Material	DS3
Size (cm)	280 x 340
Aperture (cm)	32 x 40
Accessories	IF, holders, 2 pouches DS2

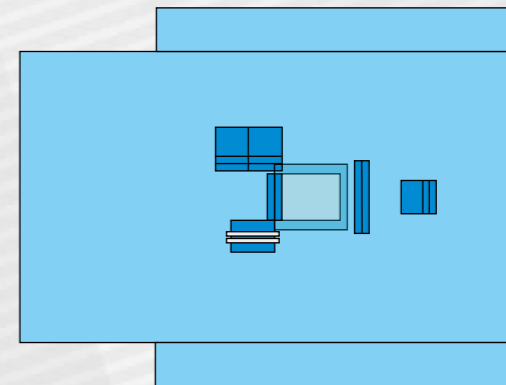

Pectoral drape, reinforced, with IF, a holder and 2 pouches.

Code	503-113-S
Material	SMS
Size (cm)	260 x 360
Reinforcement (cm)	FSM80 100 x 200
Aperture (cm)	32 x 40
Accessories	IF, holder, 2 pouches FSM80

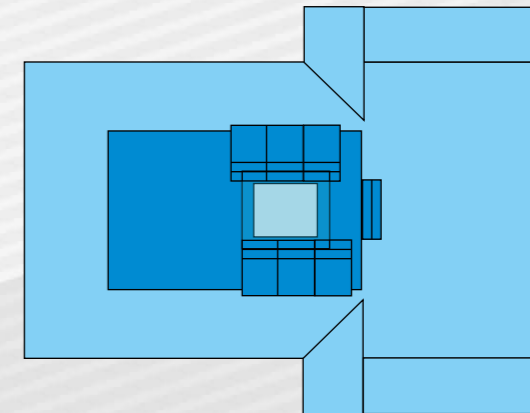

# Cardiovascular Surgery

## Angio Set 501-100-S

Component	Material	Size (cm)	Pcs
Wrapping sheet	FS2	75 x 80	1
Instruments table drape, AT in the middle	2SBL	100 x 180	1
Surgical drape	SMS	70 x 160	1
OP tape	AT+SMS	15 x 20	1
Angiography drape, 2x adhesive aperture	DS2	210 x 300	1
Surgical gown Classic	SMMMS	XL	1

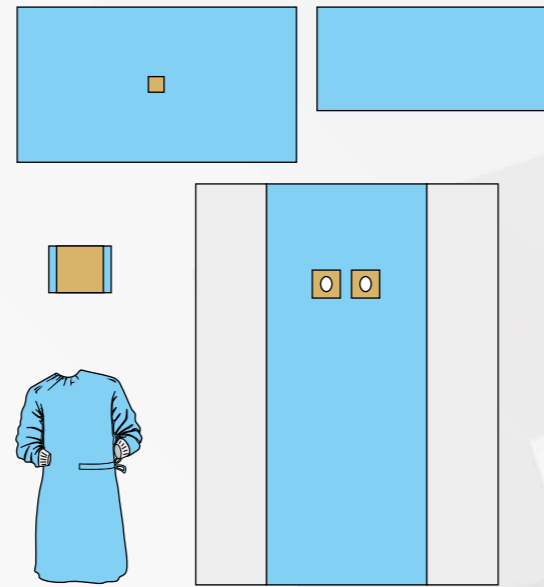

## CV Set VALVES 503-001-S

Component	Material	Size (cm)	Pcs
Instruments table drape	FS2	140 x 150	1
Instruments table drape reinforced	2SBL+DS3	150 x 200	1
Surgical gown Classic	SMMMS	XXL	2
Surgical gown Classic reinforced	SMMMS	XXL	2
Cardiovascular drape with IF and 2 pouches	DS3	280 x 340	1
Drape with adhesive edge	2SBL	75 x 90	2
OP tape	AT+Vis	10 x 50	1
Drape-white	SB40	50 x 60	2
Surgical drape	2SBL	100 x 150	1
MAYO cover	PE/DS2	80 x 145 / 50 x 145	1
Collection pouch	2SBL	30 x 55	3

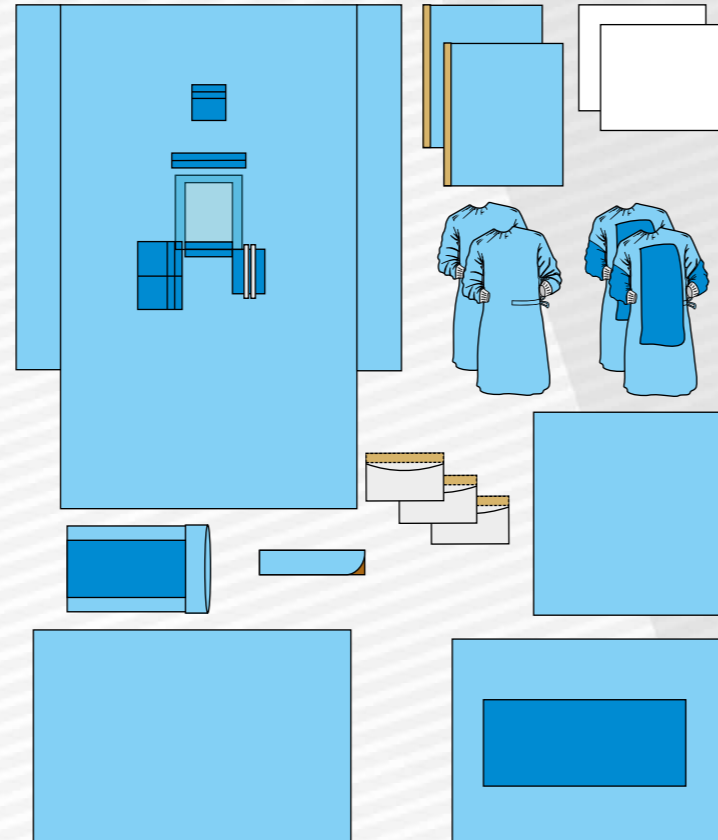

# BARRIER SYSTEM FOR SURGICAL THEATRES Sterile Surgical Drapes and Sets

# Cardiovascular Surgery

## CV Set BYPASS 503-002-S

Component	Material	Size (cm)	Pcs
Instruments table drape	FS2	140 x 150	1
Instruments table drape reinforced	2SBL+DS3	150 x 200	1
Surgical gown Classic	SMMMS	XXL	2
Surgical gown Classic reinforced	SMMMS	XXL	2
Cardiovascular drape with IF and 2 pouches	DS3	280 x 340	1
U-drape with perineum cover, adhesive opening	2SBL+DS3	200 x 240	1
Drape with adhesive edge	2SBL	75 x 90	2
Foot cover	DS2	Uni	2
Drape-white	SB40	30 x 40	3
Drape-white	SB40	50 x 60	2
Surgical drape	2SBL	100 x 150	1
Surgical drape	2SBL	150 x 175	1
OP tape	AT+Vis	10 x 50	1
MAYO cover	PE/DS2	80 x 145 / 50 x 145	1
Collection pouch	2SBL	30 x 55	3

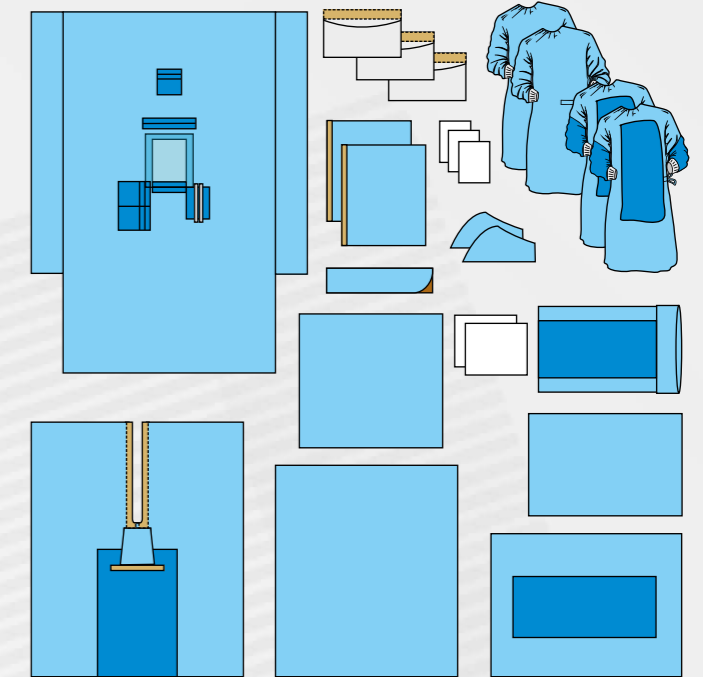

## Pectoral Surgery Set 503-063-S

Component	Material	Size (cm)	Pcs
Wrapping sheet	FS2	100 x 100	1
Instruments table drape	2SBL	150 x 200	1
Pectoral drape reinforced with IF and 2 pouches	SMS+DS2	260 x 360	1
Surgical drape	SMS	90 x 90	2
Surgical drape with adhesive edge	SMS	90 x 90	2
MAYO cover, telescopic folding	PE/DS2+3SBL	80 x 145 / 73 x 80	1

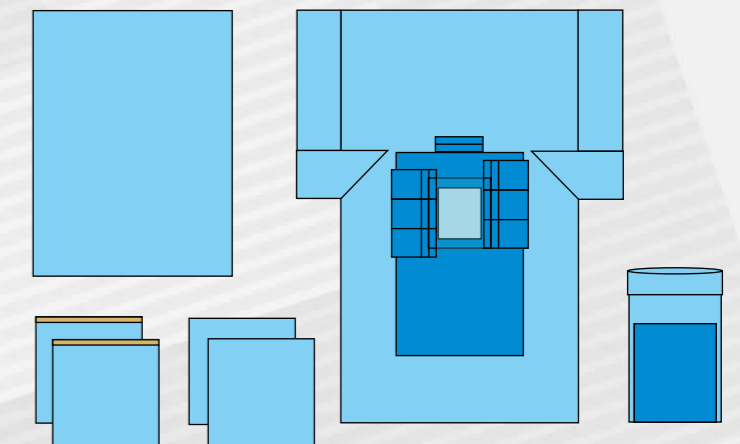

## Urology

Combined TUR drape, adhesive aperture with collection pouch.

Code	603-205-S
Material	DS3+PE
Size (cm)	220 x 300
Aperture (cm)	6 x 10
Accessories (cm)	AT, pouch

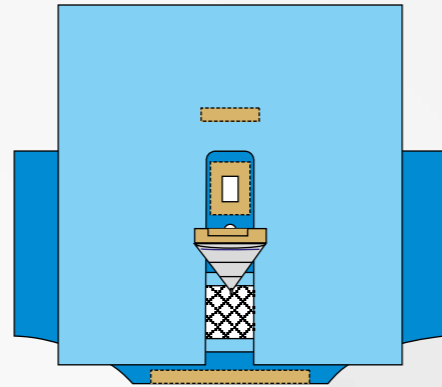

Combined TUR drape with aperture.

Code	603-126-S
Material	SMS+DS2
Size (cm)	(150 x 160) + (50 x 110)
Aperture (cm)	5,5 x 12,5

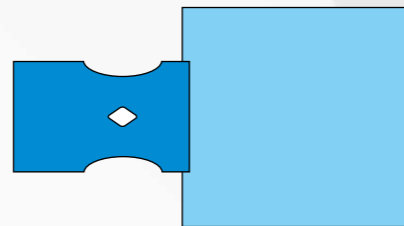

Urology drape reinforced, with 2 apertures and collection pouch.

Code	603-209-S
Material	SMS
Size (cm)	200 x 260
Reinforcement (cm)	DS2 30 x 70
Aperture (cm)	5 and 6 x 8
Accessories (cm)	Pouch

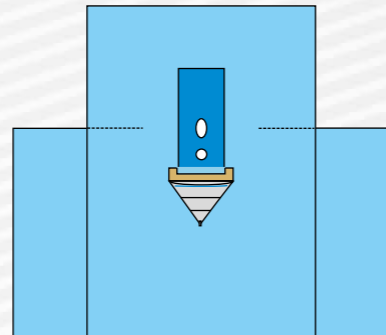

Surgical drape with adhesive edge and adhesive aperture.

Code	604-108-S
Material	2SBL
Size (cm)	180 x 200
Reinforcement (cm)	Vis 75 x 100
Aperture (cm)	20 x 2 x (22,5)
Accessories (cm)	AT

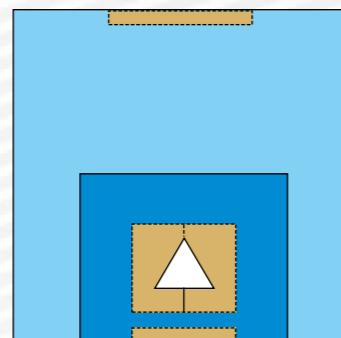

## BARRIER SYSTEM FOR SURGICAL THEATRES Sterile Surgical Drapes and Sets

## Urology

### TUR Set 603-166-S

Component	Material	Size (cm)	Pcs
Wrapping sheet	FS2	75 x 80	1
Instruments table drape	2SBL	100 x 150	1
TUR drape combined	SMS+DS2	150 x 225	1
Limb cover	SMS	80 x 100	2
Surgical gown Prima reinforced	SMS	XXL	1
Surgical gown Prima	SMS	L	1

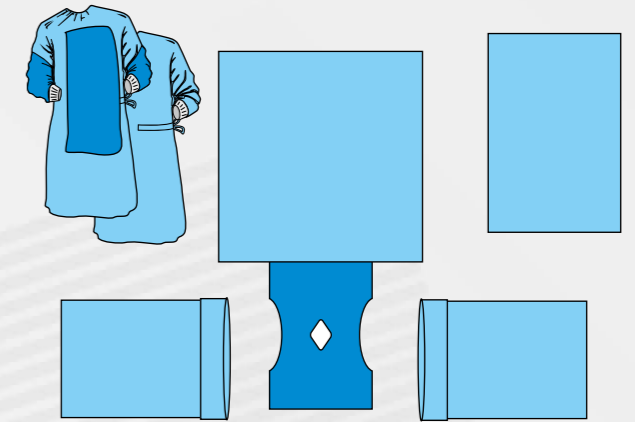

### Rectum surgery Set 604-003-S

Component	Material	Size (cm)	Pcs
Wrapping sheet	FS2	75 x 80	1
Instruments table drape	2SBL	100 x 150	1
MAYO cover	PE/DS2	80 x 145 / 50 x 145	1
Limb cover	SMS	80 x 100	2
TUR drape combined	SMS+DS2	150 x 265	1

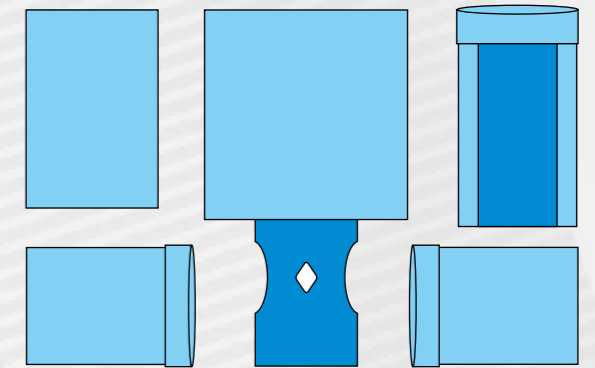

### TUR Set 603-213-S

Component	Material	Size (cm)	Pcs
Instruments table drape	2SBL	150 x 180	1
TUR drape, 2 apertures in elast.membr, pouch and leggins	DS2	180 x 260	1

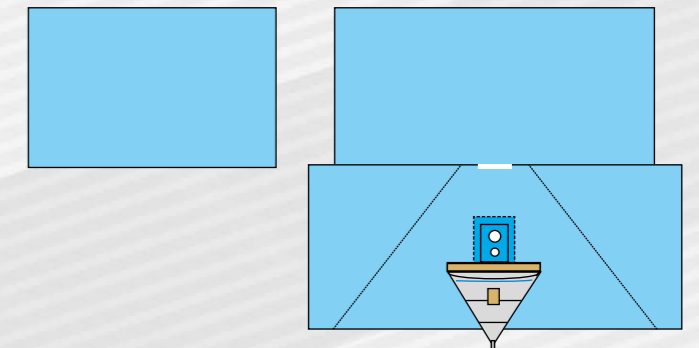

## Gynaecology

Perineum drape with adhesive edge and adhesive aperture.

Code	604-105-S
Material	DS2
Size (cm)	75 x 120
Aperture (cm)	10 x 20
Accessories (cm)	AT

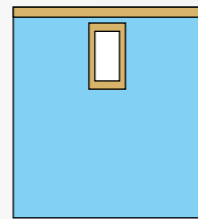

Vaginal drape, reinforced, with AT and aperture in elastic membrane.

Code	603-202-S
Material	SMS
Size (cm)	200 x 260
Reinforcement (cm)	DS2
Aperture (cm)	6 x 15
Accessories (cm)	AT, elastic membrane

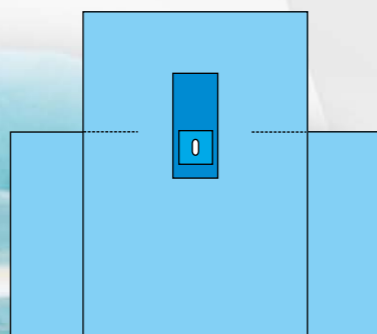

Caesarean drape, reinforced, with IF and PUR foam brace pouch.

Code	602-210-S
Material	DS3
Size (cm)	250 x 340
Reinforcement (cm)	DS2Lam 80 x 100
Aperture (cm)	34 x 34
Accessories (cm)	Dinafix, IF, pouch

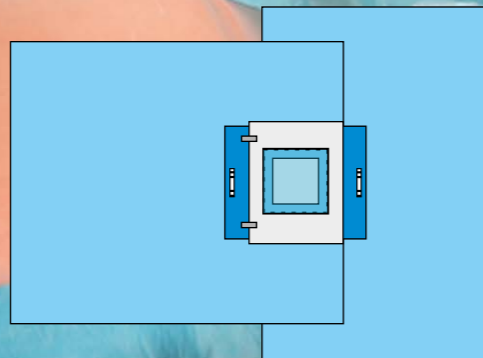

Caesarean drape with adhesive aperture and PUR foam brace pouch.

Code	602-207-S
Material	DS2
Size (cm)	200 x 320
Aperture (cm)	25 x 30
Accessories (cm)	AT, pouch

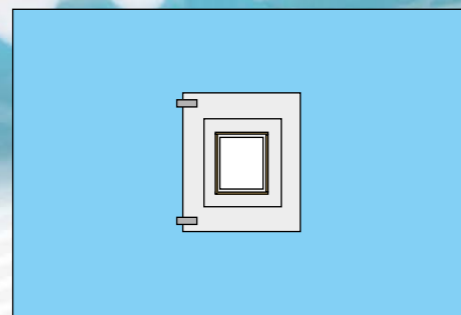

## BARRIER SYSTEM FOR SURGICAL THEATRES Sterile Surgical Drapes and Sets

## Gynaecology

### Gynaecology Set 601-103-S

Component	Material	Size (cm)	Pcs
Wrapping sheet	FS2	75 x 80	1
Instruments table drape	2SBL	100 x 150	1
Reinforced drape with adhesive edge	2SBL+Vis28	180 x 200	1
Perineum drape, adhesive aperture	DS2	75 x 120	1
Limb cover	SMS	80 x 120	2
Surgical drape	2SBL	100 x 150	1
Surgical drape	SMS	50 x 50	1
OP tape	AT+Vis28	10 x 50	2
MAYO cover	PE/SB28	80 x 145/50 x 145	1
Surgical gown Classic	SMMMS	size L	1
Absorbent towel	Airlaid cellulose	30 x 33	4

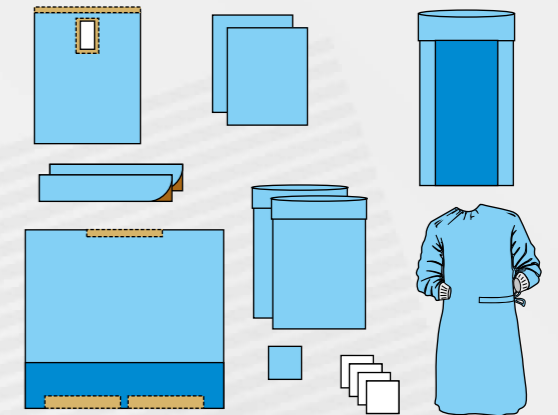

### Gyn Set for Laparoscopy 601-132-S

Component	Material	Size (cm)	Pcs
Wrapping sheet	FS2	75 x 80	1
Instruments table drape	2SBL	150 x 200	1
Absorbent towel	Airlaid cellulose	30 x 33	2
Surgical drape	DS2	75 x 90	1
Limb cover	SMS	80 x 120	2
Surgical drape with adhesive aperture and edge	2SBL+Vis28	180 x 200	1
MAYO cover	PE/SB28	80 x 145/50 x 145	1

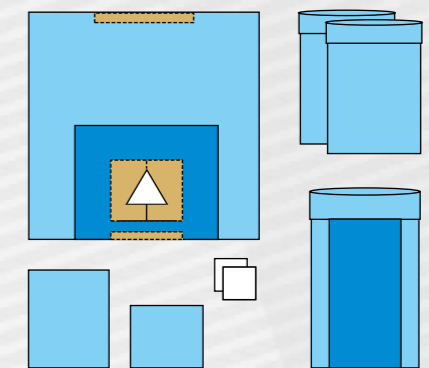

### LAVH Set 601-107-S

Component	Material	Size (cm)	Pcs
Wrapping sheet	FS2	100 x 100	1
Instruments table drape	2SBL	100 x 150	1
Perineum drape, adhesive aperture, pouch	DS2	75 x 120	1
Limb cover	SMS	80 x 140	2
Laparotomy drape reinforced, IF	2SBL+Vis28	180 x 200	1
Surgical drape	SMS	75 x 120	3
MAYO cover	PE/SB28	80 x 145/50 x 145	2
Surgical drape	2SBL	100 x 150	1
Camera cover	PE	14 x 250	1
Syringe LS	PP	10ml	1
Scalpel blade type 20			1
Scalpel blade type 11			1
Tampon twisted, RTG	Gauze	30 x 30	40
Tampon twisted, RTG	Gauze	20 x 20	20
Gauze compress	Gauze	10 x 20	4
Folded gauze	Gauze	15 x 30	4
Surgical gown Classic	SMMMS	XL	3
Surgical gown Classic	SMMMS	L	1

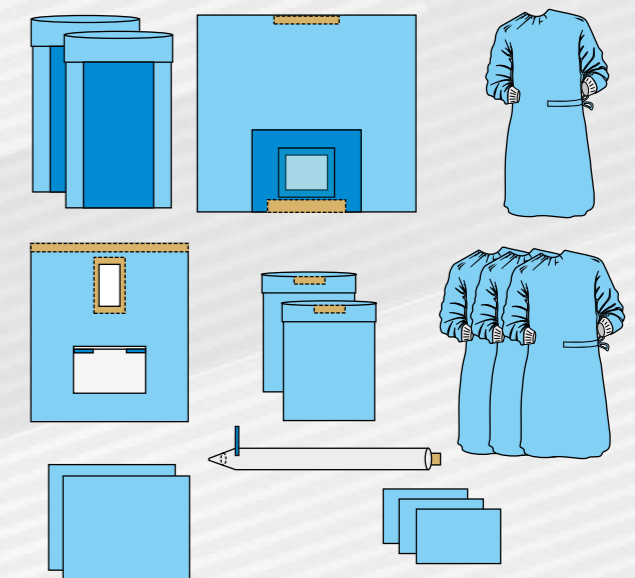

## Gynaecology

### Caesarean Set 602-153-S

Component	Material	Size (cm)	Pcs
Wrapping sheet	FS2	100 x 100	1
Instruments table drape	2SBL	100 x 150	1
Anaesthetic drape	SMS	100 x 155	1
Caesarean drape with PUR brace pouch and IF	DS2	200 x 210	1
OP tape	AT+Vis28	10 x 50	1
MAYO cover	PE/SB28	80 x 145 / 50 x 145	2
Surgical gown Classic reinforced	SMMMS	XL	1
Surgical gown Classic	SMMMS	XL	2
Surgical gown Classic	SMMMS	M	1

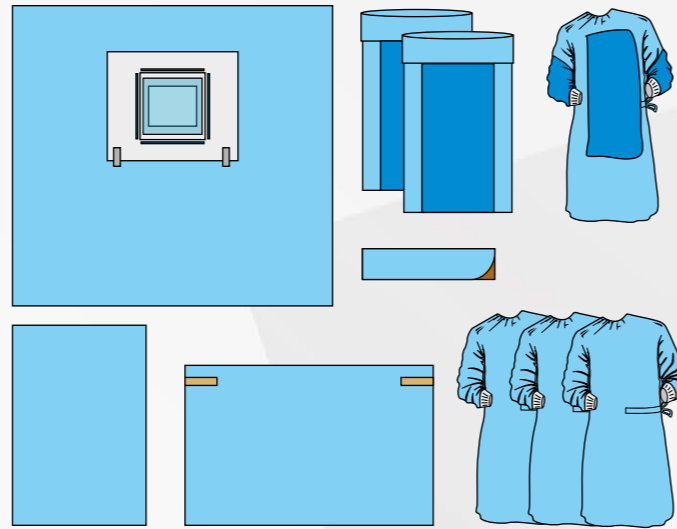

### Caesarean Set 602-121-S

Component	Material	Size (cm)	Pcs
Wrapping sheet	FS2	75 x 90	1
Caesarean drape with IF	DS2	240 x 320	1
MAYO cover	PE/SB28	80 x 145 / 50 x 145	1

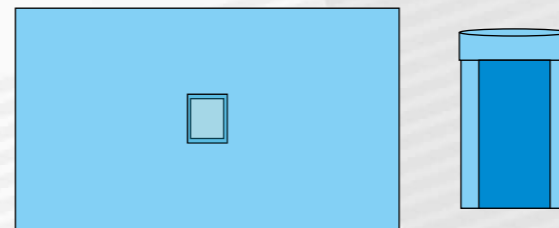

### Caesarean Set 602-147-S

Component	Material	Size (cm)	Pcs
Instruments table drape	FS2	150 x 190	1
Caesarean T-shape drape, PUR brace pouch and IF	2SBL	180 x 320	1
Absorbent pad Santex	Cellulose	60 x 90	1
Absorbent towel	Airlaid cellulose	30 x 33	2
MAYO cover	PE/SB28	80 x 145 / 50 x 145	1

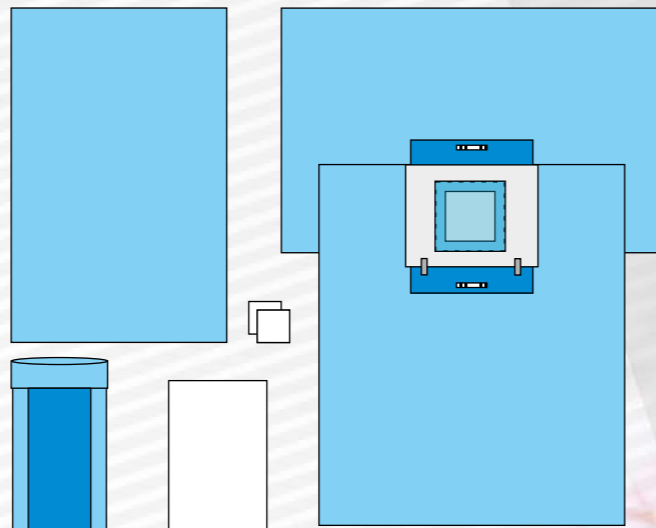

## BARRIER SYSTEM FOR SURGICAL THEATRES Sterile Surgical Drapes and Sets

## Delivery and Newborn Sets

Sets are applied on women during labour, suitable for newborns as well. Using disposable products reduces risk of infection.

Common items used in these sets:

Bed sheet	SB, 2SBL
Drapes	variety of types and materials
Impervious protective apron	PE
Impervious sleeve cover	PE
Isothermic foil	
Limb covers	SMS
Table cover	FS2, 2SBL
Protective gown	SB
Surgical gown PRIMA	SMS
Instruments:	Scalpel, scissors sharp, umbilical clamp
Umbilical tie	Plastics
Abdominal sponge	Gauze, NW
Absorbent pad	ONTEX
Absorbent towel	Vis, tissue
Compress	Gauze, NW
Cotton sheet	
Sanitary towel	
Twisted tampon	Gauze
Gloves	Latex

## Delivery and New-born Sets

### Delivery Set 60550-44-S

Component	Material	Size (cm)	Pcs
Wrapping sheet	FS2	75 x 80	1
Instruments table drape	2SBL	80 x 100	1
Absorbent towel	VIS40	20 x 30	6
Umbilical tie		1 x 15	1
Umbilical clamp			2
Absorbent towel	Spunlace	70 x 80	1
Absorbent pad Santex	Cellulose	60 x 90	1
PE-Apron, white	PE	80 x 125	1
Surgical drape	2SBL	75 x 130	1

### Delivery Set 60550-52-S

Component	Material	Size (cm)	Pcs
Instruments table drape	2SBL	80 x 100	1
Surgical drape	2SBL	75 x 130	1
Surgical gloves, powdered, 1 pair	Latex	Size 8	2
PE-Apron, white	PE	80 x 125	2
Scalpel type 11			1
Absorbent towel	VIS40	20 x 30	2
Umbilical tie		1 x 15	3
Umbilical clamp			2
Sanitary towel			2
Wrapping sheet	FS2	60 x 60	1
Surgical drape	2SBL	60 x 60	1
Isothermic foil		70 x 90	1
Cotton sheet		70 x 70	2
Suction catheter, 6ch			1

### Delivery Set 60550-57-S

Component	Material	Size (cm)	Pcs
Wrapping sheet	FS2	75 x 80	1
Absorbent pad Santex	Cellulose	60 x 90	1
Umbilical clamp			2
Scissors-sharp	Stainless	11,5	1
Examination gloves, powdered	Latex	M	2
Examination gloves, powdered	Latex	L	2
Umbilical tie		1 x 15	2
Abdominal drape	NW	60 x 60	1
Gauze compress	Gauze	10 x 10	10
Tampon twisted	Gauze	30 x 30	10

## BARRIER SYSTEM FOR SURGICAL THEATRES Sterile Surgical Drapes and Sets

## Ophthalmology

Ophthalmic drape with IF and 2 collection pouches.

Code	201-101-S
Material	SMS
Size (cm)	120 x 160
Aperture (cm)	11 x 12
Accessories	IF, 2 pouches

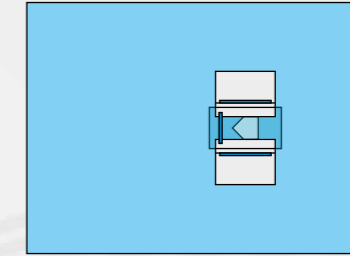

Ophthalmic drape with IF and 1 collection pouch.

Code	201-209-S
Material	SMS
Size (cm)	120 x 135
Aperture (cm)	7
Accessories	IF, 1 pouch

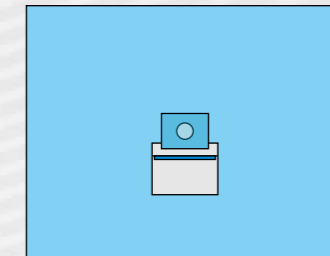

Ophthalmic drape with IF.

Code	201-210-S
Material	SMS
Size (cm)	100 x 100
Aperture (cm)	6 x 8
Accessories	IF

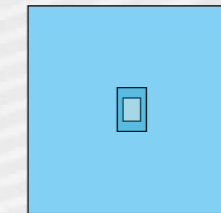

Ophthalmic drape LASIC with IF.

Code	201-201-S
Material	DS2
Size (cm)	34 x 34
Aperture (cm)	11 x 12
Accessories	IF

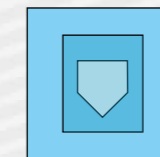

Ophthalmic drape with perforated IF.

Code	201-292-S
Material	SMS
Size (cm)	100 x 100
Aperture (cm)	7 x 10
Accessories	Perforated IF

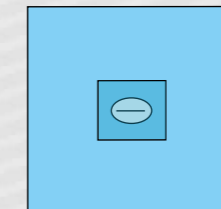

# Ophthalmology

## Eyelid Pack 40-14-028-S

Component	Material	Size (cm)	Pcs
Instruments table drape	2SBL	100 x 150	1
Ophthalmic drape with adhesive aperture, 2 pouches	SMS	95 x 100	1
Transparent bowl	PE	250 ml	1
Twisted tampon	Gauze	30 x 30	4
Hypodermic needle grey		0,4 x 40, 27G x 1 1/2"	2
Hypodermic needle pink		1,2 x 40, 18G x 1 1/2"	1
Non-woven compress, 4ply	NW	7,5 x 7,5	10
Syringe LL	PP	2 ml	2

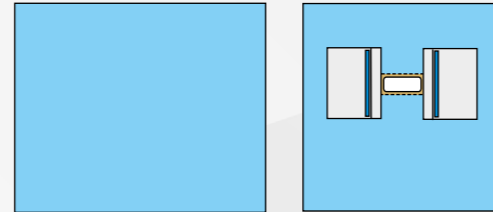

# BARRIER SYSTEM FOR SURGICAL THEATRES Sterile Surgical Drapes and Sets

# Ophthalmology

## Set PHACO 201-083-S

Component	Material	Size (cm)	Pcs
Wrapping sheet	FS2	75 x 80	1
Ophthalmic drape with IF, 2 pouches	SMS	120 x 160	1
Surgical drape with adhesive edge	SMS	52 x 80	1
Handle cover	SMS	20 x 50	2
Device cover PHACO	SMS	42 x 57	1
Instruments table cover, reinforced	SMS, SBPE	50 x 77,5	1

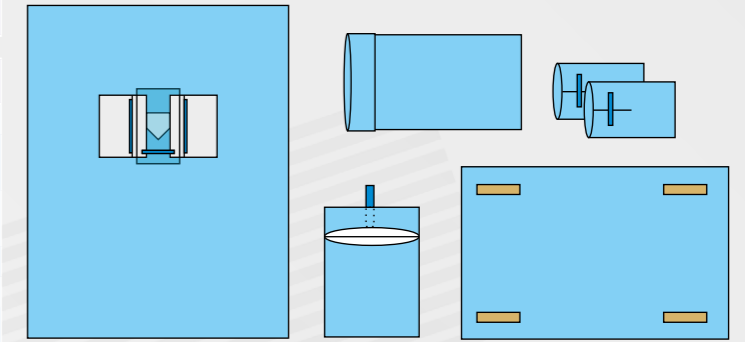

## Cataract Set 201-132-S

Component	Material	Size (cm)	Pcs
Wrapping sheet	DS2	50 x 70	1
Handle cover	SMS	20 x 75	2
IF	PU	15 x 20	1
Surgical drape with adhesive aperture	DS2	150 x 180	1
Examination gloves	Latex	size 7-8	1
MAYO cover	PE/SB28	80 x 145/50 x 145	1
Drying tampon	NW+ cellulose	0,5 x 6,5	5
Hypodermic needle brown		26G x 1/2", 0,45 x 12 mm	1
Syringe LL	PP	10 ml	1
Syringe LL	PP	5 ml	1
Syringe LS	PP	2 ml	1
Insulin syringe U-100, with needle	PP	1 ml / 30G	1
Twisted tampon	Gauze	30 x 30	2

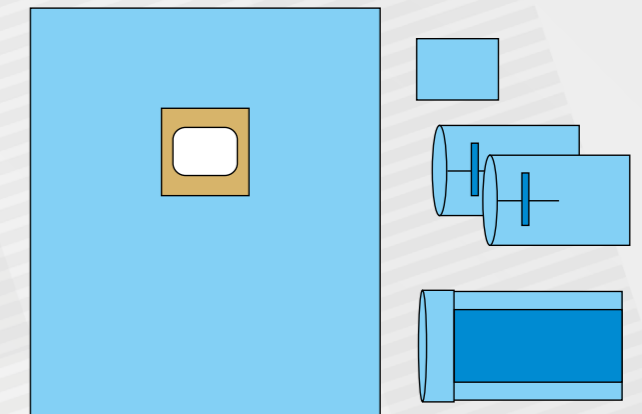

## Ophthalmic Set 60-04-034-S

Component	Material	Size (cm)	Pcs
Instruments table drape	FS2	60 x 60	1
Ophthalmic drape with perforated IF	SMS	50 x 60	1
Non-woven compress, 4ply	NW	10 x 10	5
Gallipot bowl	PP	60 ml	2
Cotton swab, small bud		15	2
Double ended scleral marker, flat	PP	0,35 - 0,40	1
Eye speculum (solid blades)	Stainless steel		1
Kocher	Stainless steel	13	1

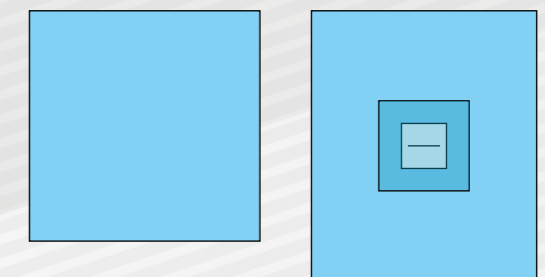



## Dentistry

Dental drape with aperture.

Code	801-103-S
Material	DS3
Size (cm)	150 x 150
Aperture (cm)	10 x 14

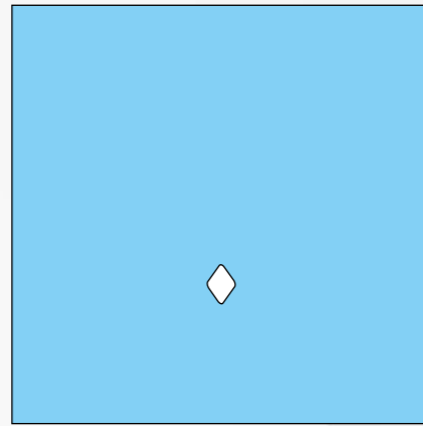

Dental drape with adhesive aperture.

Code	801-111-S
Material	SMS
Size (cm)	120 x 265
Aperture (cm)	10 x 14
Accessories	AT

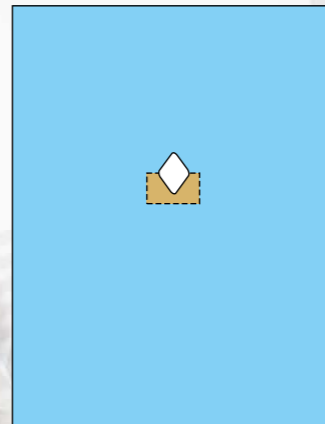

## BARRIER SYSTEM FOR SURGICAL THEATRES Sterile Surgical Drapes and Sets

## Dentistry

### Dental Set 801-001-S

Component	Material	Size (cm)	Pcs
Wrapping sheet	FS2	60 x 60	1
Instruments table drape	2SBL	75 x 90	1
Dental drape with aperture	DS3	150 x 150	1
Surgical drape	DS3	45 x 75	2
OP tape	AT+Vis	10 x 50	2
Cord cover	PE	8 x 120	2

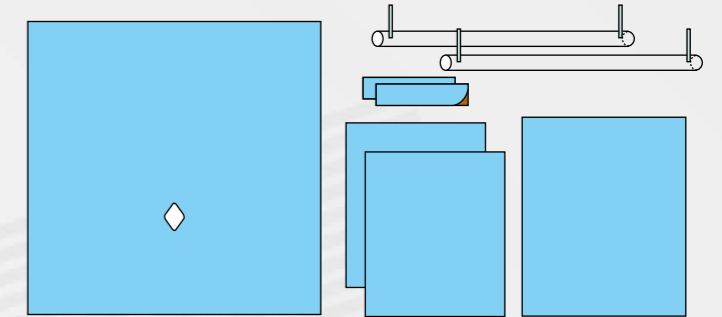

### Surgery Set - Implantology 801-013-S

Component	Material	Size (cm)	Pcs
Wrapping sheet	FS2	75 x 80	1
Instruments table drape	2SBL	80 x 120	1
OP tape	AT+Vis	5 x 20	2
Surgical drape	SMS	75 x 90	1
Dental drape with adhesive aperture	SMS	120 x 265	1
MAYO cover	PE/DS2	80 x 145 / 50 x 145	1
Absorbent towel	Airlaid cellulose	30 x 33	2
Flat bowl	PP	125 ml	1
Non-woven compress, 4ply	NW	5 x 5	3
Twisted tampon	Gauze	15 x 15	3
Surgical gown Prima	SMS	L	2

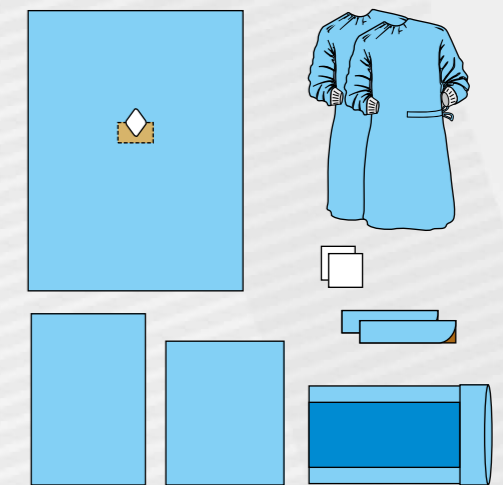

### Dental Set 60-19-126-S

Component	Material	Size (cm)	Pcs
Wrapping sheet	FS2	100 x 100	1
Dental drape	DS3	150 x 200	1
Tray 4 compartment	PP	15 x 22	1
Yankauer suction handle	PP		1
Gauze compress	Gauze	10 x 10	10
Cord cover	PE	8 x 120	2
Light handle cover with adhesive edge	SMS	15 x 20	4
Surgical drape with adhesive edge	DS2	75 x 75	3
Absorbent towel	Airlaid cellulose	30 x 33	2
Wrapping sheet	FS2	75 x 80	1
Surgical gown Prima	SMS	L	2
Cap Baret Standard	SB		2
Cap Forest Standard	SB		1

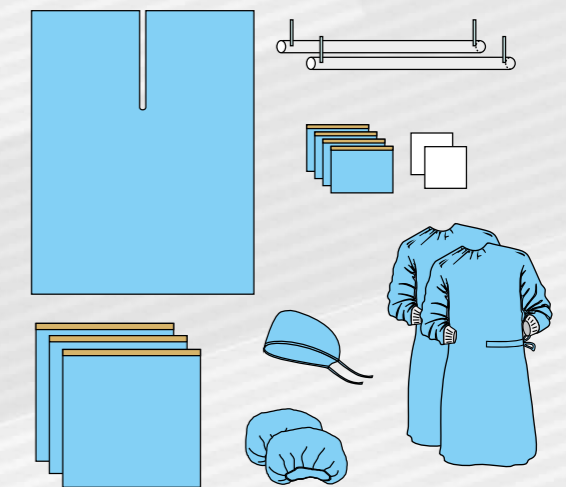

ORL drape-universal, reinforced, with adhesive aperture.

Code	106-102-S
Material	2SBL
Size (cm)	200 x 240
Reinforcement (cm)	Vis28 60 x 75
Aperture (cm)	7
Accessories	AT

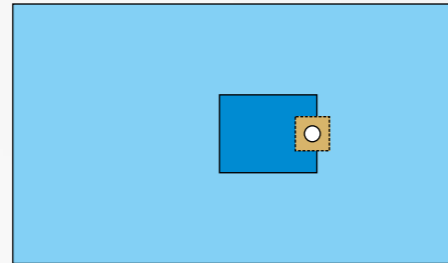

ORL drape, with adhesive aperture.

Code	106-103-S
Material	DS2
Size (cm)	200 x 240
Reinforcement (cm)	-
Aperture (cm)	7
Accessories	AT

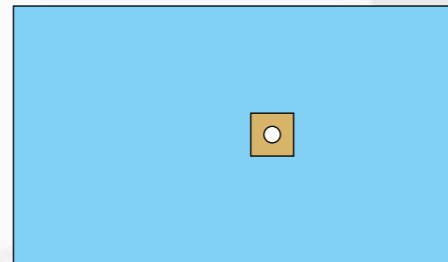

Tracheotomy drape reinforced, with adhesive aperture.

Code	501-008-S
Material	SMS
Size (cm)	160 x 300
Reinforcement (cm)	DS2 75 x 100
Aperture (cm)	10
Accessories	AT

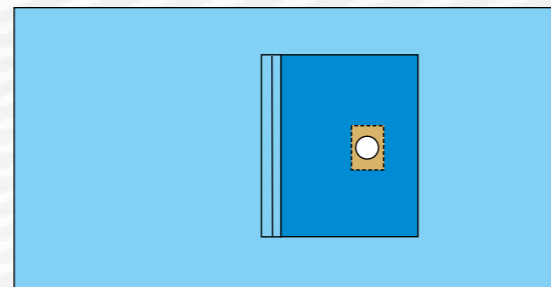

**BARRIER SYSTEM FOR SURGICAL THEATRES**  
Sterile Surgical Drapes and Sets

**ORL Set 106-056-S**

Component	Material	Size (cm)	Pcs
Instruments table drape	FS2	150 x 160	1
Surgical drape with adhesive aperture	FS2	170 x 240	1
Absorbent towel	Airlaid cellulose	30 x 33	1

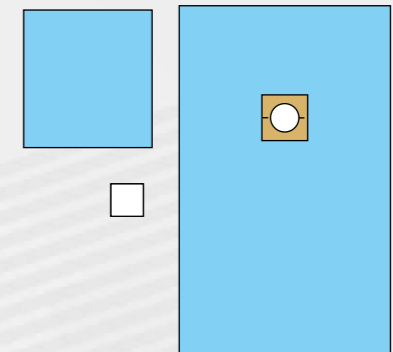

**Head and Neck Surgery Set 106-064-S**

Component	Material	Size (cm)	Pcs
Instruments table drape	FS2	150 x 190	1
U-drape, adhesive opening 6 x 40 cm	FS3	150 x 125	1
Surgical drape with adhesive edge	FS3	200 x 200	1
Absorbent towel	Airlaid cellulose	30 x 33	4
MAYO cover	PE/SB28	80 x 145 / 50 x 145	1

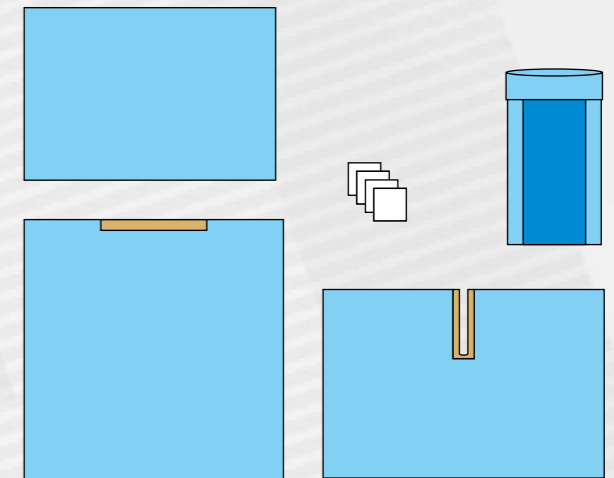

## Neurosurgery

Head drape with IF and a collection pouch.

Code	401-201-S
Material	DS3
Size (cm)	220 x 240
Aperture (cm)	10 x 20
Accessories	IF, pouch

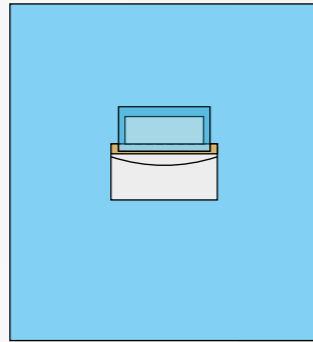

Spine drape, T-shape, with adhesive aperture and Dinafix tape.

Code	401-204-S
Material	DS3
Size (cm)	255 x 317
Aperture (cm)	6 x 20
Accessories	AT, Dinafix

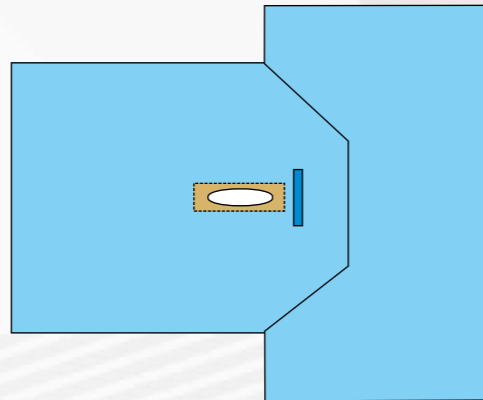

Spine drape with IF.

Code	401-202-S
Material	DS3
Size (cm)	150 x 280
Aperture (cm)	6 x 10
Accessories	IF

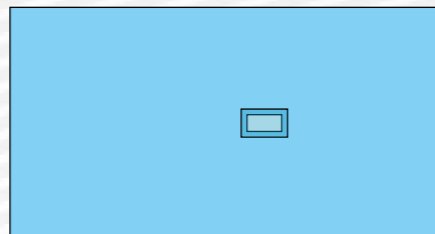

## BARRIER SYSTEM FOR SURGICAL THEATRES Sterile Surgical Drapes and Sets

## Neurosurgery

### Head Surgery Set 402-106-S

Component	Material	Size (cm)	Pcs
Wrapping sheet	FS2	75 x 80	1
Instruments table drape	2SBL	150 x 200	1
Dinafix	Velcro	2,5 x 20	1
OP tape	AT+Vis	10 x 50	1
Head drape with IF and a collection pouch	DS3	220 x 240	1
Absorbent towel	Airlaid cellulose	30 x 33	4
MAYO cover	PE/DS2	80 x 145/50 x 145	1

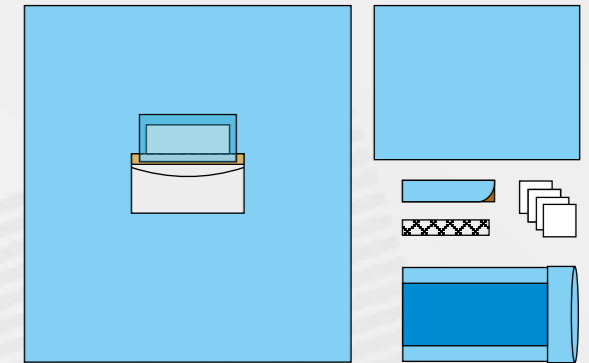

### Spine Surgery Set 401-116-S

Component	Material	Size (cm)	Pcs
Wrapping sheet	FS2	75 x 80	1
Instruments table drape	2SBL	150 x 200	1
Dinafix	Velcro	2,5 x 20	1
OP tape	AT+Vis	10 x 50	1
Collection pouch	PE	28 x 44	1
Spine drape with IF	DS3	150 x 280	1
Absorbent towel	Airlaid cellulose	30 x 33	4
MAYO cover	PE/DS2	80 x 145/50 x 145	1

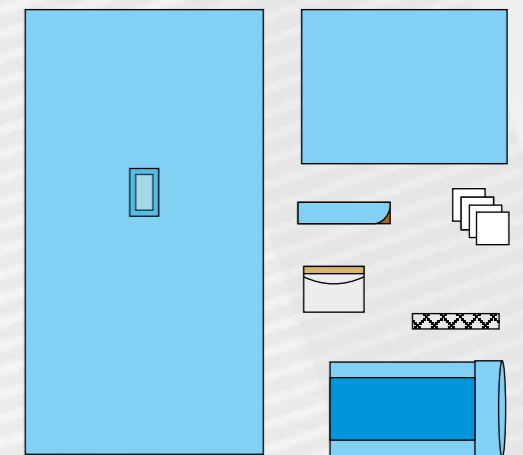

# Surgical Covers and Accessories

## Table Covers

Made of impermeable material FS2 or 2SBL.

Size (cm)	Ref FS2	Ref 2SBL
50 x 70	11-0102-S	51702-S
80 x 100	11-0136-S	51705-S
80 x 120	11-0137-S	51706-S
100 x 120	11-0132-S	51717-S
100 x 150	11-0116-S	51708-S
100 x 200	11-0174-S	51709-S
150 x 200	11-0117-S	51715-S

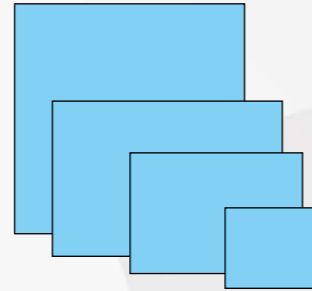

## MAYO Covers

Made of impermeable blue PE material, non-transparent, fitted with anti-slip surface and absorbent reinforcement. The size of the sack shaped cover is 80 x 145 cm.

Reinforced area (cm)	Reinf. Material	Ref
50 x 80	SB28	40-0101-S
70 x 80	SB28	40-0105-S
80 x 145	SB28	40-2001-S
50 x 145	DS2	40-0201-S
70 x 80	DS2	40-0205-S
80 x 145	DS2	40-2005-S
50 x 145	DS2	40-0209-S telescopic folding

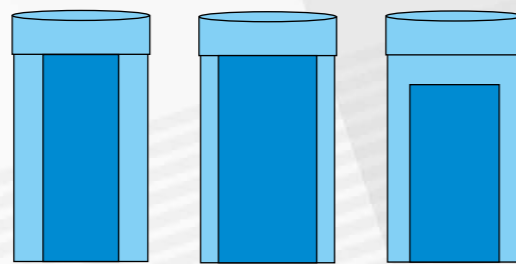

## Limb Covers

Sack shaped and usually made of laminated absorbent viscose – DS2. Used for easy limb covering during orthopaedic surgeries.

Size (cm)	Ref
30 x 60	50-0201-S
30 x 80	50-0202-S
40 x 120	50-0203-S

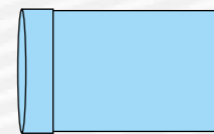

## URO and GYN Covers

Usually made of hydrophobic SMS material. Used for easy leg covering during transurethral or transvaginal surgeries.

Size (cm)	Ref
80 x 100	50-0102-S
80 x 120	50-0104-S



# BARRIER SYSTEM FOR SURGICAL THEATRES

## Set's Accessories

# Surgical Covers and Accessories

## Dinafix

Adhesive tube and cable holder on Velcro base.

Size (cm)	Ref
2,5 x 10	78-0117-S
2,5 x 15	78-0105-S
2,5 x 20	78-0101-S
2,5 x 25	78-0110-S
2,5 x 30	78-0106-S



## AT - Adhesive Tape

Adhesive tape with absorbent viscose on the top, used for tube fastening.

Size (cm)	Ref
5 x 30	70-0113-S
10 x 50	70-0101-S
10 x 70	70-0107-S
15 x 20	70-0105-S
15 x 50	70-0103-S

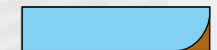

## Incise Foils

Adhesive polyurethane sterile foil used for covering operating area, reduces risk of wound contamination.

Size (cm)	Ref
10 x 15	76-0124-S
10 x 20	76-0113-S
15 x 20	76-0101-S
15 x 25	76-0102-S
35 x 40	76-0103-S
20 x 30	76-0104-S
45 x 50	76-0105-S
20 x 45	76-0106-S
25 x 30	76-0107-S
25 x 40	76-0108-S
25 x 50	76-0109-S
40 x 50	76-0110-S
40 x 65	76-0111-S
50 x 80	76-0112-S

## Device Covers

Made of PE foil, equipped with an elastic band for easy fastening. Protects device from contamination and keeps the surface sterile.

### Round Covers

Size (cm)	Ref
42,5 x 42,5	71-0106-S
50 x 60	71-0125-S
60 x 100	71-0115-S
60 x 120	71-0116-S
65 x 85	71-0103-S
70 x 70	71-0117-S
80 x 120	71-0118-S
80 x 160	71-0119-S
85 x 85	71-0102-S
85 x 95	71-0120-S
95 x 130	71-0121-S
100 x 120	71-0122-S
100 x 125	71-0104-S
105 x 105	71-0108-S
120 x 120	71-0111-S
140 x 140	71-0105-S
180 x 200	71-0107-S

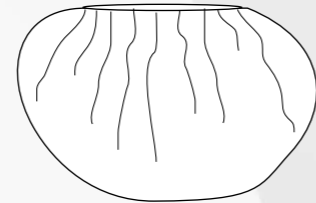

### Flat Covers

Size (cm)	Ref
70 x 80	75-0101-S
75 x 75	75-0102-S
80 x 150	75-0103-S
85 x 90	75-0104-S
90 x 100	75-0105-S
90 x 160	75-0106-S
100 x 115	75-0107-S
100 x 160	75-0108-S
120 x 150	75-0109-S

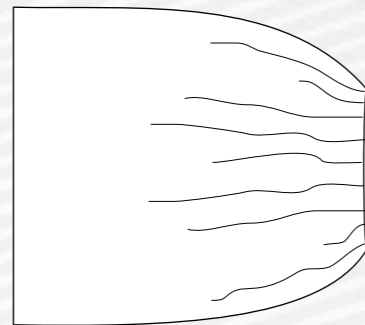

### Camera Covers

Ref	Size (cm)	Accessories
80-0101-S	14 x 250	Fixing tape, card cuffs
80-0105-S	14 x 145	Fixing tape, card cuffs
80-0109-S	14 x 250	Elastic tip, card cuffs

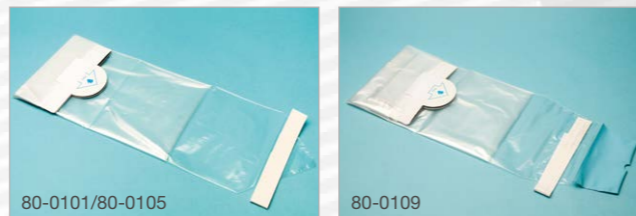

## BARRIER SYSTEM FOR SURGICAL THEATRES Set's Accessories

### Cord Covers

Ref	Size (cm)	Accessories
80-0103-S	8 x 120	Fixing tape
80-0108-S	8 x 120	Card cuff



### Ultra Sound Covers

Ref	Size (cm)	Accessories
80-0133-S	20 x 120	Adhesive tape, telescopic folding
80-0132-S	20 x 250	Adhesive tape, telescopic folding



### Drawstring Cover

2-Drawstring bag is made of the PE film 40 µm.

Ref	Size (cm)	Accessories
80-0135-S	70 x 80	2 drawstring sides



### C-Arm Covers - Universal

Made of transparent PE foil.

Designed as a one piece tube cover with fixing tapes or a three-part set.

The three-part set is composed of two 71-0111 covers and a PE sheet with 4 fixing tapes. Fixing tapes enable easy fastening around C-arm.

Ref	Size (cm)	Accessories
40-0334-S	120 x 180	Fixing tapes
40-0335-S	120 x 260	Fixing tapes
40-0337-S	120 x 200	three-part set

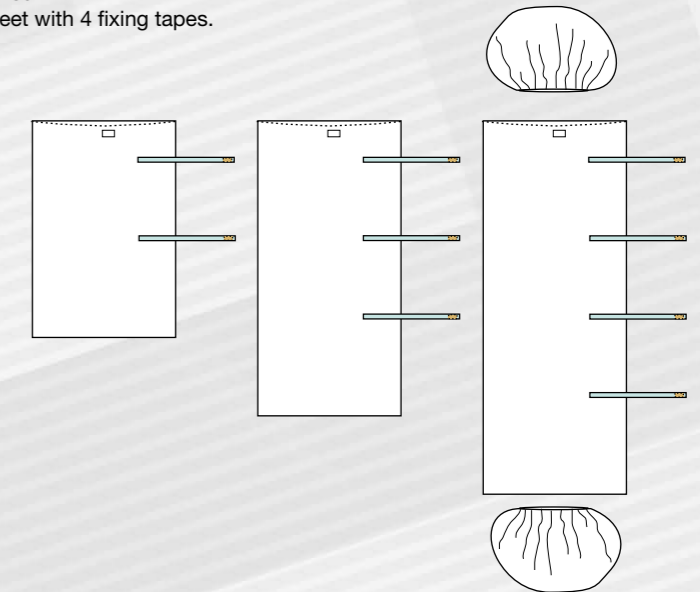

# Liquid Collection Pouches

## Adhesive Pouches

Designed to collect fluid from the surgery area. Pouches are made of strong PE transparent foil. Equipped with adhesive tape at the back side which ensures easy fastening to the drape. Front part of the pouch is equipped with a forming brace.

### 1-Compartment Pouch

Size (cm)	Ref
22 x 29	60-0101-S
28 x 44	60-0102-S
28 x 55	60-0103-S

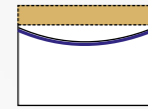

### 2-Compartment Pouch

Size (cm)	Ref
25 x 28	60-0124-S
28 x 44	60-0125-S

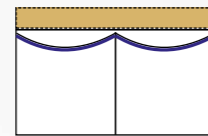

### 3-Compartment Pouch

Size (cm)	Ref
28 x 44	60-0149-S

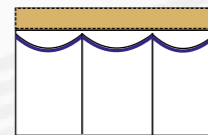

## Pouch for Neurosurgery

Adhesive tape and semi oval aperture on upper rear side edge enables perfect adjustment to the head shape. The front part with forming brace enables free fluid access into the pouch.

Size (cm)	Ref
30 x 32	60-0111-S

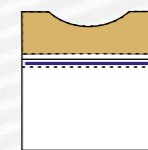

## Pouches with Filter

The rear side of the pouches is equipped with a 5 cm wide adhesive tape. The front part of the pouch is equipped with a forming brace. Conical drainage port for tube setting (6 - 10 mm in diameter) is equipped with a filter to prevent from clogging.

Ref	Size (cm)	Accessories
65-0101-S	50 x 50	Drainage, filter
65-0102-S	50 x 60	Drainage, filter
65-0106-S	60 x 90	Drainage, filter

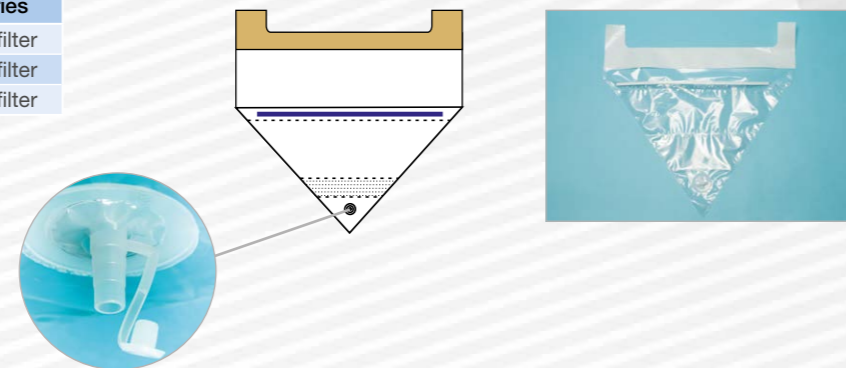

# BARRIER SYSTEM FOR SURGICAL THEATRES

## Set's Accessories

# Liquid Collecting Pouches

## Arthroscopic Pouches - Knee, Shoulder

Pouches are designed to collect fluid during knee or shoulder arthroscopy. They are made of strong PE foil, equipped with a conical drainage port for tube setting (6 - 10 mm in diameter) and a forming brace. Tight shape around the limb is ensured by 2 flexible elastic membranes with oval aperture 6 x 8 cm.

Ref	Size (cm)	Accessories
60-0122-S	60 x 100	2 elastic membranes



## Caesarean Pouches

Made of strong transparent PE foil. Pouches are equipped with an adhesive tape around the aperture. The front part has either a forming brace or a PUR foam brace to retain fluids safely. Pouches are accessoried with a conical drainage port for tube setting (6 - 10 mm in diam.) on both sides or with a sleeve outlet.

Ref	Size (cm)	Accessories
60-0106-S	80 x 100	PUR foam
60-0107-S	80 x 100	Plastic forming brace
60-0145-S	110 x 110	PE sleeve outlet



## Pouches for Gynaecology

They are made of strong PE foil as either 1-compartment or 2-compartment pouches. All pouches are equipped with a forming brace in front and an adhesive tape on rear side to be attached to the drape. Pouches are fitted with a conical drainage port or sleeve outlet and volume indicator.

Ref	Size (cm)	Accessories
60-0146-S	60 x 150	1 compartment, without scale, sleeve outlet
60-0153-S	60 x 100	1 compartment, with scale and drainage port
60-0148-S	60 x 100	2 compartments, with scale and drainage port

## BARRIER SYSTEM FOR SURGICAL THEATRES Set's Accessories

### Surgical gowns

#### Properties:

Surgical gowns provide high protection from body fluids as well as infection. Gowns are made from non-linting nonwoven hydrophobic material SMMMS or SPUNLACE, with antistatic treatment. Both materials are breathable and comfortable to wear. Gowns are of a tie-round type and fastened by the four tie system to keep the wearer aseptic. Sewn-in sleeves are finished with knitted elastic cuffs, the upper seam of sleeves is done by ultrasonic welding, as well as ties.

**Surgical gowns with reinforcement** – are equipped with a liquid proof material SBPE at both the front side and on sleeves. Although the material is laminated, it is breathable and provides high level of protection.

#### Neck Colour Differentiation indicates Gowns' liquid resistance:

<b>Blue</b>	low fluid contact surgery
<b>Yellow</b>	middle fluid contact surgery
<b>Green</b>	middle and high fluid contact surgery
<b>Red</b>	long-lasting and high fluid contact surgery



#### PRIMA

Made of hydrophobic non-woven textile SMS.

Size	PRIMA Ref	PRIMA Reinforced Ref	Length (cm)
M	354523-S	354623-S	115
L	354533-S	354633-S	125
XL	354543-S	354643-S	135
XXL	354553-S	354653-S	145
XXL-XL	354563-S	354663-S	160

#### CLASSIC

Made of hydrophobic non-woven textile SMMMS.

Size	CLASSIC Ref	CLASSIC Reinforced Ref	Length (cm)
M	351023-S	351123-S	115
L	351033-S	351133-S	125
XL	351043-S	351143-S	135
XXL	351053-S	351153-S	145
XXL-XL	351063-S	351163-S	160

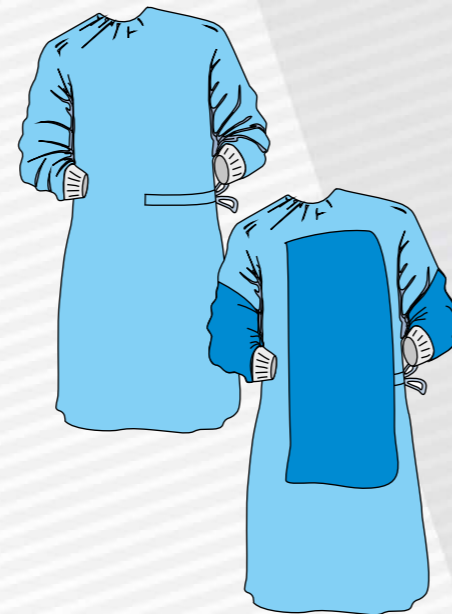

#### PREMIUM

Made of hydrophobic non-woven textile SPUNLACE. This type of gowns is designed for prolonged surgeries. Very comfortable to wear.

Size	PREMIUM Ref	PREMIUM Reinforced Ref	Length (cm)
M	350023-S	350123-S	125
L	350033-S	350133-S	135
XL	350043-S	350143-S	145
XXL	350053-S	350153-S	155

## DISPOSABLE CLOTHING FOR HOSPITALS

### Surgical Face Masks

- Surgical Face Masks Dina Standard Type II-white, with active silver particles in the filtration layer, non-sterile
- Bacterial Filtration Efficiency >99,5 %
- Viral Filtration Efficiency >99,6 %
- Tested in Nelson Laboratories, USA
- Made in Czech Republic
- Latex free
- Conform to EN 14683 Typ II standards
- CE

Surgical Face Masks Dina-Hitex are primarily used in hospitals and other medical facilities. At present, they are also in great demand for common use as a prevention against droplet transmission of infections.

Thanks to the highly efficient filtration layer, DINA-HITEX Face Masks provide maximum protection (more than 99%) against the penetration of bacteria and viruses and at the same time provide high comfort even when worn for longer periods. FM do not irritate the skin and are pleasant to breathe. The integrated shaping wire adapts well to your face shape.

DINA-HITEX Face Masks are intended for single use.

Place a clean FM on the face with a shaping wire upwards and shape it around the root of the nose with gentle pressure. Attach the ties around the head or the rubber band behind the ears and then spread the folds so that they completely cover the area of the nose and mouth.

Dispose of the used Face Mask.

#### Standard

Ref	Features	Packaging
20251 DH	<b>Three-layer surgical FM with ties</b> Thanks to the fixation around the head, it holds well during long-term surgical procedures.	50pcs/box, 500pcs/carton
20254 DH	<b>Three-layer surgical FM with elastics</b> The FM is fixed behind the ears and, thanks to its ease of use, is popular not only in hospitals, but also in gastronomy, cosmetics and common use during a day.	100pcs/box, 1000pcs/carton



#### Standard-Antireflex

Ref	Features	Packaging
20265 DH	<b>Three-layer surgical FM ANTIREFLEX with ties</b> Relieves the burden of vision in strong lighting in operating rooms. Recommended when using glasses. Thanks to the fixation around the head, it holds well during long-term surgical procedures.	50pcs/box, 500pcs/carton



#### Standard-Shield

Ref	Features	Packaging
23254 DH	<b>Three-layer surgical FM with elastics and a shield</b> Provides eye and upper face protection.	25pcs/box, 100pcs/carton



#### Goggles

Ref
92002



# Head Covers

## Clip

Simple cap with enclosing elastic band, suitable for health care staff and patients. Made of SB material.

Ref	Colour
10203	White
10213	Green
10223	Blue



## Barret Standard

Universal round shape cap with enclosing elastic band. Comfortable to wear, made of SB material.

Ref	Colour	Size
12202	White	M
12212	Green	M
12222	Blue	M
12204	White	XL
12214	Green	XL
12224	Blue	XL



## Barret Net

Made of absorbent high-permeable net material suitable for high temperature sites.

Ref	Colour	Size
12402	White	M



## Surgical Caps Standard and Comfort

Surgical cap Standard is made of SB material suitable for short-term surgeries. Surgical cap Comfort is made of absorbent printed viscose, in green, blue or white design. Its top is made of high-permeable net material. Comfort cap well absorbs sweat and is comfortable to wear during prolonged surgeries.

## Lady Standard and Comfort Caps

Female surgical cap with ties at the back, suitable for surgeons and theatre staff.

Ref	Lady	Colour
14212	Standard	Green
14222	Standard	Blue
14512	Comfort	Green
14522	Comfort	Blue



## Forest Standard and Comfort Cap

Surgical cap with ties at the back, suitable for surgeons and theatre staff.

Ref	Forest	Colour
15210	Standard	Green
15220	Standard	Blue
15510	Comfort	Green
15520	Comfort	Blue
15902	Comfort	White-smilings
15912	Comfort	Green-flowers
15922	Comfort	Blue-flowers



## Surgical Cap

Made of printed viscose.

Ref	Colour
17314	Green-flowers
17344	Blue-flowers
17354	White-smilings





Head Covers

Flip Standard and Comfort

Male surgical cap with elastic band at the back, suitable for surgeons and theatre staff.

Ref	Flip	Colour
16214	Standard	Green
16224	Standard	Blue
16614	Comfort	Green
16624	Comfort	Blue



Astro Comfort

Surgical hood covering head and neck.

Ref	Colour
13510	Green
13520	Blue



Hygienic and Protective Clothing

MEDIC II

Female nursing short dress, no pocket, V-neck, comfortable to wear. Made of non-linting non woven textile SMS, blue colour. Suitable for staff of operating theatres and laboratories.

Ref	Size
67423	M
67433	L
67443	XL
67453	XXL
67463	XXXL



MEDIC IV

Nursing dress, consists of a V-neck tunic with 3 pockets and tie waist trousers, comfortable to wear. Made of non linting non woven textile SMS, blue colour. Suitable for staff of operating theatres and laboratories.

Ref	Size
66913	S
66923	M
66933	L
66943	XL
66953	XXL



Patient's Gown

Fastened at patient's back by two ties at neck and waist position, sleeves with rubber endings. Suitable for some kinds of surgery, outpatient treatment and during ambulance transport etc. Made of non linting non woven textile SMS, blue colour. Comfortable to wear.

Ref	Size
30351	XXL



# Hygienic and Protective Clothing

## Visitor's Gown Standard

Fastened at visitor's back by two ties at neck and waist position, sleeves with rubber endings. Suitable for visitors of intensive care unit or isolation ward and patients during ambulance transport etc. Made of non linting non woven textile SB, comfortable to wear.

Ref	Size	Colour
30441	XL	White
30442	XL	Green
30451	XXL	White
30452	XXL	Green



## Nightshirt

Fastened with ties at the back. Made of non linting non woven textile SMS, blue colour. Comfortable to wear.

Ref	Size
67493	Uni



## Dressing Gown

Made of white spunbond.

Ref	Colour
39700	White



# Hygienic and Protective Clothing

## Colo-Shorts

Made of non woven textile SMS, blue colour. Examination opening for colonoscopy procedure at the back side.

Ref	Size
46232	L
46242	XL



## Patient's Skirt

Made of non woven textile SMS, blue colour. Elastic waist, one size. Suitable for gynecology examination.

Ref	Colour
69643	Blue



## Disposable Underwear

Lady's examination disposable bikini briefs. Made of soft white SB or blue SMS.

Size	Ref/White	Ref/Blue
M	95002	-
L	95003	95013
XL	95004	95014
XXL	-	95015



Size	Ref/White	
Uni	90841	women's thongs
Uni	90941	men's thongs



## Hygienic and Protective Clothing

### Shoe Covers

Shoe covers **Standard** with elastic are made of SB material. Shoe covers **Special** with elastic are made of liquid proof PE foil, fitted with anti-slip surface.

Ref	Shoe Cover	Size (cm)	Colour
30501	Standard	45	White
30505	Standard	50	White
31501	Special	36	Blue



### Slippers

Made of white SB.

Ref	Size
80140	Uni



### Cotton Socks

Socks are used for patients' warm comfort, fitted with anti-slip surface.

Ref	Colour	Size
47103	White	Uni



### Protective Apron

Made of liquid proof PE foil that protects from water/liquid splashing. Fastened at the back with ties.

Ref	Colour	Length (cm)
47501	White	125
47503	White	160



### Sleeve Covers

Made of liquid proof PE foil. Fastened with elastics at both ends.

Ref	Colour	Length (cm)
47101	White	40



## DISPOSABLE CLOTHING FOR HOSPITALS

## Hygienic Sheets, Bed Sheets and Bedding Sets

### Hygienic Sheets Hitex

Made of non-woven PP hydrophobic SB, non-irritant and non-allergenic material. Used as a protection of examination chairs and beds during outpatient treatment. Available in rolls from 45 up to 100 cm wide and either 100 m or 300 m long. Colour white and blue.

Width (cm)	Ref white 23 g 100 m	Ref white 23 g 300 m	Ref blue 28 g 100 m	Ref blue 28 g 300 m	Ref blue 17g 100 m	Ref blue 17g 300 m	Ref white 17 g 100 m	Ref white 17 g 300 m
45	50100	50400						
50	50101	50401	50121	50421			50101-B	50401-B
55	50102	50402	50122	50422	50102-M	50402-M		
60	50103	50403	50123	50423	50103-M	50403-M	50103-B	50403-B
70	50104	50404						
80	50105	50405						
100	50106	50406						



### Hygienic Sheets Hitex Pro

Made of highly absorbent 2ply laminated material, consists of cellulose and water proof PE film, provides maximum protection and comfort. Available in rolls, cross perforations ensure an easy tearing of the sheets.

Ref	HitexPro Colour	Sheet size (cm)	Sheets per roll
58102	Green	33 x 50	50
58103	Blue	33 x 50	50
58212	Green	51 x 50	80
58213	Blue	51 x 50	80
58222	Green	51 x 80	50
58223	Blue	51 x 80	50
58232	Green	51 x 160	25
58233	Blue	51 x 160	25



### Roll Towel

Made of absorbent MB. Available in rolls 108 m long, cross perforations ensure an easy tearing of the sheets.

Ref	Sheet size (cm)	Sheets per roll
96001	32 x 32	338



### Towel

Made of airlaid cellulose.

Ref	Size (cm)
P-3800-001	30 x 33cm



## Hygienic Sheets, Bed Sheets and Bedding Sets

### Bed Sheets

These bed sheets are cost-effective substitution of linen or cotton bed sheets during outpatient treatment or short term hospitalization. Made of non-irritant non woven textile either SB or SMS or water proof laminated material 2SBL and PE. 2SBL and PE provide an effective barrier against fluids penetration.

Ref	Size (cm)	Material	Colour
50801	80 x 220	SB23	White
50802	100 x 220	SB23	White
50807	160 x 240	SB40	White
50811	80 x 220	SB23	Green
50812	100 x 220	SB23	Green
50817	160 x 240	SB40	Green
50854	100 x 220	PE + elastic band	White
50801-SMS	80 x 220	SMMMS 50	Blue
50802-SMS	100 x 220	SMMMS 50	Blue
50801-SMS-35	80 x 220	SMS 35	Blue
51705	80 x 100	2SBL	Blue
51708	100 x 150	2SBL	Blue
51709	100 x 200	2SBL	Blue
51712	120 x 150	2SBL	Blue
51715	150 x 200	2SBL	Blue

### Stretcher's Pad Cover

Hygienic ambulance stretcher pad cover made of white SB. Fitted with open pleats for easy fastening on either side of the stretcher.

Ref	Material	Size (cm)
50501DH	SB23	60 x 190
50502DH	SB40	60 x 190

### Bedding Set Economic

This Set is cost-effective substitution of linen or cotton bed clothes during outpatient treatment or short term hospitalization. Made of non-irritant SB material.

Item	Ref	Colour
Bedding set Economic: consists of pillow case 70 x 80 cm, quilt case 155 x 200 cm, bed sheet 160 x 240 cm	59001	White
Bedding set Economic: consists of pillow case 70 x 80 cm, quilt case 155 x 200 cm, bed sheet 160 x 240 cm	59007	Green
• Quilt case 155 x 200 cm	56201	White
• Quilt case 155 x 200 cm	56202	Green
• Pillowcase 70 x 80 cm	55201	White
• Bed sheet 160 x 240 cm	50807	White

## Other Non-Sterile Products

### Body Cover Sheet

Black SB material.

Ref	Size (cm)
50821	160 x 220



### Patient Transfer Sheet

Facilitates safe and easy transfer of patients. Made of SB material, tested load up to 150 kg.

Ref	Size (cm)
40-0315	80 x 186

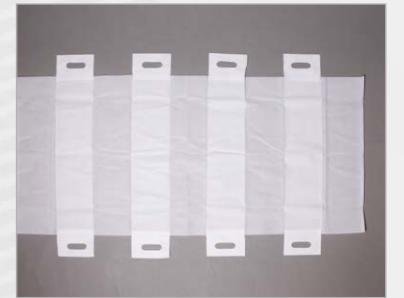

### Examination Gloves

Latex, slightly powdered, right-left.

Ref	Size
93101	S
93102	M
93103	L



### Vinyl/Nitrile Gloves

Size	Ref Vinyl
	powder free
S	93501
M	93502
L	93503
	Ref Nitrile
	powder free
S	93701
M	93702
L	93703



### Surgical Gloves Latex

Ref Slightly powdered	Ref No powder	Ref Size
93001	93011	6
93002	93012	6,5
93003	93013	7
93004	93014	7,5
93005	93015	8
93006	93016	8,5

**DINA-HITEX, spol. s r.o.**

Ždánská 987

685 01 Bučovice, Czech Republic

E-mail: [info@dina-hitex.com](mailto:info@dina-hitex.com)

+420 517 380 820

Tel. reception

Tel. orders Czech Republic +420 517 324 503

Tel. orders other countries +420 517 324 504

 **DINA - HITEX<sup>®</sup>**  
[www.dina-hitex.com](http://www.dina-hitex.com)