

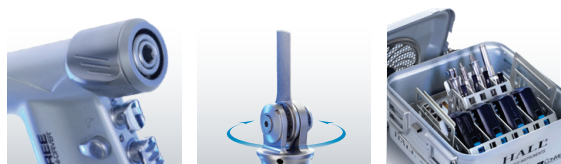

# Hall® Powered Instruments System

## Product Catalog



**HALL® MICROPOWER+**  
SMALL BONE HANDPIECE



**HALL® MICRO 100™**  
SURGAIROTOME TWO™

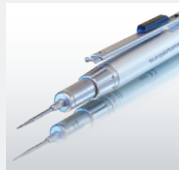

**M-CLASS™**  
BLADES



**HALL® LITHIUM**  
BATTERIES



**HALL®**  
POWERED INSTRUMENTS



Ordering Information.....	2	Attachments & Bur Guards .....	47
Product Support .....	3	For Use with Micro Handpieces .....	
Warranty Terms.....	4	Sterilization Trays.....	48
Return/Repair Information.....	5	For Use with Micro Handpieces .....	
Hall 50™ .....	6	Micro Sagittal Saw Blades .....	49- 54
Indications for Use: Large Bone & Small Bone Orthopedics		Micro Oscillating Saw Blades .....	55-57
MPower® 2 .....	7	Micro Reciprocating Saw Blades & Rasps.....	58
Indications for Use: Large Bone & Small Bone Orthopedics		Micro Burs .....	59-61
Batteries & Accessories .....	8, 9	Sternum Saws.....	62
PowerPro® & PowerPro Electric II™ .....	10	Sternum Saw Blades .....	63-65
Indications for Use: Large Bone & Small Bone Orthopedics		Indications for Use: Primary & Repeat Sternotomy	
PowerPro® Pneumatic .....	11	Ultrapower® .....	66, 67
Indications for Use: Large Bone & Small Bone Orthopedics		Indications for Use: Spine & Neuro	
Pin and Wire Drivers .....	12	UltraPower Burs .....	68-71
Indications for Use: Large Bone & Small Bone Orthopedics		Indications for Use: Otolaryngology (Round Burs Only), Spine & Neuro	
Attachments.....	13	E9000® System .....	72
Indications for Use: Large Bone & Small Bone Orthopedics		Indications for Use: ENT, Spine & Neuro	
Sterilization Trays.....	14	E9005 ENT Shaver Blades.....	73 -76
Indications for Use: Large Bone Orthopedics		Indications for Use: Sinus Surgery	
Hall® Pro Blades .....	15-17	E Burs.....	77, 78
Intrex® Blade System.....	18	Indications for Use: Otolaryngology, Spine & Neuro	
Indication for Use: Total Knee Arthroplasty		Osteon™ .....	79
M-Class® Blades .....	19	Indications for use: ENT	
Indication for Use: Total Knee Arthroplasty		Osteon Burs .....	80
Hall® Classic Blades .....	20	Indications for use: Otolaryngology	
Indication for Use: Total Knee Arthroplasty		Cebotome® .....	81
Large Bone Knee Blades.....	21-31	Indications for use: Large Bone Revision Surgery	
Indication for Use: Total Knee Arthroplasty		Cebotome® Burs & Metal Cutting Accessories.....	82
Stryker Replacement Blades .....	32, 33	Indication for Use: Large Bone Revisions Surgery	
Large Bone Oscillating Blades.....	34, 35	Wires & Staples.....	83
ACL Blades		Indication for Use: Small Bone Trauma	
Large Bone Oscillating Blades.....	36-39	Miscellaneous Accessories .....	84
Indications for Use: Total Joint Arthroplasty & Large Bone Trauma		Electric Consoles & Accessories.....	85, 86
Large Bone Reciprocating Blades.....	40, 41	Pneumatic Regulators, Hoses & Accessories .....	87
Indications for Use: Total Joint Arthroplasty & Large Bone Trauma		Kit Listings .....	88-91
Hall® MicroFree™ Power System .....	42, 43		
Indications for Use: Small Joint			
MicroPower™ + .....	44		
Indications for Use: Small Bone			
MicroPower® .....	45		
Indications for Use: Small Bone			
Micro 100™ .....	46		
Indications for Use: Small Bone			

## Terms

CONMED standard terms are net thirty (30) days, F.O.B. shipping point, unless otherwise approved in writing by CONMED. All orders and transactions are subject to the laws of the state of Florida.

## To Place Your Order

Please provide a purchase order number, billing and shipping instructions, product catalog number and description, valid CONMED quotation, and quantity and pricing to one of the following:

### Your Sales Representative

#### Customer Service

Phone: 800-237-0169

Fax: 727-399-5256

E-mail: [custserv1@CONMED.com](mailto:custserv1@CONMED.com)

### CONMED

Attn: Customer Service

11311 Concept Boulevard

Largo, FL 33773-4908 USA

## True Purchasing Flexibility

CONMED Financial Services offers a variety of flexible financing programs, from leases to Pre-Procedure Programs to delayed payment plans. Ask your Sales Representative for more information on how you can acquire the latest technology through a financing program that fits your unique budgetary requirements.

## Rental Program for Instrument Sets & Capital Equipment

In every O.R., there are times when you have to schedule a case but do not have the equipment needed. Either the capital funding for the equipment has yet to be approved or you have been unable to justify the cost of the equipment due to the procedure's low volume.

For these situations, CONMED offers a rental program for procedure-specific instruments and capital equipment. Simply call CONMED at 888-587-9742 and everything that you need for the case is on its way.

To enroll in a rental program, contact your Sales Representative or call the CONMED field inventory team. Your representative will help you customize the kit(s) to fit your procedural requirements. After the case, simply return the instruments, cleaned and sterilized if appropriate, along with any disposables you did not use. The rental fee will be billed for the disposables not returned, and customer will be responsible for any expedited shipping cost.

Failure to return instrumentation/equipment at the end of the rental period will result in the customer being charged the standard rental fee automatically for each week that the instrumentation/equipment is not received by CONMED.

At CONMED, we want to offer more than a quality product. We take pride in being able to provide you with value added services to support our products. The information given in this catalog is designed to address your questions regarding product support.

## Customer Support

If you encounter a problem or need technical assistance, contact Customer Service (Product Support) or your Sales Representative. Refer to the Customer Service telephone numbers listed on page 2.

## Regulatory Compliance

Report any injuries or malfunctions to CONMED Customer Service. Refer to the Customer Service telephone numbers listed on page 2.

## Original Warranty

CONMED (the “Company”) warrants to the first purchaser or lessee (“You” or “Customer”) that the instruments, attachments and parts manufactured by or for the Company (hereinafter collectively “Instruments”) have been tested, inspected, and shipped in proper working order.

The Company warrants all new instruments to be free from defects in materials and workmanship for the following periods, measured from date of sale\*:

<b>Product Categories</b>	<b>Months</b>
All Single Use Products.....	Upon Receipt
Powered Surgical Instruments.....	12
Power Attachments and Accessories.....	12
Handpiece Cords and Power Cords .....	6
Pneumatic Hoses .....	6
Bur Guards, Blade Guards, Attachments .....	6
Battery Packs, Power Units and Accessories .....	3
Battery Chargers .....	12
Camera Consoles .....	12
Video Components .....	12
Video Cables and Light Guides.....	3
Scopes .....	12
Camera Heads .....	12
Instruments.....	12
Instrument Trays.....	3
Footswitches .....	12
Irrigation Systems (Pumps and Remotes).....	12
Reusable Procedure Specific Instruments.....	6

Following the Original Warranty, CONMED offers SHIELD Service Programs that support our products throughout their lifetime. Service programs address the necessity to control cost and greatly reduce repair turnaround time. Products not covered under a service program are subject to variable repair charges. To find out which service option best meets your needs, contact your local Sales Representative.

## Service Agreements

Service Agreements provide additional service coverage on capital equipment. This additional warranty period covers all repair costs, periodic maintenance, free loaner usage during repair time and freight charges out from CONMED both on the loaner product and the repaired instrument.

## Service Warranty

After expiration of the original warranty period, instruments may be returned to CONMED for repair at the customer’s expense. CONMED warrants that any service or repair work performed by CONMED shall be free from defects in workmanship and materials for a period of 90 days after the date the customer receives the Instrument(s). This limited warranty applies only to the actual service or repair work performed by CONMED or its authorized service centers. CONMED warrants that all parts and assemblies used in the repair or service of Instruments meet new part functional specifications, although some parts or assemblies may have been remanufactured.

CONMED components are manufactured to exacting tolerances and design specifications. As a standard practice, all repairs are subject to strict product performance and testing specifications prior to returning the Instrument to the customer. CONMED ensures that each Instrument is inspected according to the guidelines used for new manufactured Instruments. If an Instrument is determined unrepairable, CONMED will offer to sell to the customer a refurbished or brand new Instrument or comparable equivalent at a preferential price. All parts and assemblies replaced by CONMED shall become the property of CONMED.

## Minimum Service Charge

There is a minimum repair charge for the evaluation and testing of all returns (except for products covered under warranty).

## Return Shipping

All repaired products will be returned to you via second day air delivery unless you request an alternate shipping method. The cost of return shipping is your responsibility unless the product is under warranty or service agreement.

\* Effective February 1, 2014

## Warranty Terms

If the customer discovers within the original warranty period that an Instrument has a defect in materials and/or workmanship, the customer must promptly notify the Company. Also, if the customer discovers within the service warranty period that any service or repair work performed by CONMED has a defect in workmanship and/or materials, the customer must promptly notify the Company. If it becomes necessary to return the Instrument to the Company, the customer must (a) acquire a "Service Request" (SR) authorization from the Company Customer Service Department, (b) pack the unit carefully, and (c) return it to the Company.

Within a reasonable time after receipt of the Instrument, the Company will investigate and correct any defect covered by warranty by providing, at its option, one of the following: service or repair of the Instrument, or replacement of the Instrument. All parts and assemblies replaced by CONMED shall become the property of CONMED. These remedies are the customer's exclusive remedies under the warranty.

### The foregoing limited warranties do not apply to:

- » Instruments that have been tampered with, altered, neglected, or misused
- » Instruments damaged through use with other than Company authorized accessories, attachments, burs or blades
- » Instruments not manufactured by or for the Company
- » Instruments used for purposes other than those for which they were designed and manufactured, including use in any way inconsistent with the instructions and warnings contained in the Company instruction manuals and package inserts
- » Instruments that were last serviced, refurbished, reprocessed or reconditioned by a nonauthorized service entity

**THE FOREGOING LIMITED WARRANTIES ARE IN LIEU OF ALL OTHER WARRANTIES, EXPRESS OR IMPLIED, INCLUDING, BUT NOT LIMITED TO, THE IMPLIED WARRANTIES OF MERCHANTABILITY AND FITNESS FOR A PARTICULAR PURPOSE.**

In no case shall the Company be liable for any special, incidental, indirect or consequential damages based upon breach of warranty or any other legal theory. Some jurisdictions do not allow limits on warranties, or on remedies, and, in such jurisdictions, the limits in this and the preceding paragraphs may not apply.

The Company reserves the right (a) to make design changes to Instruments at any time without notice to customer and without incurring any obligation to incorporate those changes into Instruments previously purchased or leased, and (b) to make changes from time to time in the contents of any publication, instruction manual or package insert without any obligation to notify customers of such revisions or changes, and (c) to change price without notice.

## U.S. Procedure for Returns/Repairs

1. All Instruments must be cleaned and decontaminated, if appropriate, prior to return of any Instrument to CONMED. Instruments contaminated with biohazardous materials will be returned to you at your expense.
2. An authorized Service Request (SR) Number must be obtained prior to returning any Instrument for repair/return.
3. To return a product for repair, contact CONMED Customer Service. The following information is needed to process a repair/return:
  - » Catalog Number
  - » Serial/Lot Number
  - » Original Invoice Number
  - » Detailed description of the problem or reason for return
4. The SR number must be displayed on the outside of the box, included with all paperwork, and must be referred to when making an inquiry about the status of a repair/return.
5. CONMED maintains various repair centers around the world. When you are issued your SR number, you will be advised of the location where to send your product.

## Return Terms

If it becomes necessary to return a product after purchase, the product must be returned within 45 days of its ship date. The product must be returned unused, in the original packaging and be restockable. Returns must be shipped prepaid freight. Returns that are not shipped prepaid freight will not be accepted. All product returns, except those attributable to a CONMED error, are subject to a restocking fee of 15% of the purchase price or \$25, whichever is greater.

### Products Not Eligible for Credit:

- » Sterile products/single use devices returned with the outer packaging seals broken
- » Non-sterile products that have been sterilized and/or placed in the surgical field
- » Products damaged by customer misuse or negligence
- » Altered or customized products
- » Products damaged in return transit due to inadequate packaging
- » Less than full packages – all products must be in original packaging
- » Obsolete products

### Packaging

Whenever it is required to return your product, be sure to package it in a protective carton. We recommend that you save the original shipping container for this purpose. In-transit damage is not covered by the warranty; therefore, it is best to always insure shipments.

# Hall 50™

Indications for Use: Large Bone  
& Small Bone Orthopedics



**PRO7100B**



**PRO7200B**



**PRO7300B**



**PRO7400B**

*Attachments Listed on Pages 12 and 13*

**Cat. No.**

Hall 50™ 1-Trigger Modular Handpiece .....PRO7100B

Hall 50™ 2-Trigger Modular Handpiece .....PRO7200B

Hall 50™ Oscillating Saw Handpiece .....PRO7300B

Hall 50™ Reciprocating Saw Handpiece .....PRO7400B

All products may not be available in all markets.



Attachments Listed on Pages 12 and 13

	<b>Cat. No.</b>
MPOWER <sup>®</sup> 2 1-Trigger Modular Handpiece.....	PR06200M
MPOWER <sup>®</sup> 2 2-Trigger Modular Handpiece .....	PR06202M

MPOWER<sup>®</sup> 2 Oscillating Saw .....PR06350M

MPOWER<sup>®</sup> 2 Reciprocating Saw .....PR06400M



**PR06200M**

**PR06202M**



**PR06350M**



**PR06400M**

All products may not be available in all markets.



**L3000**

Hall® Lithium Charger ..... **Cat. No.** L3000



**L3000SM**

Hall® Large Lithium Battery, 13.2 Volt ..... L3000LG



**L3000LG**

Hall® Small Lithium Battery, 13.2 Volt ..... L3000SM



**PRO3600**

NiCad Battery Charger ..... PRO3600



**PRO3010**

Large NiCad Battery, 9.6 Volt ..... PRO3010



**PRO3011**

X-Large NiCad Battery, 12 Volt ..... PRO3011

All products may not be available in all markets.

	<b>Cat. No.</b>
Small NiMH Sterile Transfer Battery, 12 Volt .....	PRO3520
Large NiMH Sterile Transfer Battery, 9.6 Volt.....	PRO3115

Battery Case for PRO3520 .....	PRO3521
Battery Case for PRO3115.....	PRO3110

Transfer Shroud for PRO3521 .....	PRO3531
Transfer Shroud for PRO3110 .....	PRO3130

Charging Platform for PRO3520.....	PRO3535
Charging Platform for PRO3115 .....	PRO3135



**PRO3520**



**PRO3115**



**PRO3521**



**PRO3110**



**PRO3531**



**PRO3130**



**PRO3535**



**PRO3135**

All products may not be available in all markets.

# PowerPro® & PowerPro Electric II™

Indications for Use: Large Bone  
& Small Bone Orthopedics



**PRO6100**

*Attachments Listed on Pages 12 and 13*

**Cat. No.**

PowerPro® Electric II 1-Trigger Modular Handpiece.....PR06100



**PRO6125**

PowerPro® Electric II Oscillating Saw.....PR06125



**PRO6135**

PowerPro® Electric II Reciprocating Saw.....PR06135

All products may not be available in all markets.

Attachments Listed on Pages 12 and 13

PowerPro® Pneumatic Single Trigger Modular Handpiece..... **Cat. No.** PRO6150



**PRO6150**

PowerPro® Pneumatic Oscillating Saw..... PRO6175



**PRO6175**

PowerPro® Pneumatic Reciprocating Saw..... PRO6185



**PRO6185**

All products may not be available in all markets.

# Pin and Wire Drivers

Indications for Use: Large Bone  
& Small Bone Orthopedics



**PRO6128**



**PRO6132**



**PRO6132-4**



**PRO6140**



**PRO6228**



**PRO6232**



**PRO6232-4**



**PRO6240**

## 1-Trigger Wire and Pin Drivers

	Range	Cat. No.
Wire Driver	0.7 – 1.6mm (0.028 – 0.062")	PRO6128
Pin Driver	2.0 – 3.2mm (0.078 – 0.125")	PRO6132
Pin Driver	2.0 – 4.0mm (0.078 – 0.156")	PRO6132-4
Pin Driver	1.8 – 4.0mm (0.071 – 0.157")	PRO6140

## 2-Trigger Wire and Pin Drivers

Wire Driver	0.7 – 1.6mm (0.028 – 0.062")	PRO6228
Pin Driver	2.0 – 3.2mm (0.078 – 0.125")	PRO6232
Pin Driver	2.0 – 3.2mm (0.078 – 0.125")	PRO6232-4
Pin Driver	1.8 – 4.0mm (0.071 – 0.157")	PRO6240

All products may not be available in all markets.

## Drill-Ream 1:1/5:1 Combination Attachments

1/2" (4.0mm) Jacobs Chuck, with Chuck Key... <b>PRO2030</b>	Drill-Ream Attachment, 1/4" (6.35mm) Chuck ... <b>PRO1541</b>	Drill-Ream Attachment, Zimmer/Hudson..... <b>CPR01547</b>	Drill-Ream Attachment, DePuy/Hudson ..... <b>PRO1541</b>

## 1:1 Multipurpose Attachments

1/2" (4.0mm) Jacobs Chuck, with Chuck Key ..... <b>PRO2030</b>	1/2" (4.0mm) Jacobs Chuck, with Chuck Key..... <b>5044-999-53</b>	1/4" (6.35mm) Jacobs Chuck..... <b>PRO2041</b>	1/4" (6.35mm) Replacement Chuck Key ..... <b>5044-999-52</b>	1/4" Keyless Chuck..... <b>PRO6050</b>	1/4" Keyless Chuck..... <b>PRO2250</b>

## 1:1 Quick Connect Drill Attachments

AO/Trinkle ..... <b>PRO2029</b>	Small AO-Low Profile..... <b>PRO2038</b>	Zimmer/Hudson..... <b>PRO2046</b>	Large AO ..... <b>PRO2070</b>	Standard Hudson (DePuy) <b>PRO2075</b>	Mini AO..... <b>PRO2039</b>	Small AO-One Handed Operation..... <b>PRO2138</b>

## 3:1 Reamers

3:1 1/4" High Torque Jacobs Chuck..... <b>PRO2042</b>	3:1 Zimmer/Hudson Reamer <b>PRO2047</b>	3:1 Hudson Reamer (DePuy) <b>PRO2065</b>	3:1 Large AO Reamer <b>PRO2040</b>	3:1 Aesculap Reamer <b>PRO2060</b>	3:1 DHS Reamer <b>PRO2080</b>	3:1 Trinkle Reamer <b>PRO2329</b>

## 5:1 Reamers

5:1 1/4" High Torque Jacobs Chuck... <b>PRO6042</b>	5:1 Zimmer/Hudson Reamer ..... <b>PRO6047</b>	5:1 Hudson Reamer(DePuy) ..... <b>PRO6048</b>	5:1 Large AO Reamer ..... <b>PRO6040</b>	5:1 Aesculap Reamer..... <b>R06060</b>

## Miscellaneous Attachments

Radiolucent Drive Adaptor... <b>PRO2514</b>	High Speed Drill Attachment... <b>PRO2033</b>	Sagittal Saw Attachment..... <b>PRO2043</b>	Multipurpose High Speed.... <b>PRO7020</b>	Reciprocating Saw Attachment for PRO6100, PRO6150, PRO6200M, PRO6202M..... <b>PRO2065</b>

All products may not be available in all markets.

# Sterilization Trays

Indications for Use: Large Bone Orthopedics

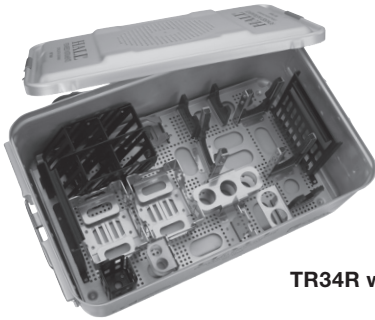

**TR34R with PRO7000T**



**TR34R with PRO7001T,  
and PRO7002T**



**TR12R with PRO7001T**



**TR12R with PRO7002T**

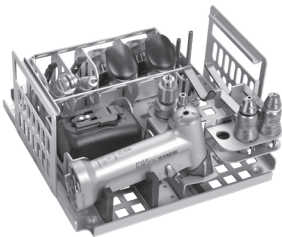

**PRO8001T**

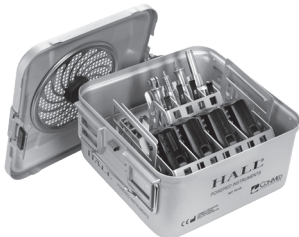

**TR12R with PRO8003T**

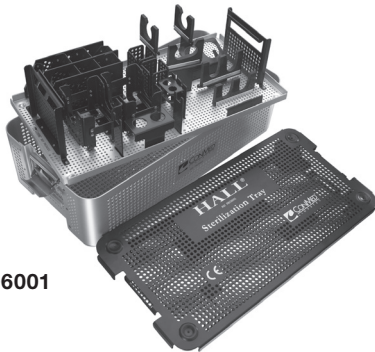

**PRO6001**

## Hall® Sterilization Containers/Inner Trays

Cat. No.

¾ Size Rigid Sterilization Container .....	TR34R
½ Size Rigid Sterilization Container .....	TR12R

## Hall® Sterilization Inner Trays

¾ Size Inner Tray, Full Set .....	PRO7000T
½ Size Inner Tray, Drill Set .....	PRO7001T
½ Size Inner Tray, Saw Set .....	PRO7002T
½ Size Inner Tray, Drill Set .....	PRO8003T
½ Size Inner Tray, Drill Set with Mini-Driver .....	PRO8001T

MPower® 2, Large Bone Tray with Battery Holders .....	PRO6001
---	---------

All products may not be available in all markets.



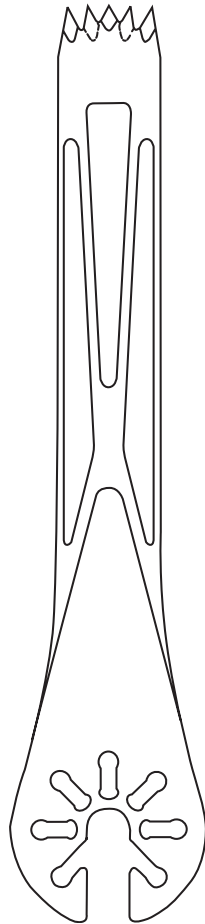

**5071-582**



**5071-263**



**5071-262**

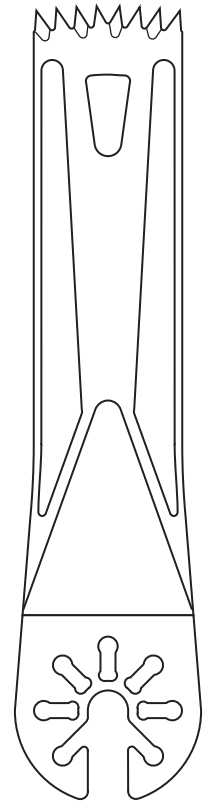

**5071-185**

Blade images are 1:1 in length and width.

**BOLD** =Chromium Coated

Body Width	13.0mm	14/8mm	14.0mm	14.0mm	19.5mm
Length	90.0mm	75.0mm	75.0mm	90.0mm	80.0mm
<b>Thickness</b>	<b>Blade Catalog #</b>				
0.09mm					<b>5071-185</b> <b>5071-195</b>
1.19mm		<b>5071-263</b>		<b>5071-261</b>	
1.27mm	5071-582	<b>5071-264</b>	<b>5071-262</b>		
1.37mm		<b>5071-265</b>			

All products may not be available in all markets.

# Hall® Pro Blades

Indication for Use: Total Knee Arthroplasty

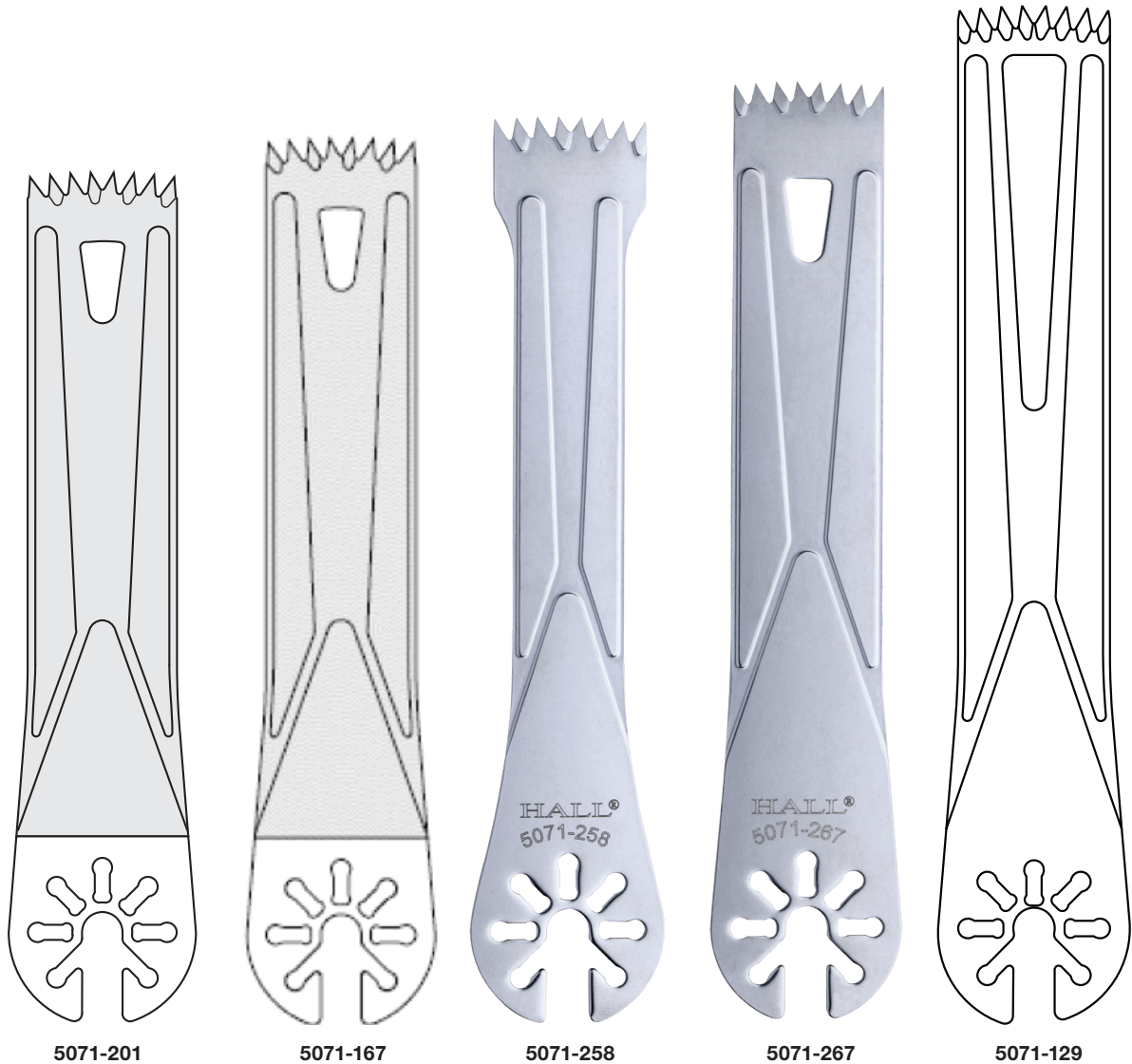

5071-201

5071-167

5071-258

5071-267

5071-129

Blade images are 1:1 in length and width.

**BOLD** = Chromium Coated

Body Width	19.5mm	19.5mm	19.5/14mm	19.5mm	19.5mm
Length	86.0mm	90.0mm	90.0mm	95.0mm	105.0mm
Thickness	Blade Catalog #				
1.19mm			<b>5071-257</b>		
1.20mm		5071-184 <b>5071-167</b>			
1.27mm	5071-181 <b>5071-201</b>		<b>5071-258</b>	5071-123 <b>5071-267</b>	5071-129
1.37mm			<b>5071-259</b>		

All products may not be available in all markets.

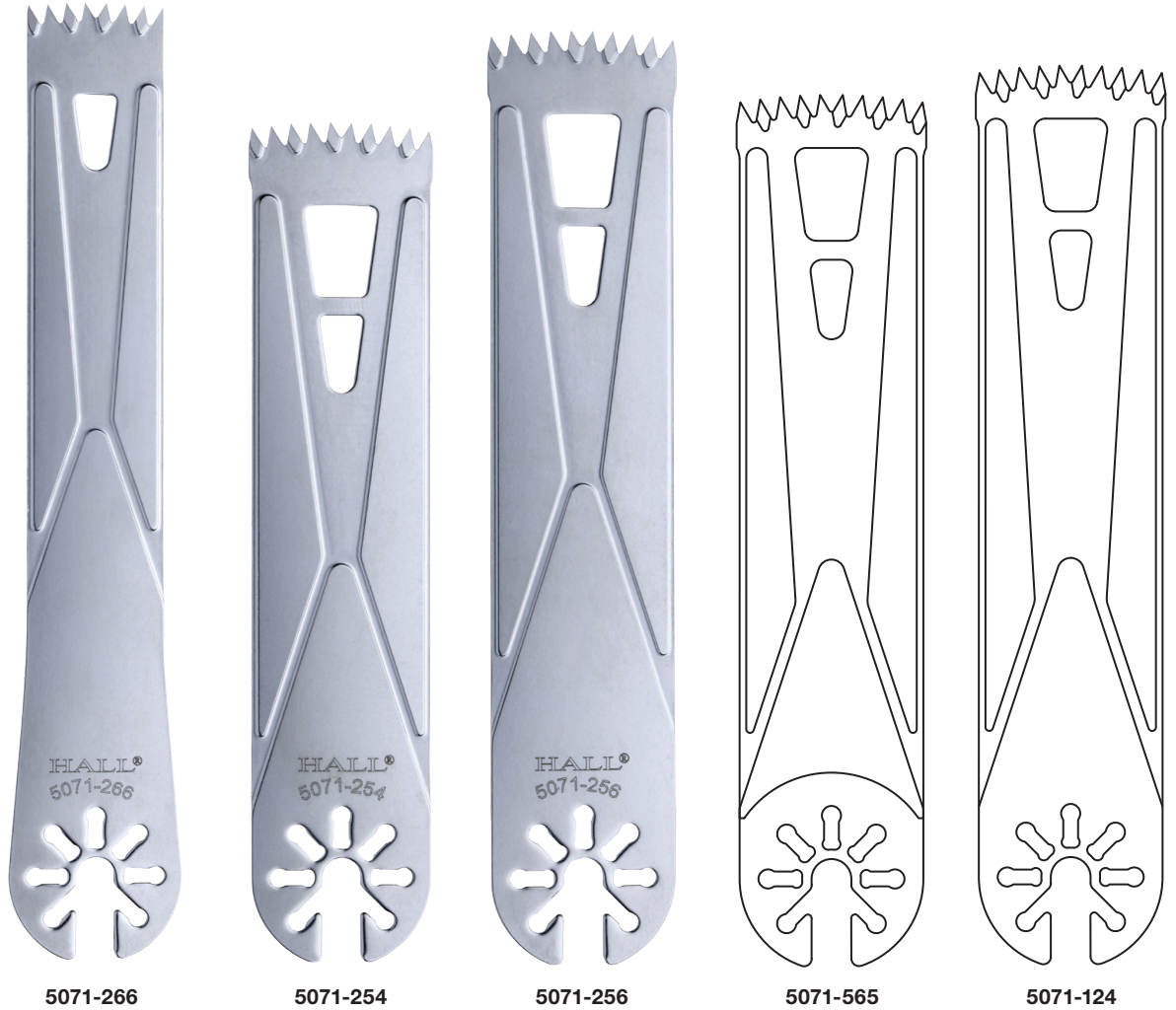

Blade images are 1:1 in length and width.

**BOLD** =Chromium Coated

Body Width	19.5mm	25mm	25mm	25.4mm	25.4mm
<b>Length</b>	110.0mm	90.0mm	100.0mm	90.0mm	95.0mm
<b>Thickness</b>	<b>Blade Catalog #</b>				
.09mm				5071-196	5071-121
1.0mm				5071-562	
1.19mm		<b>5071-252</b>	<b>5071-255</b>		
1.27mm		<b>5071-253</b>	<b>5071-256</b>	5071-161	5071-124
1.37mm	<b>5071-266</b>	<b>5071-254</b>		5071-163	
1.47mm				<b>5071-565</b>	
1.5mm				<b>5071-144</b>	

All products may not be available in all markets.

# Intrex® Blade System

Indication for Use: Total Knee Arthroplasty

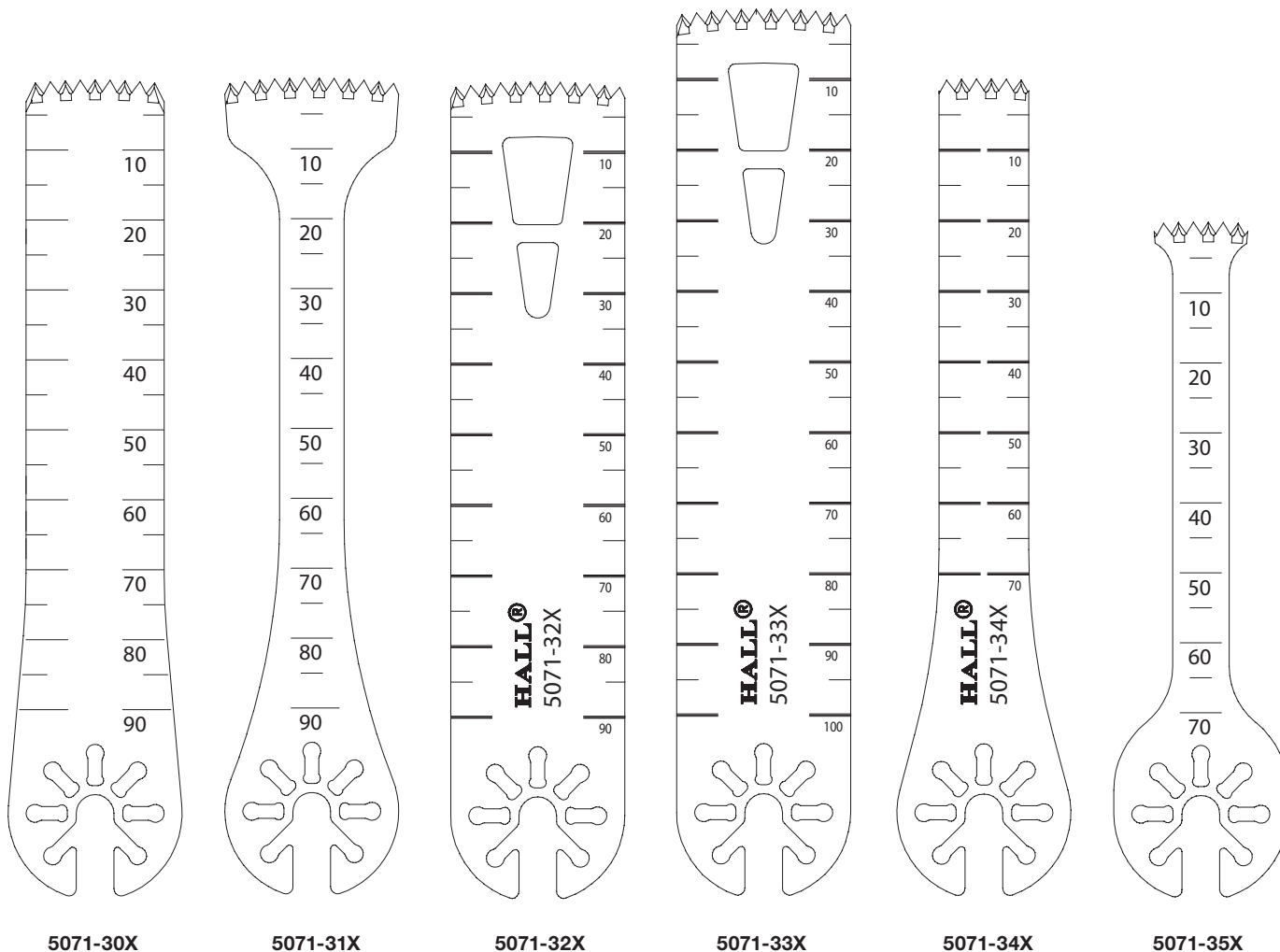

Blade images are 1:1 in length and width.

	Standard	MIS	Standard/ Wide	Standard/Long	Standard / Narrow	Unicondylar
<b>Head Width</b>	19.5mm	25.0mm	25.0mm	25.0mm	12.5mm	13.0mm
<b>Body Width</b>	19.5mm	9.0mm	25.0mm	25.0mm	12.5mm	8.0mm
<b>Length</b>	90.0mm	90.0mm	90.0mm	100.0mm	90.0mm	70.0mm
<b>Thickness</b>	<b>Blade Catalog #</b>					
0.89mm	5071-300		5071-320	5071-330	5071-340	5071-350
1.00mm	5071-301	5071-311	5071-321	5071-331	5071-341	5071-351
1.07mm	5071-302		5071-322	5071-332	5071-342	
1.19mm	5071-303	5071-313	5071-323	5071-333	5071-343	5071-353
1.27mm	5071-304	5071-314	5071-324	5071-334	5071-344	5071-354
1.37mm	5071-305	5071-315	5071-325	5071-335	5071-345	
1.47mm	5071-306	5071-316	5071-326	5071-336	5071-346	5071-356

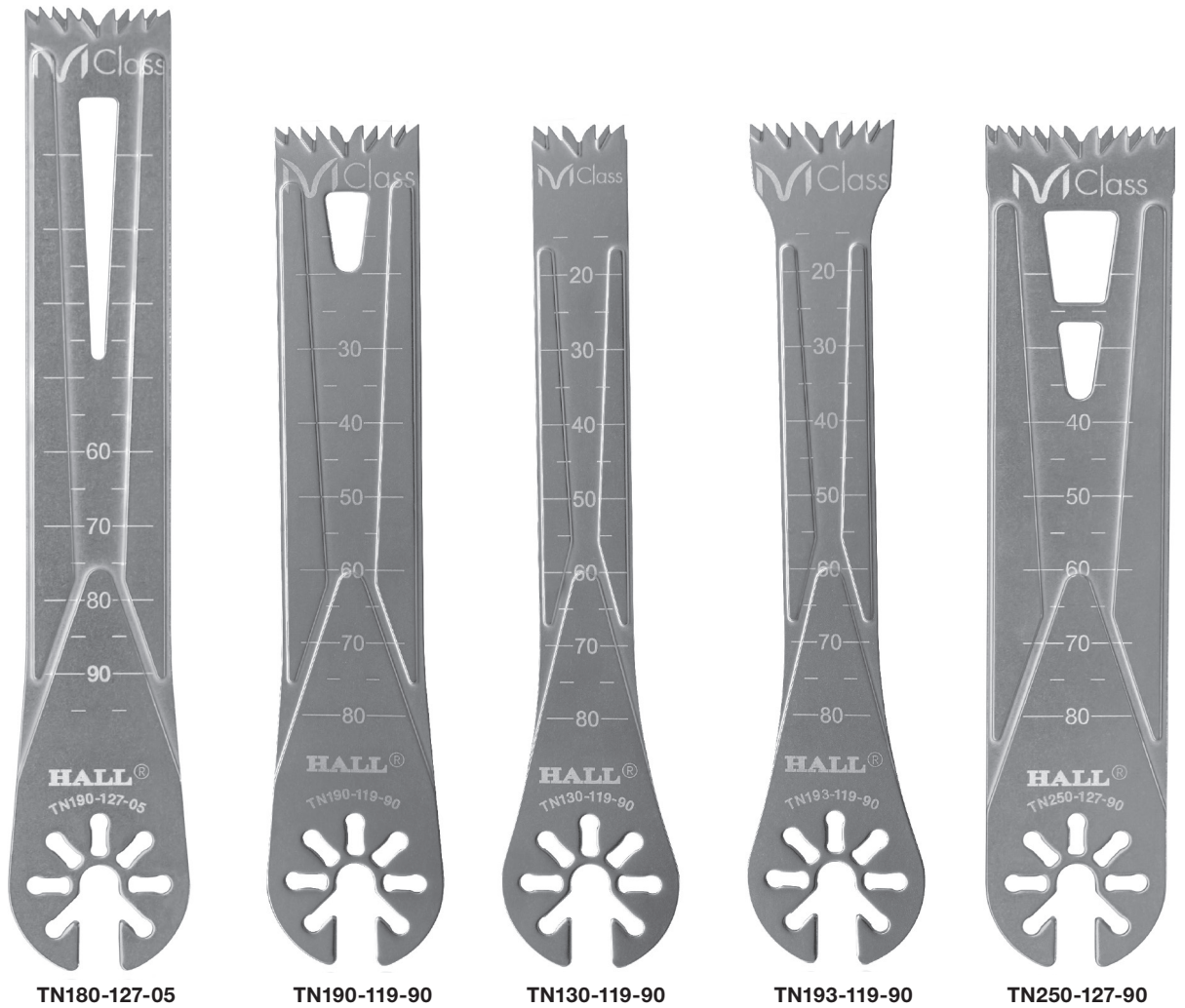

Blade images are 1:1 in length and width.

	Standard	Standard/ Wide	Standard/Long	Standard / Narrow	Unicondylar
<b>Body Width</b>	19.0mm	19.0mm	13.0mm	19.0/13.0mm	25.0mm
<b>Length</b>	105.0mm	90.0mm	90.0mm	90.0mm	90.0mm
<b>Thickness</b>	<b>Blade Catalog #</b>				
0.89mm		TN190-089-90	TN130-089-90		TN250-089-90
1.00mm		TN190-100-90	TN130-100-90		TN250-100-90
1.07mm		TN190-107-90	TN130-107-90		TN250-107-90
1.19mm	TN190-119-05	TN190-119-90	TN130-119-90	TN193-119-90	TN250-119-90
1.27mm	TN190-127-05	TN190-127-90	TN130-127-90	TN193-127-90	TN250-127-90
1.37mm	TN190-137-05	TN190-137-90	TN130-137-90	TN193-137-90	TN250-137-90
1.47mm		TN190-147-90	TN130-147-90		TN250-147-90

All products may not be available in all markets.

# Hall® Classic Blades

Indication for Use: Total Knee Arthroplasty

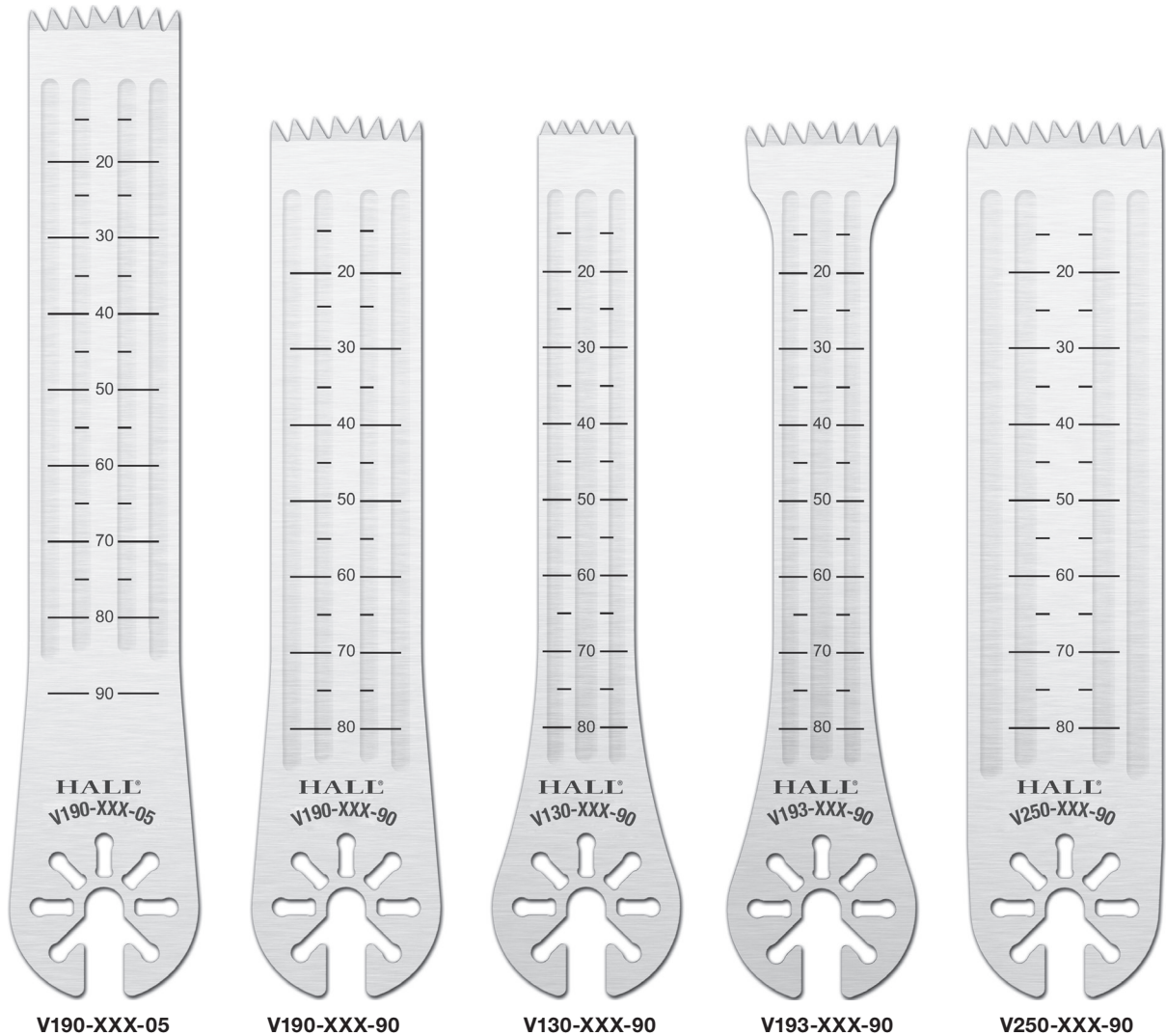

Blade images are 1:1 in length and width.

Body Width	19.0mm	19.0mm	13.0mm	19.0/3.0mm	25.0mm
<b>Length</b>	105.0mm	90.0mm	90.0mm	90.0mm	90.0mm
<b>Thickness</b>	<b>Blade Catalog #</b>				
0.89mm	V190-089-05	V190-089-90	V130-089-90		V250-089-90
1.00mm	V190-100-05	V190-100-90	V130-100-90		V250-100-90
1.07mm	V190-107-05	V190-107-90	V130-107-90		V250-107-90
1.19mm	V190-119-05	V190-119-90	V130-119-90	V193-119-90	V250-119-90
1.27mm	V190-127-05	V190-127-90	V130-127-90	V193-127-90	V250-127-90
1.37mm	V190-137-05	V190-137-90	V130-137-90	V193-137-90	V250-137-90
1.47mm	V190-147-05	V190-147-90	V130-147-90		V250-147-90

All products may not be available in all markets.

## Hall® Blades

Thickness: 0.60mm					
Cat. No.	Width (mm)	Length (mm)	Material Thickness (mm)	Cut Thickness (mm)	
5071-650	49.00	63.00	0.60	0.60	
Thickness: 0.64mm					
5071-594	29.46	58.70	0.64	0.64	
5271-502	29.00	74.00	0.64	0.64	
Thickness: 0.89mm					
5071-528	25.00	73.00	0.89	0.89	
5071-533	21.00	84.50	0.89	0.89	
5071-583	12.70	90.00	0.89	0.89	

All products may not be available in all markets.

# Large Bone Knee Blades

Indication for Use: Total Knee Arthroplasty



## Hall® Blades

Thickness: 0.89mm					
Cat. No.	Width (mm)	Length (mm)	Material Thickness (mm)	Cut Thickness (mm)	
5071-589	13.00	90.00	0.89	0.89	
Thickness: 0.90mm					
5071-532	12.00	80.00	0.90	0.90	
5071-185	19.50	80.00	0.90	0.90	
5071-195	19.50	80.00	0.90	0.90	
5071-146	25.40	90.00	0.90	0.90	
5071-196	25.40	90.00	0.90	0.90	
5071-120	19.50	95.00	0.90	0.90	

All products may not be available in all markets.

Grey shaded blades indicate coating.



## Hall® Blades

Thickness: 0.90mm					
Cat. No.	Width (mm)	Length (mm)	Material Thickness (mm)	Cut Thickness (mm)	
5071-121	25.40	95.00	0.90	0.90	
Thickness: 1.00mm					
5071-562	25.40	90.00	1.00	1.00	
5071-538	25.40	95.00	1.00	1.00	
Thickness: 1.19mm					
5071-548	12.70	86.00	1.19	1.19	
5071-547	25.40	86.00	1.19	1.19	
Thickness: 1.20mm					
5071-167	19.50	90.00	1.20	1.20	
5071-184	19.50	90.00	1.20	1.20	

Grey shaded blades indicate coating.

All products may not be available in all markets.

# Large Bone Knee Blades

Indication for Use: Total Knee Arthroplasty



## Hall® Blades

					Thickness: 1.24mm
Cat. No.	Width (mm)	Length (mm)	Material Thickness (mm)	Cut Thickness (mm)	
5071-558	18.50	73.00	1.24	1.24	
5071-534	25.40	79.50	1.24	1.24	
5071-570-50	25.00	95.00	1.24	1.24	
5071-526	18.50	107.00	1.24	1.24	
					Thickness: 1.26mm
5071-573	18.50	90.00	1.26	1.26	
5071-575	31.00	90.00	1.26	1.26	

All products may not be available in all markets.

## Hall® Blades

Thickness: 1.27mm					
Cat. No.	Width (mm)	Length (mm)	Material Thickness (mm)	Cut Thickness (mm)	
5071-527	19.00	80.00	1.27	1.27	
5071-180	10.00	85.00	1.27	1.27	
5271-580	10.00	85.00	1.27	1.27	
5071-531	25.40	85.00	1.27	1.27	
5071-181	19.50	86.00	1.27	1.27	
5071-201	19.50	86.00	1.27	1.27	
5071-582	13.00	90.00	1.27	1.27	

Grey shaded blades indicate coating.

All products may not be available in all markets.

# Large Bone Knee Blades

Indication for Use: Total Knee Arthroplasty



## Hall® Blades

Thickness: 1.27mm					
Cat. No.	Width (mm)	Length (mm)	Material Thickness (mm)	Cut Thickness (mm)	
5071-161	25.40	90.00	1.27	1.27	
5071-564	25.40	90.00	1.27	1.27	
5271-561	25.40	90.00	1.27	1.27	
5071-590	13.00	95.00	1.27	1.27	
5071-568	16.50	95.00	1.27	1.27	
5071-576	16.50	95.00	1.27	1.27	
5071-123	19.50	95.00	1.27	1.27	

All products may not be available in all markets.

## Hall® Blades

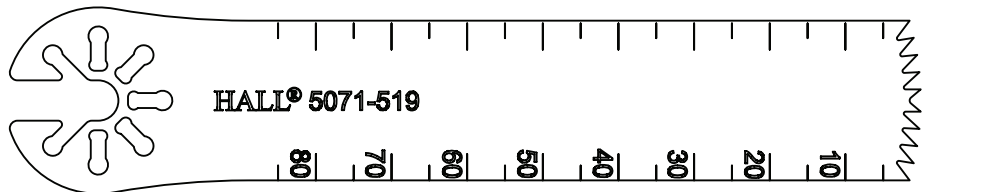
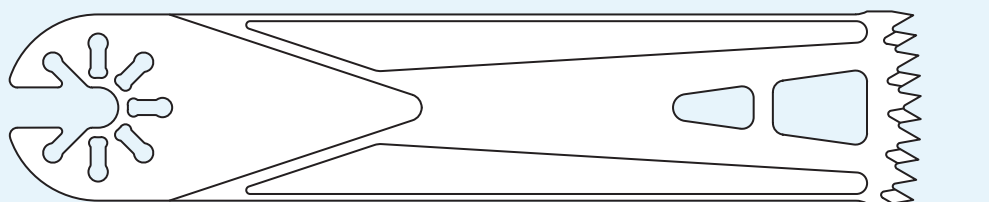
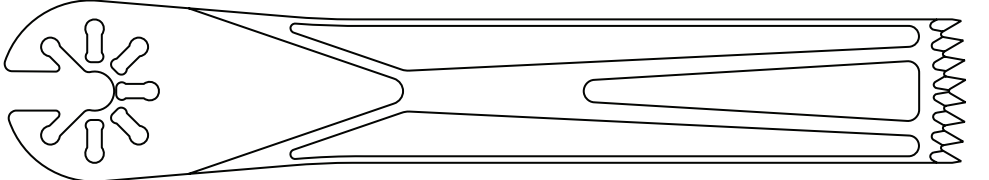
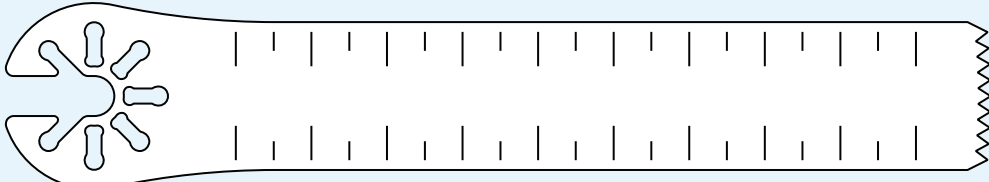
Thickness: 1.27mm					
Cat. No.	Width (mm)	Length (mm)	Material Thickness (mm)	Cut Thickness (mm)	
5071-519	21.00	95.00	1.27	1.27	
5071-124	25.40	95.00	1.27	1.27	
5071-129	19.50	105.00	1.27	1.27	
5071-529	19.50	105.00	1.27	1.27	

# Large Bone Knee Blades

Indication for Use: Total Knee Arthroplasty



## Hall® Blades

Thickness: 1.37mm					
Cat. No.	Width (mm)	Length (mm)	Material Thickness (mm)	Cut Thickness (mm)	
5071-163	25.40	90.00	1.37	1.37	
5071-525	19.00	95.00	1.37	1.37	
5071-530	19.00	95.00	1.37	1.37	
5071-539	25.40	95.00	1.37	1.37	
Thickness: 1.47mm					
5071-565	25.40	90.00	1.47	1.47	
Thickness: 1.50mm					
5071-144	25.40	90.00	1.50	1.50	

All products may not be available in all markets.

Grey shaded blades indicate coating.

## Stryker® Blades

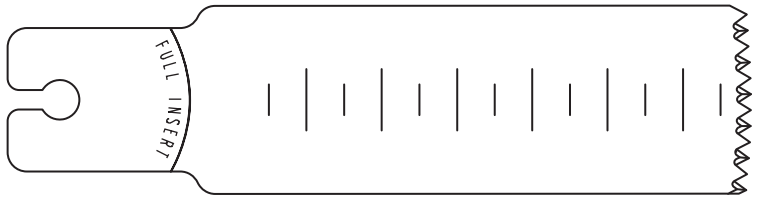
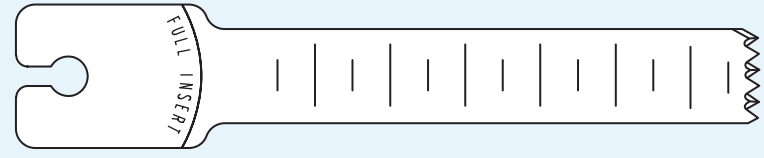
Thickness: 0.64mm					
Cat. No.	Width (mm)	Length (mm)	Material Thickness (mm)	Cut Thickness (mm)	
5072-100	25.00	73.79	0.64	0.64	
5072-150	12.50	73.80	0.64	0.64	

# Large Bone Knee Blades

Indication for Use: Total Knee Arthroplasty



## Stryker® Blades

Thickness: 0.89mm					
Cat. No.	Width (mm)	Length (mm)	Material Thickness (mm)	Cut Thickness (mm)	
5072-109	20.70	85.04	0.89	0.89	
5072-102	24.82	90.47	0.89	0.89	
Thickness: 0.90mm					
5072-195	19.50	80.00	0.90	0.90	
Thickness: 1.20mm					
5072-152	12.50	82.18	1.20	1.20	
5072-151	25.00	85.67	1.20	1.20	

All products may not be available in all markets.

Stryker® Blade is a trademark of Stryker  
Grey shaded blades indicate coating.



## Stryker® Blades

Thickness: 1.24mm					
Cat. No.	Width (mm)	Length (mm)	Material Thickness (mm)	Cut Thickness (mm)	
5072-185	18.50	104.00	1.24	1.24	
Thickness: 1.27mm					
5072-110	24.82	73.79	1.27	1.27	
5072-111	24.82	80.14	1.27	1.27	
5072-158	12.50	82.20	1.27	1.27	
5072-101	19.50	86.00	1.27	1.27	
5072-181	19.50	86.00	1.27	1.27	

Stryker®Blade is a trademark of Stryker

Grey shaded blades indicate coating.

All products may not be available in all markets.

# Stryker® Replacement Blades

Indication for Use: Total Knee Arthroplasty

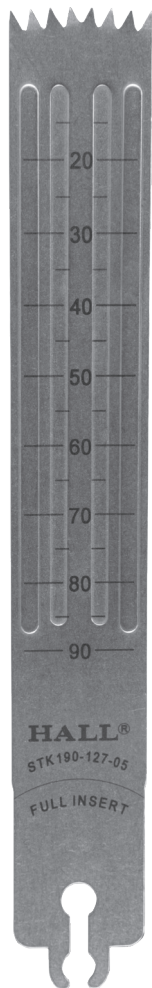

STK190-127-05

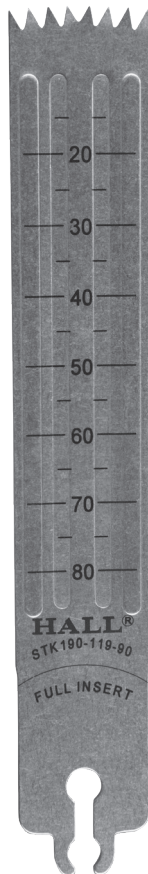

STK190-119-90

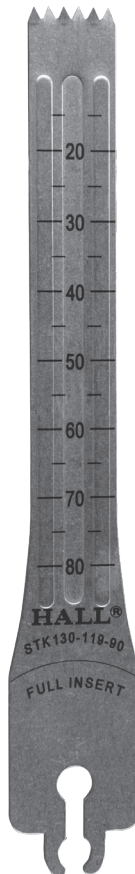

STK130-119-90

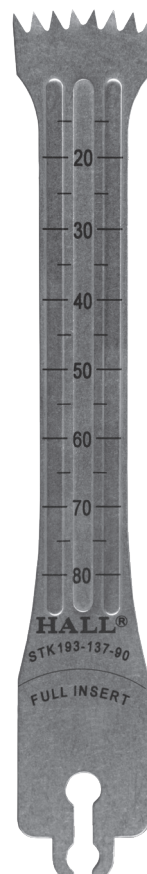

STK193-137-90

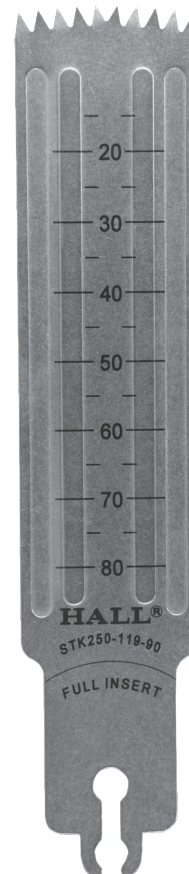

STK250-119-90

Blade images are 1:1 in length and width.

Body Width	19.0mm	19.0mm	13.0mm	19.0/13.0mm	25.0mm
Length	105.0mm	90.0mm	90.0mm	90.0mm	90.0mm
Thickness	Blade Catalog #				
0.89mm		STK190-089-90	STK130-089-90		STK193-137-90
1.00mm					STK250-100-90
1.07mm					
1.19mm		STK190-119-90	STK130-119-90		STK250-119-90
1.27mm	STK190-127-05	STK190-127-90	STK130-127-90		STK250-127-90
1.37mm		STK190-137-90		STK193-137-90	STK250-137-90
1.47mm					STK250-147-90

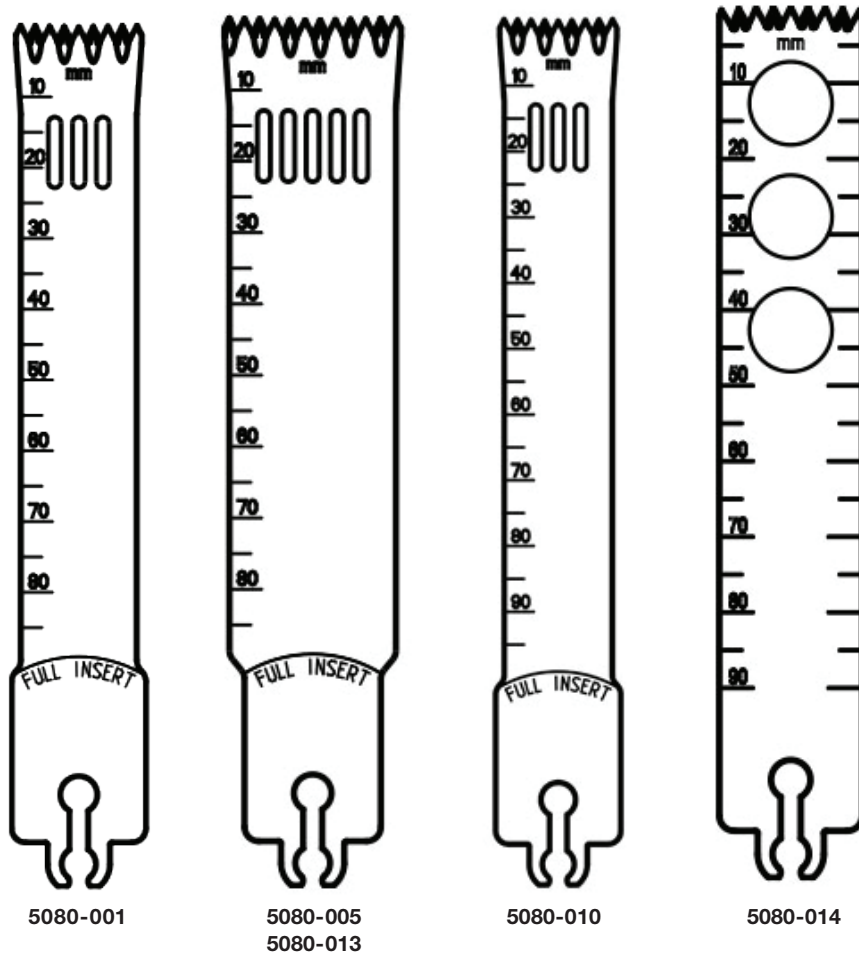

Blade images are 1:1 in length and width.

### Oscillating Large Bone





Body Width	18.0mm	25.0mm	18.0mm	19.0mm	25.4.0mm
Length	90.0mm	90.0mm	100.0mm	83.5mm	75.0mm
Thickness	Blade Catalog #				
1.27mm	5080-001	5080-005	5080-010		
1.19mm		5080-013			
1.25mm				5080-014	
0.89mm					5080-015

# Large Bone Oscillating Blades

ACL Blades



## Graft Harvesting Blades

Graft Harvesting Blades					
Cat. No.	Depth Stop (mm)	Width (mm)	Material Thickness (mm)	Cut Thickness (mm)	
5071-106	20.00	16.50	0.40	6.00	
5071-107	20.00	16.50	0.40	7.00	
5071-108	20.00	16.50	0.40	8.00	
5071-109	20.00	16.50	0.40	9.00	
5071-110	20.00	16.50	0.40	10.00	
5071-111	20.00	16.50	0.40	11.00	

## ACL Blades

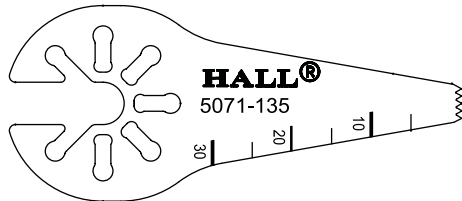
Thickness: 0.84mm					
Cat. No.	Width (mm)	Length (mm)	Material Thickness (mm)	Cut Thickness (mm)	
5071-571	9.50	30.00	0.64	0.84	
Thickness: 1.10mm					
5071-135	5.00	30.00	0.60	1.10	

All products may not be available in all markets.

## ACL Blades

Thickness: 0.60mm					
Cat. No.	Width (mm)	Length (mm)	Material Thickness (mm)	Cut Thickness (mm)	
5071-133	9.50	25.50	0.40	0.60	
5071-134	9.00	41.00	0.40	0.60	
Thickness: 0.64mm					
5071-236	9.12	25.22	0.64	0.64	
Thickness: 0.80mm					
5071-127	8.50	38.00	0.40	0.80	
5071-246	5.50	25.50	0.60	0.80	

All products may not be available in all markets.

# Large Bone Oscillating Blades

Indications for Use: Total Hip Arthroplasty  
& Large Bone Trauma



## Oscillating Blades

Thickness: 0.80mm					
Cat. No.	Width (mm)	Length (mm)	Material Thickness (mm)	Cut Thickness (mm)	
5071-132	19.50	41.00	0.40	0.80	
Thickness: 0.90mm					
5071-553	19.50	63.00	0.60	0.90	
5071-551	32.50	63.00	0.60	0.90	
5071-550	49.00	63.00	0.60	0.90	
5071-552	13.50	64.00	0.60	0.90	
5071-166	32.00	64.00	0.80	0.90	

All products may not be available in all markets.

Grey shaded blades indicate coating.

## Oscillating Blades

					Thickness: 0.90mm
Cat. No.	Width (mm)	Length (mm)	Material Thickness (mm)	Cut Thickness (mm)	
5071-186	32.00	64.00	0.80	0.90	
5071-556	33.50	64.00	0.80	0.90	
5071-177	19.50	71.00	0.80	0.90	
5071-187	19.50	71.00	0.80	0.90	
5071-572	19.50	71.00	0.80	0.90	
5071-178	19.50	80.00	0.80	0.90	
5071-188	19.50	80.00	0.80	0.90	

Grey shaded blades indicate coating.

All products may not be available in all markets.

# Large Bone Oscillating Blades

Indications for Use: Total Hip Arthroplasty  
& Large Bone Trauma



## Oscillating Blades

Thickness: 0.90mm					
Cat. No.	Width (mm)	Length (mm)	Material Thickness (mm)	Cut Thickness (mm)	
5071-174	19.50	86.00	0.80	0.90	
5071-143	25.40	90.00	0.80	0.90	
Thickness: 1.06mm					
5071-557	12.50	73.80	0.63	1.06	
Thickness: 1.40mm					
5071-554	19.50	71.00	1.20	1.40	
5071-141	19.50	80.00	1.20	1.40	



## Oscillating Blades

Thickness: 1.40mm					
Cat. No.	Width (mm)	Length (mm)	Material Thickness (mm)	Cut Thickness (mm)	
5071-140	25.40	80.00	1.20	1.40	
5071-142	25.40	90.00	1.20	1.40	
Thickness: 1.50mm					
5071-555	33.00	71.00	1.20	1.50	
5071-145	13.00	72.00	1.20	1.50	

## Oscillating Abrader

Cat. No.	Width (mm)	Length (mm)	
5071-175	20.00	45.70	

Grey shaded blades indicate coating.

All products may not be available in all markets.

# Large Bone Reciprocating Blades

Indications for Use: Total Hip Arthroplasty  
& Large Bone Trauma



## Hall® Reciprocating Blades

Thickness: 0.60mm					
Cat. No.	Width (mm)	Length (mm)	Material Thickness (mm)	Cut Thickness (mm)	
5052-260	12.50	38.00	0.40	0.60	
Thickness: 0.90mm					
5052-179	12.50	76.00	0.90	0.90	
Thickness: 1.00mm					
5052-259	9.40	54.50	0.60	1.00	
5052-173	12.50	73.50	0.80	1.00	
5052-258	12.50	89.00	0.60	1.00	
Thickness: 1.27mm					
5052-291	12.50	76.00	1.27	1.27	
Thickness: 1.50mm					
5052-276	13.00	48.00	1.50	1.50	
5052-281	9.40	54.50	1.50	1.50	
Thickness: 1.60mm					
5052-261	12.50	89.00	1.50	1.60	

All products may not be available in all markets.

Grey shaded blades indicate coating.

## Stryker® Reciprocating Blades

Cat. No.	Width (mm)	Length (mm)	Material Thickness (mm)	Cut Thickness (mm)	
5052-334	12.50	73.50	0.60	0.60	
5052-332	12.00	76.00	0.80	0.80	
5052-135	12.50	76.00	0.90	0.90	
5052-333	12.00	76.00	1.30	1.30	
5080-003	12.50	70.00	0.60		
5080-004	12.50	70.00	0.08		
5080-012	11.20	77.50	0.08		
5080-017	12.50	70.00	1.00		

Stryker® Blade is a trademark of Stryker  
Grey shaded blades indicate coating.

All products may not be available in all markets.

# Hall® MicroFree™ Power System

Indications for Use: Small Joint



**PRO8000SB**



**PRO8100SB**



**PRO8200SB**



**PRO8300SB**



**PRO8400SB**

## Hall® MicroFree™ Handpieces

**Cat. No.**

Hall® MicroFree™ High Speed Drill .....	PRO8000SB
Hall® MicroFree™ Medium Speed Drill.....	PRO8100SB
Hall® MicroFree™ Sagittal Saw .....	PRO8200SB
Hall® MicroFree™ Oscillating Saw.....	PRO8300SB
Hall® MicroFree™ Reciprocating Saw.....	PRO8400SB

### Hall® MicroFree™ Lithium Power Unit

Cat No.

Hall® MicroFree™ Lithium Power Unit.....L3500SB

### Hall® MicroFree™ Adapter and Charger

Hall® Large Lithium Battery .....L3000LG

Hall® Small Lithium Battery.....L3000SM

Hall® MicroFree™ Power Unit Adapter.....L3500

Hall® Lithium Charger.....L3000

### Hall® MicroFree™ Mini-Driver

Hall® MicroFree™ Mini-Driver .....PR08500SB



**L3500SB**



**L3000SM**



**L3000LG**



**L3500**



**L3000**



**PR08500SB**

All products may not be available in all markets.



**PRO7000DE**



**PRO7000SE**



**PRO7100SE**



**PRO7200SE**

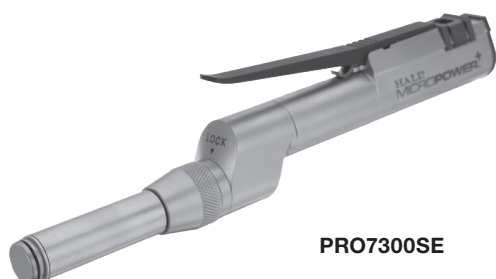

**PRO7300SE**



**PRO7400SE**

Attachments on page 49

Handpieces	
	Removable Lever
Oral Max Elite High Speed Drill	PRO7000DE
Orthopedic High Speed Drill	PRO7000SE
Medium Speed Drill	PRO7100SE
Sagittal Saw	PRO7200SE
Reciprocating Saw	PRO7300SE
Oscillating Saw	PRO7400SE



6020-025



6020-026



6020-021



6020-022



6020-023

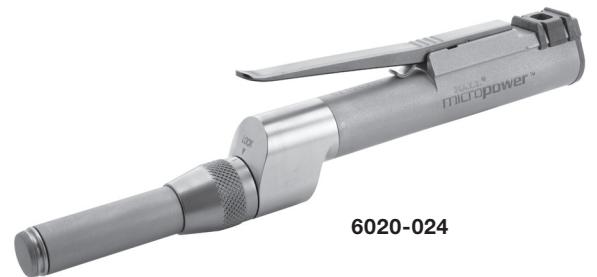

6020-024

Attachments on page 49

Handpieces	Lever Type	
	Removable Lever	Permanently Attached Lever
Oral Max High Speed Drill	6020-025	6021-025
Orthopedic High Speed Drill	6020-026	6021-026
Medium Speed Drill	6020-021	6021-021
Sagittal Saw	6020-022	6021-022
Reciprocating Saw	6020-023	6021-023
Oscillating Saw	6020-024	6021-024

All products may not be available in all markets.

# Micro 100™

Indications for Use: Small Bone

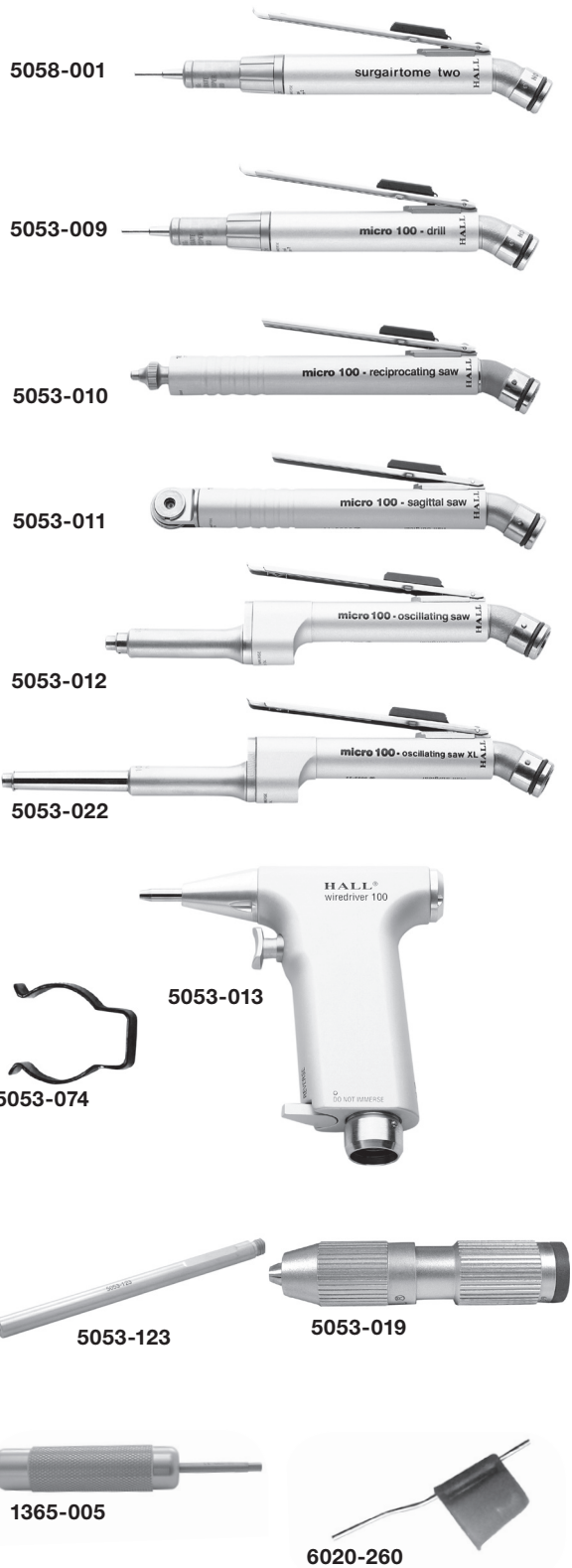

## Handpieces

Cat. No.

Surgairtome Two® High Speed Drill Kit (System listing on page 83) .....	5058-000
Surgairtome Two High Speed Drill .....	5058-001
Medium Speed Drill .....	5053-009
Reciprocating Saw .....	5053-010
Sagittal Saw .....	5053-011
Oscillating Saw .....	5053-012
Wire Driver .....	5053-013
Throttle Clip (for lever) Used during footswitch operation .....	5053-074

## Attachments & Accessories

Wire Guard for use with 5053-013 .....	5053-123
Wire Driver Adapter Chuck for use with 5053-013 .....	5053-019
Replacement Hex Wrench for Micro 100™ Sagittal & Oscillating Saw .....	1365-005
Burguard Sleeve Surgairtome Two .....	1375-112
Smartguard Irrigator .....	6020-260

Attachments on Page 49



## Attachments

	Cat. No.
Medium Precision Bur Guard.....	1375-012P
Long Precision Bur Guard.....	1375-011P
X-Long Precision Bur Guard.....	1375-023P
Medium Bur Guard.....	1375-012
Long Bur Guard.....	1375-011
X-Long Bur Guard.....	1375-023
Irrigation Tubing Set.....	E9418

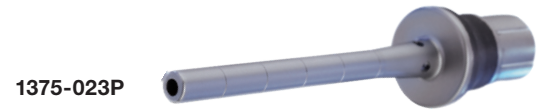

All products may not be available in all markets.

# Sterilization Trays

For Use with Micro Handpieces



**PRO7003T**

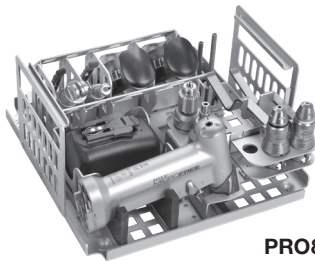

**PRO8001T**



**TR12R with PRO8003T**

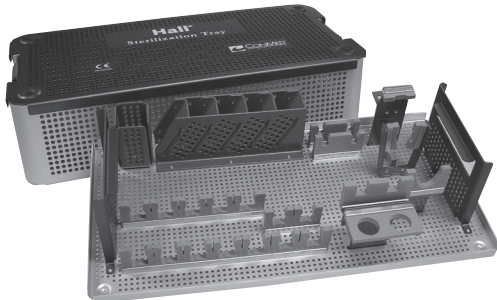

**PRO6000**

## Hall® Sterilization Containers/Inner Trays

Cat. No.

½ Size Rigid Sterilization Container .....TR12R

## Sterilization Inner Trays





½ Size Inner Tray, Small Bone Set..... PRO7003T

½ Size Inner Tray, Drill Set.....PRO8003T

½ Size Inner Tray, Drill Set with Mini Driver ..... PRO8001T

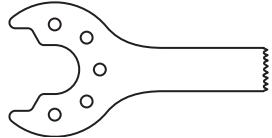
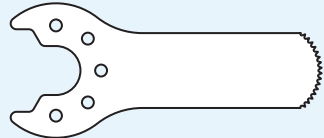
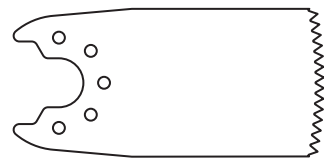
Small Bone Tray .....PRO6000

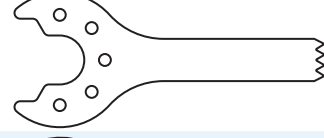
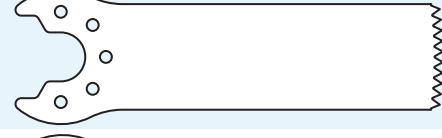
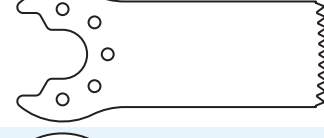
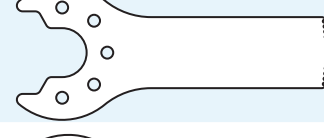
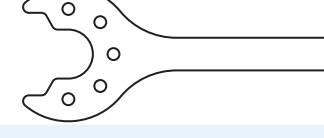
## Sagittal Saw Blades

Thickness: 0.60mm						
Cat. No.	Tooth	Width (mm)	Length (mm)	Material Thickness (mm)	Cut Thickness (mm)	
5023-144	Fine	5.50	18.50	0.40	0.60	
5023-118	Fine	9.50	25.50	0.40	0.60	
5023-130	Coarse	19.50	25.50	0.40	0.60	
5023-131	Coarse	19.50	41.00	0.40	0.60	
5023-132	Coarse	5.50	25.50	0.40	0.60	
5023-133	Coarse	14.00	41.00	0.40	0.60	
5023-137	Coarse	14.00	25.50	0.40	0.60	
5023-138	Fine	9.50	25.50	0.40	0.60	
5023-139	Fine	4.50	25.50	0.40	0.60	
5023-140	Tapered/Fine	9.50	41.00	0.40	0.60	

All products may not be available in all markets.

# Micro Sagittal Saw Blades



## Sagittal Saw Blades

Thickness: 0.60mm						
Cat. No.	Tooth	Width (mm)	Length (mm)	Material Thickness (mm)	Cut Thickness (mm)	
5023-141	Fine	6.00	34.00	0.40	0.60	
5023-142	Fine	4.00	34.00	0.40	0.60	
5023-143	Coarse	9.50	25.50	0.40	0.60	
5023-244	Fine	4.00	6.00	0.40	0.60	
5044-145	Fine	10.00	18.50	0.40	0.60	
5023-247	Fine	9.50	25.50	0.60	0.60	
5023-249	Fine	9.00	31.00	0.40	0.60	

All products may not be available in all markets.

## Stryker® Hub Sagittal Saw Blades

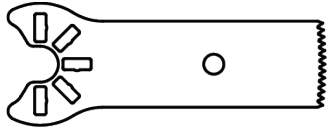
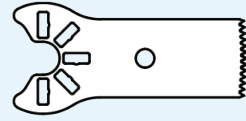
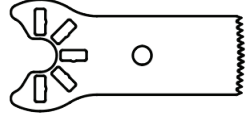
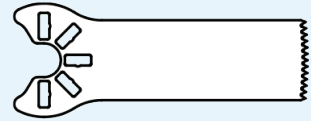
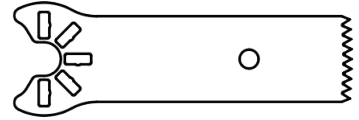
Thickness: 0.60mm						
Cat. No.	Tooth	Width (mm)	Length (mm)	Material Thickness (mm)	Cut Thickness (mm)	
5080-002	?	9.80	25.0	0.40	?	
5080-008	?	5.50	18.0	0.40	?	
5080-009	?	9.80	18.0	0.40	?	
5080-011	?	9.50	25.0	0.50	?	
5080-016	?	9.50	31.0	0.40	?	

All products may not be available in all markets.

## Angled Sagittal Saw Blades

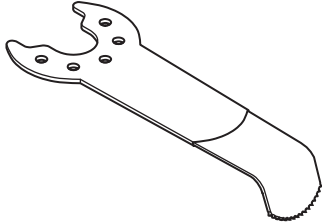
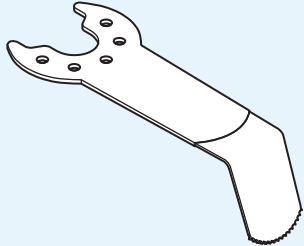
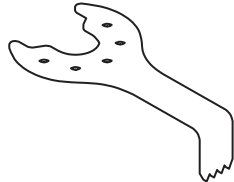
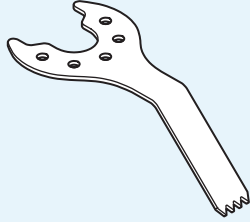
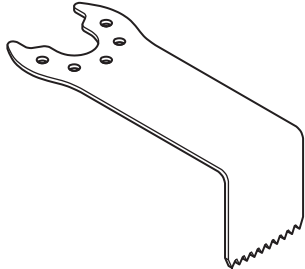
Thickness: 0.60mm							
Cat. No.	Tooth	Angle	Width (mm)	Length (mm)	Material Thickness (mm)	Cut Thickness (mm)	
5023-128	Fine	70 Degree	9.50	7.50	0.40	0.60	
5023-129	Fine	70 Degree	9.50	13.50	0.40	0.60	
5023-134	Coarse	90 Degree	5.50	9.00	0.40	0.60	
5023-135	Coarse	45 Degree	5.50	18.00	0.40	0.60	
5023-136	Coarse	90 Degree	14.00	15.50	0.40	0.60	

## ACL Blades

Thickness: 0.60mm								
Cat. No.	Tooth	Edge	Depth Stop (mm)	Width (mm)	Length (mm)	Material Thickness (mm)	Cut Thickness (mm)	
C8803	Fine	Straight	8.0 with guide/ 12 without guide	9.40	41.00	0.38	0.60	
C8804	Fine	Straight	8.0 Freehand	9.40	41.00	0.38	0.60	
C8806	Fine	Straight	10.0 Freehand	9.40	41.00	0.38	0.60	
8703	Fine	Straight	8.0 with guide/ 12 without guide	9.50	25.50	0.40	0.60	
5023-183	Fine	Straight	None	9.50	25.50	0.40	0.60	
5023-184	Tapered/Fine	Straight	None	9.50	41.00	0.40	0.60	
5023-185	Tapered/Coarse	Straight	None	6.50	30.00	0.40	0.60	
Thickness: 0.69mm								
5023-182	Coarse	Straight	None	19.00	41.00	0.40	0.69	
Thickness: 0.74mm								
5023-186	Coarse	Straight	None	8.50	38.00	0.40	0.74	

All products may not be available in all markets.

## Dermabraders

Thickness: 3.80mm						
Cat. No.	Tooth	Edge	Width (mm)	Length (mm)	Material Thickness (mm)	
5023-055	Abrader	Straight	25.00	6.30	3.80	
5023-056	Abrader	25 Degree	25.00	6.30	3.80	

## Graft Harvesting Blades

Cat. No.	Depth Stop (mm)	Width (mm)	Material Thickness (mm)	Cut Thickness (mm)	
5023-405	20.00	16.50	0.40	5.00	
5023-406	20.00	16.50	0.40	6.00	
5023-407	20.00	16.50	0.40	7.00	
5023-408	20.00	16.50	0.40	8.00	
5023-409	20.00	16.50	0.40	9.00	
5023-411	20.00	16.50	0.40	11.00	
5023-412	20.00	16.50	0.40	12.00	



## Oscillating Saw Blades

Thickness: 0.60mm							
Cat. No.	Tooth	Edge	Width (mm)	Length (mm)	Material Thickness (mm)	Cut Thickness (mm)	
5023-160	Fine	Straight	5.50	12.00	0.40	0.60	
5023-161	Fine	Straight	10.00	12.00	0.40	0.60	
5023-162	Fine	Straight	5.50	18.50	0.40	0.60	
5023-163	Fine	Straight	10.00	18.50	0.40	0.60	
5023-164	Fine	Straight	5.50	28.50	0.40	0.60	
5023-165	Fine	Radial	10.00	28.50	0.40	0.60	
5023-166	Fine	Radial	18.50	28.50	0.40	0.60	
5023-169	Fine	Straight	10.00	35.00	0.40	0.60	

## Angled Oscillating Saw Blades

Thickness: 0.60mm							
Cat. No.	Tooth	Edge	Width (mm)	Length (mm)	Material Thickness (mm)	Cut Thickness (mm)	
5023-258	Fine	Radial/20 Degree	10.00	9.00	0.40	0.60	
5023-259	Fine	Radial/20 Degree	10.00	13.50	0.40	0.60	
5023-167	Fine	20 Degree	5.50	13.00	0.40	0.60	
5023-168	Fine	Radial/20 Degree	10.00	13.00	0.40	0.60	

All products may not be available in all markets.

# Micro Oscillating Saw Blades

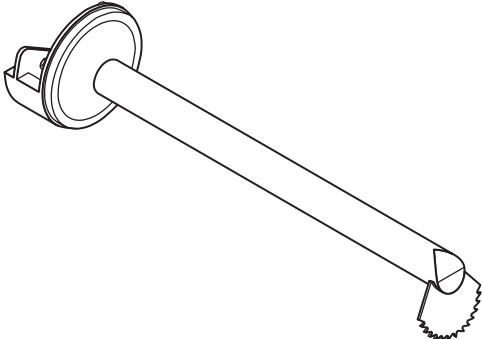
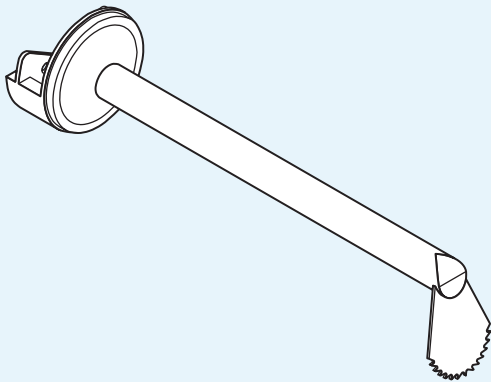
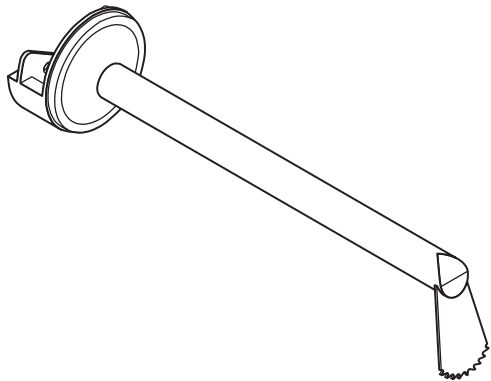
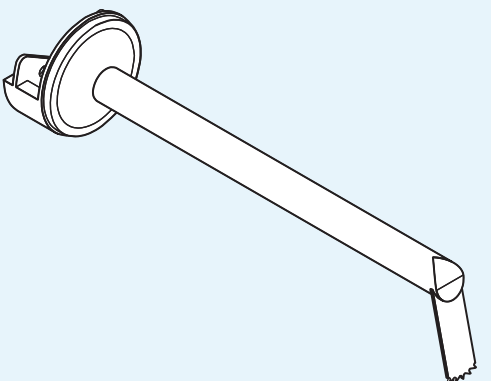

## Intra-Oral Blades \*Not for use with Micro 100™

Thickness: 0.60mm							
Cat. No.	Tooth	Width (mm)	Length (mm)	Material Thickness (mm)	Cut Thickness (mm)	Cutting Depth (mm)	
5023-101*	Coarse	11.50	7.00	0.40	0.60	7.00	
5023-102*	Coarse	11.50	12.00	0.40	0.60	12.00	
5023-103*	Coarse	9.00	12.00	0.40	0.60	12.0	
5023-104*	Coarse	5.00	12.00	0.40	0.60	12.00	

All products may not be available in all markets.

## Crescentic Blades

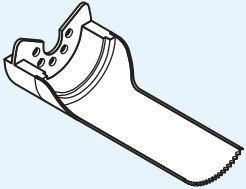
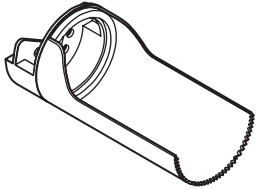
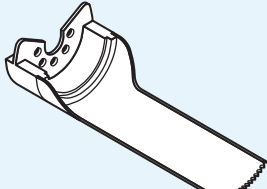
Thickness: 0.60mm							
Cat. No.	Tooth	Width (mm)	Length (mm)	Material Thickness (mm)	Cut Thickness (mm)	Cutting Depth (mm)	
5023-170	Fine	9.0	12.00	0.40	0.60	12.00	
5023-171	Fine	13.5	25.50	0.40	0.60	25.50	
5023-172	Fine	18.0	32.00	0.40	0.60	32.00	
5023-176	Fine	13.5	32.00	0.40	0.60	32.00	

All products may not be available in all markets.

# Micro Reciprocating Saw Blades & Rasps



## Reciprocating Rasp

Cat. No.	Shank	Width (mm)	Length (mm)	
5053-080	Round	5.50	9.50	
5053-082	Round	5.50	9.50	
5053-081	Round	6.50	12.50	
5053-083	Round	6.50	12.50	
5053-084	Round	5.30	24.50	
5053-085	Round	9.50	30.50	
5080-007**	Round	5.50	73.00	

\*\*Stryker Rasp Replacement

## Reciprocating Saw Blades

Cat. No.	Shank	Length (mm)	Material Thickness (mm)	
5053-122	Flat	25.50	0.25	
5053-220	Flat	25.50	0.40	
5053-221	Flat	38.00	0.40	
5053-054	Round	25.00	0.60	
5053-126	Round	28.00	0.60	

## Depth Limiting Reciprocating Saw Blades

Thickness: 4.00mm					
Cat. No.	Shank	Length (mm)	Material Thickness (mm)	Cut Depth (mm)	
5053-051	Round	17.00	0.60	4.00	
Thickness: 5.00mm					
5053-050	Round	7.00	0.60	5.00	
5053-052	Round	23.00	0.60	5.00	
Thickness: 7.00mm					
5053-053	Round	25.00	0.60	7.00	

All products may not be available in all markets.

	Round Fluted												
	Flutes (mm)	4.00	6.00	6.00	8.00	6.00	8.00	6.00	8.00	8.00	10.00	10.00	10.00
MicroPower & Micro 100 Bur Guards	Diameter (mm)	0.50	1.00	1.50	1.80	2.00	2.30	2.40	3.00	4.00	5.00	6.00	6.50
1375-012				5091-222	5091-221	5091-224	5091-223	5091-225	5091-226	5091-228	5091-230	M60R	5091-232
1375-011			5092-220	5092-222	L18R	5092-224	L23R		5092-226	5092-228	5092-230	L60R	5092-232
1375-023			5093-220			5093-224			5093-226	5093-228	5093-230	X60R	5093-232

	Fine Round Diamond						
MicroPower & Micro 100 Bur Guards	Diameter (mm)	1.00	2.00	3.00	4.00	5.00	6.00
1375-012			5091-260		5091-264		5091-268
1375-011		L10D	5092-260	5092-262	5092-264	5092-266	5092-268
1375-023		X10D	5093-260	5093-262	5093-264	5093-266	

	Wire Pass Burs			
	Flutes (mm)	2.00	2.00	2.00
	Diameter (mm)	1.00	1.50	2.00
MicroPower & Micro 100 Bur Guards	Length (mm)	19.00	19.00	19.00
		5090-247	5090-248	5090-249
		5090-247	5090-248	5090-249
1375-011		5092-247		
		5092-247		
1375-012		5091-247	5091-248	5091-249

	Swanson Reamers				
	Flutes (mm)	4.00	6.00	6.00	8.00
MicroPower & Micro 100 Bur Guards	Diameter (mm)	2.00	3.00	4.00	5.00
1375-012		5091-242	5091-243	5091-244	5091-245

	Dermabraders – Fine Diamond					N/A	N/A	N/A	N/A	
	Diameter (mm)	2.00	4.00	6.00	4.00	4.00	7.00	12.00	10.00	2.00
MicroPower & Micro 100 Bur Guards	Bur Head Length (mm)				8.00	15.00	15.00	15.00	15.00	19.00
1375-012		5091-260	5091-264	5091-268	5091-270		5091-081	5091-082	5091-083	
1375-011					5092-270					

Bur Shank Diameter 2.34mm (0.82")

# Micro Burs



	<b>Straight Side Cutting Burs</b>														
	<b>Flutes (mm)</b>	6.00	6.00	6.00	6.00	6.00	6.00	6.00	6.00	6.00	6.00	6.00	6.00	6.00	
	<b>Diameter (mm)</b>	1.00	1.10	1.20	1.30	1.30	1.50	1.50	1.50	1.60	1.60	1.70	1.70	1.70	
	<b>MicroPower &amp; Micro 100 Bur Guards</b>	<b>Bur Head Length (mm)</b>	5.00	5.00	4.90	9.90	9.90	5.10	8.00	10.00	4.30	7.50	12.00	9.90	9.90
1375-012		5091-201	M10S	5091-216		M13S	5091-204		5091-202	5091-217	M15S			M17S	
1375-011					L13S		5092-204					5092-203	L17S		

	<b>Tapered Side-cutting</b>							
	<b>Diameter (mm)</b>	0.80	1.20	1.20	1.20	1.60	1.60	
	<b>MicroPower &amp; Micro 100 Bur Guards</b>	<b>Bur Head Length (mm)</b>	4.90	9.90	3.70	9.90	21.60	4.30
1375-012		5091-215	M12T	5091-219		M20T	5091-218	
1375-011					L12T			

	<b>Tapered Side-cutting</b>						
	<b>Diameter (mm)</b>	1.60	2.00	2.00	2.00	2.00	
	<b>MicroPower &amp; Micro 100 Bur Guards</b>	<b>Bur Head Length (mm)</b>	21.90	7.50	19.00	7.50	19.00
1375-012				5091-206	5091-214		
1375-011			L20T			5092-206	5092-214



	<b>Barrel Burs</b>			
	<b>Flutes (mm)</b>	6.00	6.00	
	<b>Diameter (mm)</b>	2.00	4.00	
	<b>MicroPower &amp; Micro 100 Bur Guards</b>	<b>Bur Head Length (mm)</b>	10.00	10.00
1375-012		5091-252	5091-254	
1375-011		5092-252	5092-254	



	<b>Oval Burs</b>					
	<b>Flutes (mm)</b>	8.00	8.00	8.00	8.00	
	<b>Diameter (mm)</b>	4.00	5.50	4.00	5.50	
	<b>MicroPower &amp; Micro 100 Bur Guards</b>	<b>Bur Head Length (mm)</b>	8.00	10.0	7.9	10.0
1375-012		5091-236	5091-238	M40B	M55B	
1375-011		5092-236	5092-238	L40B	L55B	
1375-023			5093-238	X40B		



All products may not be available in all markets.

	<b>Lindemann Burs</b>	
	Flutes (mm)	4.00
	Diameter (mm)	1.60
<b>MicroPower &amp; Micro 100 Bur Guards</b>	Bur Head Length (mm)	31.00
1375-012		5091-212

	<b>Cylindrical</b>	
	Flutes (mm)	2.00
	Diameter (mm)	3.00
<b>MicroPower &amp; Micro 100 Bur Guards</b>	Bur Head Length (mm)	4.00
1375-011		5092-291

	<b>Cone Burs</b>		
	Flutes (mm)	8.00	12.00
	Diameter (mm)	4.50	4.50
<b>MicroPower &amp; Micro 100 Bur Guards</b>	Bur Head Length (mm)	12.00	12.00
1375-012		M45C	
1375-011			L45C

	<b>Tapered Cross-cut Fissure Burs</b>			
	Flutes (mm)	701 Type	702 Type	703 Type
	Diameter (mm)	1.20	1.60	2.10
<b>MicroPower &amp; Micro 100 Bur Guards</b>	Bur Head Length (mm)	2.30	3.80	4.90
1375-012		5091-271	5091-272	5091-213
1375-011		5092-271	5092-272	5092-273

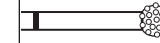
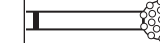
	<b>Heavy Grit Diamond-Microbur. X-Long</b>					
<b>MicroPower &amp; Micro 100 bur guards</b>	Diameter (mm)	2.00	3.00	4.00	5.00	6.00
	Grit	60-70	60-70	40-45	40-45	40-45
1375-023		5093-282	5093-283	5093-284	5093-285	
1375-011			5092-283	5092-284	5092-285	

All products may not be available in all markets.



**PRO7450B**



**PRO6450M**



**5059-005**



**5059-007**



**5059-006**



**5059-011**



	<b>Cat. No.</b>
Hall 50™ Sternum Saw Handpiece.....	PRO7450B
MPOWER 2 Battery Sternum Saw.....	PRO6450M

See pages 8, and 9 for battery accessories.  
Saw does not include sternum guard or blade.

Pneumatic Sternum Saw.....	5059-005
----------------------------	----------

Sternum Saw Wrench, for PRO7450B, PRO6450, PRO6450M & 5059-005.....	5059-007
---	----------

Sternum Guard, 2.25" (5.72mm), for PRO7450B, PRO6450, PRO6450M & 5059-005.....	5059-006
--	----------

Sternum Guard, 3.12" (7.92mm), for PRO7450B, PRO6450, PRO6450M & 5059-005.....	5059-011
--	----------

Repeat Sternotomy Saw, Pneumatic.....	5057-040
---------------------------------------	----------

All products may not be available in all markets.



## Sternum Saw Blades

Cat. No.	Width (mm)	Length (mm)	Non-sterile	
5059-235**		32.00		
5080-006**	0.80	31.00		
5059-532	10.00	35.00		
5059-032-01	10.00	35.00	50 Pack	
5059-531	10.00	54.00		
5059-031	10.00	54.00		
5059-031-01	10.00	54.00	50 Pack	

\*\* For use with Stryker® Sternum Saw

## Repeat Sternotomy Blades

Cat. No.	Width (mm)	Length (mm)		Cat. No.	Width (mm)	Length (mm)	
1384-175	52.00	19.00		5023-187	50.00	24.00	
1384-176	63.00	19.00		5023-188	63.00	24.00	

All products may not be available in all markets.

# Sternum Saw Blades

Indications for Use: Primary & Repeat Sternotomy



## Repeat Sternotomy Blades

Cat. No.	Width (mm)	Length (mm)	
5023-178	44.60	40.00	
5023-179	54.60	40.00	
5023-180	65.80	40.00	

Cat. No.	Width (mm)	Length (mm)	
5059-278	44.60	40.00	
5059-279	54.60	40.00	
5059-280	65.80	40.00	

All products may not be available in all markets.

## Repeat Sternotomy Blades

Cat. No.	Width (mm)	Length (mm)		Cat. No.	Width (mm)	Length (mm)	
5071-125	50.00	19.00		5071-229	54.50	40.00	
5071-126	63.00	19.00		5071-230	66.00	40.00	
5071-228	44.50	40.00					

All products may not be available in all markets.



7020-001



7020-003



7020-045



7020-016



7020-015



7020-014



7020-013



7020-019



7020-017



7020-018



7020-012



7020-011



7020-010

## Handpieces

Cat. No.

Ultrapower High Speed Drill ..... 7020-001

Ultrapower Perforator Drive ..... 7020-003

## Attachments & Accessories

Ultrapower Footswitch ..... 7020-045

Short Bur Guard (like Midas-X) Red ..... 7020-010

Medium Bur Guard (like Midas-O) Copper ..... 7020-011

Long Bur Guard (like Midas-M/B) Mustard ..... 7020-012

X-Long Bur Guard (like Midas-AM/A) Lime ..... 7020-013









Short Revision Extension (like Midas TU) Teal ..... 7020-014





Medium Revision Extension (like Midas-R) Purple ..... 7020-015







Short Bur Guard (like Midas B-5) Black ..... 7020-017

Medium Bur Guard (like Midas B-1) Green ..... 7020-018

Long Bur Guard (like Midas S-1) Brown ..... 7020-019

	Round Fluted									
	Flutes (mm)	4.00	6.00	6.00	6.00	8.00	8.00	8.00	8.00	8.00
UltraPower Bur Guard No.	Diameter (mm)	0.50	1.00	1.50	2.00	2.50	3.00	4.00	5.00	6.00
7020-010								7021-027	7021-028	7021-029
7020-011				7021-123	7021-124	7021-125	7021-126	7021-127	7021-128	7021-129
7020-012		7021-220	7021-222	7021-223	7021-224	7021-225	7021-226	7021-227	7021-228	7021-229
7020-013			7021-322	7021-323	7021-324	7021-325	7021-326	7021-327	7021-328	7021-329
7020-014							7021-426		7021-428	7021-429
7020-015									7021-528	7021-529







	Round Fluted					
	Flutes (mm)	10	10	10	10	10
UltraPower Bur Guard No.	Diameter (mm)	6.5	7.5	8.0	9.0	10.0
7020-010		7021-030				
7020-011		7021-130	7021-131	7021-134	7021-132	7021-133
7020-012		7021-230	7021-231		7021-232	7021-233
7020-013			7021-331		7021-332	7021-333
7020-014			7021-431		7021-432	
7020-015			7021-531		7021-532	7021-533





	Fine Round Diamond							
UltraPower Bur Guard No.	Diameter (mm)	1.0	2.0	3.0	4.0	5.0	6.0	7.0
7020-010			7021-062	7021-063	7021-064			
7020-011			7021-162	7021-163	7021-164	7021-165	7021-166	7021-167
7020-012		7021-261	7021-262	7021-263	7021-264	7021-265	7021-266	7021-267
7020-013		7021-361	7021-362	7021-363	7021-364	7021-365	7021-366	7021-367



# UltraPower® Burs









Indications for Use: Otology  
(Round Burs Only), Spine & Neuro







	Coarse Round Diamond							
UltraPower Bur Guard No.	Diameter (mm)	1.00	2.00	3.00	4.00	5.00	6.00	7.00
7020-010					7021-074	7021-075		7021-077
7020-011			7021-172	7021-173	7021-174	7021-175	7021-176	7021-177
7020-012			7021-272	7021-273	7021-274	7021-275	7021-276	7021-277
7020-013			7021-372	7021-373	7021-374	7021-375	7021-376	
7020-014					7021-474			

	Side Cutting, Burs					
	Flutes (mm)	8.00	8.00	8.00	8.00	8.00
	Diameter (mm)	5.00	5.00	7.50	7.50	7.50
UltraPower Bur Guard No.	Bur Head Length (mm)	8.00	17.00	5.00	9.00	28.00
7020-012						
7020-013			7021-303	7021-305		
7020-014						

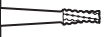
	Side Cutting Burs			
	Flutes (mm)	8.00	8.00	12.00
	Diameter (mm)	9.00	9.00	10.50
UltraPower Bur Guard No.	Bur Head Length (mm)	5.00	9.00	11.00
7020-012				
7020-013				7021-310
7020-014		7021-408		
7020-015			7021-509	

	Side Cutting Burs									
	Flutes (mm)	1.00	1.00	1.00	2.00	2.00	2.00	2.00	2.00	2.00
	Diameter (mm)	1.50	1.8	2.00	1.20	2.20	2.20	2.20	3.00	3.00
Ultrapower Bur Guard No.	Bur Head Length (mm)	8.00	11.00	16.0	6.00	16.00	23.00	20.00	25.00	
7020-010			7021-013			7021-015				
7020-011		7021-112	7021-113				7021-116			
7020-012			7021-713	7021-214	7021-243	7021-815				7021-917
7020-013				7021-314		7021-315				



	Side Cutting Burs		
	Flutes (mm)	2.00	6.00
	Diameter (mm)	3.00	1.50
Ultrapower Bur Guard No.	Bur Head Length (mm)	36.00	4.90
7020-011			7021-119
7020-012		7021-218	
7020-013		7021-318	





	Fluted Cylindrical Burs				
	Flutes (mm)	2.00	2.00	2.00	2.00
Ultrapower Bur Guard No.	Diameter (mm)	1.80	1.80	2.20	3.00
7020-010					
7020-011				7021-136	7021-137
7020-012				7021-236	7021-237
7020-013			7021-335	7021-336	7021-337
7020-014					7021-437





# UltraPower® Burs

Indications for Use: Otology  
(Round Burs Only), Spine & Neuro



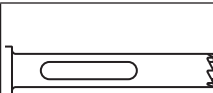

		Fine Diamond Cylindrical Burs	
			
Ultrapower Bur Guard No.	Diameter (mm)	1.90	3.00
7020-012			7021-279
7020-013		7021-378	7021-379

		Fluted Acorn Burs				
						
		Flutes (mm)	8.00	8.00	8.00	8.00
Ultrapower Bur Guard No.	Diameter (mm)	5.00	6.00	7.50	9.00	
7020-010				7021-081		7021-083
7020-011				7021-181	7021-182	7021-183
7020-012			7021-280	7021-281	7021-282	7021-283
7020-013			7021-380	7021-381	7021-382	7021-383
7020-014					7021-482	7021-483
7020-015				7021-581		7021-583
7020-016				7021-681		7021-683

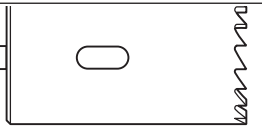
		Trepine Burs			
					
Ultrapower Bur Guard No.	Diameter (mm)	3.20	5.30	10.70	13.50
7020-010			7021-051		
7020-012		7021-250		7021-252	7021-253

		Trepine Burs
		
Ultrapower Bur Guard No.	Diameter (mm)	16.80
7020-012		7021-255





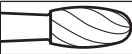
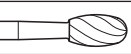

	Wire Pass Burs			
	Flutes (mm)	2.00	2.00	2.00
UltraPower Bur Guard No.	Diameter (mm)	1.00	1.50	2.00
7020-010		7021-040	7021-041	7021-042
7020-011		7021-140	7021-141	7021-142

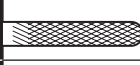
	Oval Fluted Burs		
	Flutes (mm)	8.00	8.00
	Diameter (mm)	4.00	5.50
UltraPower Bur Guard No.	Bur Head Length (mm)	8.00	10.00
7020-010		7021-095	7021-096
7020-011		7021-195	7021-196
7020-012		7021-295	7021-296
7020-013		7021-395	7021-396

	Fluted Frustrum Bur	
	Flutes (mm)	8.00
UltraPower Bur Guard No.	Diameter (mm)	6.50
7020-013		7021-391

	Carbide Metal Cutting Burs	
	Diameter (mm)	3.20
UltraPower Bur Guard No.	Bur Head Length (mm)	15.20
7020-010		7021-094
7020-012		7021-294

	Wire Pass Burs – Depth Limiting				
	Diameter (mm)	1.10	1.10	1.10	1.50
UltraPower Bur Guard No.	Depth (mm)	3.50	5.00	9.00	7.00
7020-011		7021-141-35	7021-141-50	7021-141-90	7021-145-70

	Carbide Metal Cutting Burs	
	Flutes (mm)	8.00
	Diameter (mm)	6.00
UltraPower Bur Guard No.	Bur Head Length (mm)	4.00
7020-012		7021-297

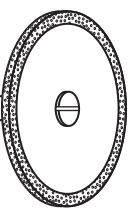
	Fine Diamond Wheels for Metal Cutting	
UltraPower Bur Guard No.	Diameter (mm)	25.40
7020-010		7021-092
7020-012		7021-292
7020-013		7021-392
7020-014		7021-492

# E9000<sup>®</sup> System

Indications for Use: ENT, Spine & Neuro

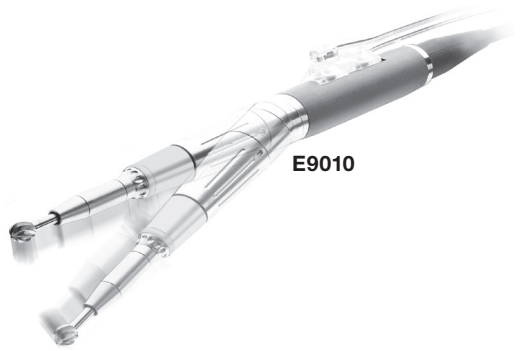

E9010



E9005



E9015



E9011-1

E9011-2



E9011-3



E9011-7



E9011-8



E9011-9



E9323



E9414

E9415A

E9416



E9315



7020-046

## Handpieces

Cat. No.

CoolFlex<sup>®</sup> High Speed Drill ..... E9010

High Speed Shaver ..... E9005

Cranial Perforator Drive..... E9015

## Attachments & Accessories

Medium Bur Guard for E9010 Drill ..... E9011-1

Long Bur Guard for E9010 Drill ..... E9011-2

X-Long Bur Guard for E9010 Drill..... E9011-3

Short Neuro Guard for E9010 Drill..... E9011-7

Medium Neuro Guard for E9010 Drill..... E9011-8

Long Neuro Guard for E9010 Drill ..... E9011-9

Bur Rack, Holds up to 20 burs for E9010 Drill ..... E9323

Drill Tubing for E9010 Drill without irrigation tip ..... E9414

Drill Tubing for E9010 Drill with irrigation tip..... E9415A

4.2mm FESS Irrigation Tubing Set for E9005 Shaver ..... E9416

3.7mm FESS Irrigation Tubing Set for E9005 Shaver (Not Shown)..... E9417

DeClogger for removing tissue and bone from shaver blades and burs ..... E9315

Bur Cabinet for Neuro Burs ..... 7020-046

**For use with:**

E9005 High Speed Shaver

**MicroXcisor® Blade**

4.2mm, Irrigated, 10.5cm Working Length, 6/Box ..... N9330

Cat. No.

**Lynx® Blade**

4.2mm, Irrigated, 10.5cm Working Length, 6/Box ..... N9150

**Rhinotec® Cuda® Blade**

- 4.2mm, Bendable to 30°, Irrigated, 10.5cm Working Length, 6/Box..... E9350
- 3.7mm, Bendable to 30°, Irrigated, 10.5cm Working Length, 6/Box.....E9351
- 4.2mm, Bendable to 45°, 10.5cm Working Length, 6/Box..... A9350
- 4.2mm, Irrigated, 10.5cm Working Length, 6/Box ..... N9210
- 3.5mm, 7.6cm Working Length, 6/Box..... C9952
- 2.9mm, 7.6cm Working Length, 6/Box..... C9951
- 2.0mm, 7.6cm Working Length, 6/Box..... C9950



Ideal for aggressive removal of ethmoid bone, cartilage and soft tissue



Ideal for aggressive removal of ethmoid bone, cartilage and soft tissue



Ideal for removal of soft tissue  
Products not shown at actual size.

All products may not be available in all markets.

# E9005 ENT Shaver Blades

Indications for Use: Sinus Surgery



Ideal for aggressive removal of soft tissue, cartilage and thin bone



Ideal for the most gentle removal of soft tissue



Ideal for removal of soft tissue in laryngeal procedures

## Rhinotec® Gator® Blade

Cat. No.

4.2mm, Bendable to 30°, Irrigated, 10.5cm Working Length, 6/Box.....	E9360
3.7mm, Bendable to 30°, Irrigated, 10.5cm Working Length, 6/Box.....	E9361
4.2mm, Bendable to 45°, 10.5cm Working Length, 6/Box.....	A9360
4.2mm, Irrigated, 10.5cm Working Length, 6/Box.....	N9220
3.5mm, 7.6cm Working Length, 6/Box.....	C9962
2.9mm, 7.6cm Working Length, 6/Box.....	C9961
2.0mm, 7.6cm Working Length, 6/Box.....	C9960

## Head & Neck Blade

4.2mm, 11.5cm Working Length, 6/Box.....	N9321
3.5mm, 7.0cm Working Length, 6/Box.....	N9320

## Laryngeal Blade

3.7mm, Bendable to 45°, 20.0cm Working Length, 6/Box.....	E9363
---	-------

## Rhinotec® Vortex® Router

	Cat. No.
3.5mm, Hooded, 7.6cm Working Length, 6/Box .....	C9991
2.9mm, Hooded, 7.6cm Working Length, 6/Box .....	C9990

## Curved Vortex Router

4.5mm, 45° Pre-Bent, 11.5cm Working Length, 6/Box.....	N9375
--	-------

## Otolaryngology Bur

4.0mm, Hooded, 10.8cm Working Length, 6/Box .....	N9390
---	-------



Ideal for aggressive removal of hard bone and cartilage



45° fixed curve (pre-bent)  
Ideal for aggressive removal of hard bone

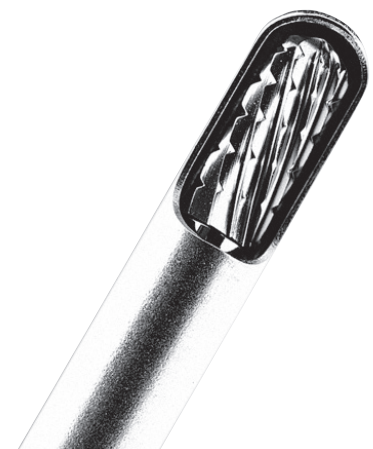

Ideal for less aggressive removal of hard bone Ideal for rhinoplasty

All products may not be available in all markets.

# E9005 ENT Shaver Blades

Indications for Use: Sinus Surgery



Ideal for aggressive removal of hard bone and cartilage



Ideal for less aggressive removal of hard bone and cartilage



Ideal for less aggressive removal of hard bone and cartilage

## Rhinotec® Spherical Bur, Hooded

Cat. No.

4.5mm, Hooded, 10.8cm Working Length, 6/Box ..... N9380

3.5mm, Hooded, 7.6cm Working Length, 6/Box ..... C9912

2.9mm, Hooded, 7.6cm Working Length, 6/ Box .....C9911

## Rhinotec® Spherical Bur, Unhooded

3.5mm, Unhooded, 7.6cm Working Length, 6/Box..... N9382

## Rhinotec Spherical Diamond Bur, Hooded

3.5mm, Hooded, 10.8cm Working Length, 6/Box ..... N9385

\*These burs may be used with multiple bur guard options to change the working length of the bur.

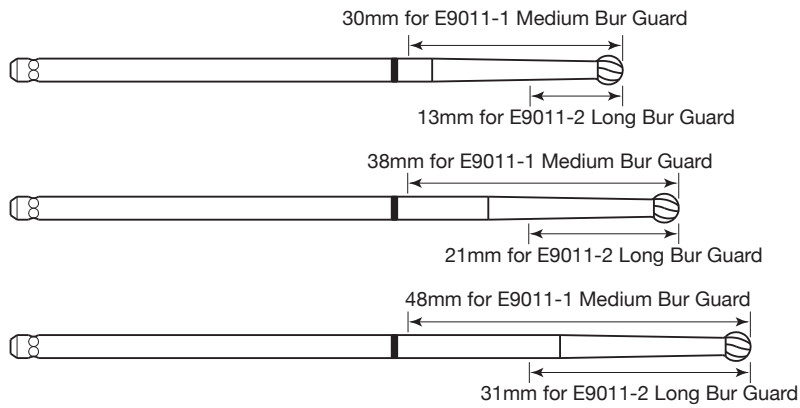

E9010 Bur Guard No.	Round Fluted						
	Flutes (mm)	4.00	4.00	6.00	6.00	6.00	8.00
E9011-1 or E9011-2	Diameter (mm)	0.50	0.70	1.00	1.50	2.00	2.50
E9011-1 or E9011-2			E8007	E8010	E8015	E8020	E8025
E9011-1 or E9011-2		E8105		E8110	E8115	E8120	E8125
E9011-1 or E9011-2		E8205	E8207	E8210	E8215	E8220	E8225

Bur Guard No.	LSO Round Fluted				
	Flutes (mm)	8.00	8.00	8.00	10.00
E9011-1 or E9011-2	Diameter (mm)	3.00	4.00	5.00	6.50
E9011-1 or E9011-2		E8030LSO	E8040LSO	E8050LSO	E8065LSO
E9011-1 or E9011-2		E8130LSO	E8140LSO	E8150LSO	E8165LSO
E9011-1 or E9011-2		E8230LSO	E8240LSO		E8265LSO

E9010 Bur Guard No.	Fine Round Diamond										
	Diameter (mm)	0.50	0.70	1.00	1.50	2.00	2.50	3.00	4.00	5.00	6.00
E9011-1 or E9011-2									E6040		
E9011-1 or E9011-2		E6105		E6110	E6115	E6120	E6125	E6130	E6140	E6150	E6160
E9011-1 or E9011-2		E6205	E6207	E6210	E6215	E6220	E6225	E6230	E6240	E6250	

E9010 Bur Guard No.	Coarse Round Diamond									
	Diameter (mm)	1.00	1.50	2.00	2.50	3.00	4.00	5.00	6.00	7.00
E9011-1 or E9011-2				E5120		E5160	E5140	E5150	E5130	E5170
E9011-1 or E9011-2		E5210	E5215	E5220	E5225	E5230	E5240	E5050		



All products may not be available in all markets.



# E Burs

Indications for Use: Otology, Spine & Neuro

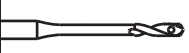

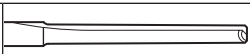

\*These burs may be used with multiple bur guard options to change the working length of the bur.

	<b>Wirepass burs</b>			
	<b>Diameter (mm)</b>	1.00	1.50	2.00
<b>E9010 Bur Guard No</b>	<b>Length (mm)</b>	38.00	38.00	38.00
E9011-1 or E9011-2		E4110	E4115	E4120

	<b>Neuro Burs</b>			
	<b>Flutes (mm)</b>	1.00	2.00	2.00
	<b>Diameter (mm)</b>	1.80	2.20	3.00
<b>E9010 Bur Guard No.</b>	<b>Bur Head Length (mm)</b>	11.00	16.00	25.00
E9011-7 or 7020-017		7021-713		
E9011-8 or 7020-018			7021-815	
7020-019				7021-917

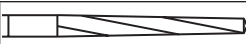
	<b>Helical Bur for E9010 Drill</b>	
<b>E9010 Bur Guard No.</b>	<b>Bur Head Length (mm)</b>	25.00
E9011-9, E9011-2 and 7020-012		7021-960

	<b>E9010 Lindemann Bur</b>	
	<b>Diameter (mm)</b>	1.60
<b>E9010 Bur Guard No.</b>	<b>Bur Head Length (mm)</b>	31.00
E9011-1		E4217

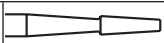
	<b>E9010 Side Cutting Burs</b>		
	<b>Diameter (mm)</b>	0.80	2.00
<b>E9010 Bur Guard No.</b>	<b>Bur Head Length (mm)</b>	4.90	7.50
E9011-1		E4208	E4220

Products shown at actual size.



**Attachments & Accessories**

	<b>Cat. No.</b>
Standard Sterilization Case .....	5052-012
Bur Rack, for Osteon™ and Ototom Burs.....	5038-009
Osteon/Ototome Bur Set, includes 16 burs (see System Listings Page 26) .....	5056-109

**Handpieces**

Osteon Handpiece, Straight.....	5038-001
Osteon Handpiece, Angled.....	5038-002

**Attachments & Accessories**

Osteon Footswitch with Hose .....	5038-004
Osteon Hose .....	5038-005
Osteon Tubing Set with irrigation tip .....	5038-600



**5052-012**



**5038-001**



**5038-002**



**5038-004**



**5038-005**













**5038-600**











All products may not be available in all markets.



# Osteon™ Burs





Indications for use: Otolaryngology









	Fluted Round Burs											
	Flutes (mm)	4.00	4.00	6.00	6.00	6.00	6.00	8.00	8.00	8.00	10.00	10.00
Working Length (mm)	Diameter (mm)	0.50	0.70	1.00	1.50	2.00	2.50	2.50	3.00	4.00	5.00	6.50
30			5056-173	5056-174	5056-177	5056-178	5056-179		5056-116	5056-119	5056-118	5056-117
38									5056-128	5056-127	5056-126	5056-125
48		5056-166	5056-165	5056-164	5056-140	5056-142		5056-149	5056-146	5056-145	5056-144	

	Fine Diamond Round Burs										
Working Length (mm)	Diameter (mm)	0.50	0.70	1.00	1.50	2.00	3.00	4.00	5.00	6.00	
30								5056-168	5056-147	5056-167	
38								5056-148	5056-150		
48		5056-161	5056-160	5056-158	5056-163	5056-162	5056-159	5056-152			

	Coarse Diamond Round Burs			
Working Length (mm)	Diameter (mm)	1.00	2.00	6.00
48		5056-958	5056-962	5056-967

	Deep Access Burs					
	Flutes (mm)	10.00	12.00	6.00		
	Diamond				Fine	Fine
Working Length (mm)	Diameter (mm)	3.00	4.00	5.50	3.00	4.00
90		5056-170	5056-171		5056-175	5056-176
95				5056-172		

	Wire Pass Burs			
	Diameter (mm)	1.00	1.50	2.00
Working Length (mm)	Bur Head Length (mm)	19.00	19.00	19.00
38		5056-184	5056-185	5056-186

	80 Grit Dermabrasion Burs				
	Diameter (mm)	4.00	7.00	12.00	10.00
Working Length (mm)	Bur Head Length (mm)	15.00	15.00	15.00	15.00
30		5056-080	5056-081	5056-082	5056-083

All products may not be available in all markets.

## Handpieces

	<b>Cat. No.</b>
Cebotome® Revision Drill Handpiece .....	5052-041

## Attachments & Accessories

Cebotome Bur Wrench.....	5052-046
Cebotome Metal Cutting Bur Wrench .....	5052-143
Standard Bur Extension, Short, use with standard Cebotome Burs .....	5052-042
Standard Bur Extension, Medium, use with standard Cebotome Burs .....	5052-048
Standard Bur Extension, Long, use with standard Cebotome Burs.....	5052-049
Metal Cutting Bur Extension, use with metal cutting wheels and diamond metal cutting burs.....	5052-142
Universal Hose, 10' (3.05m).....	5052-010

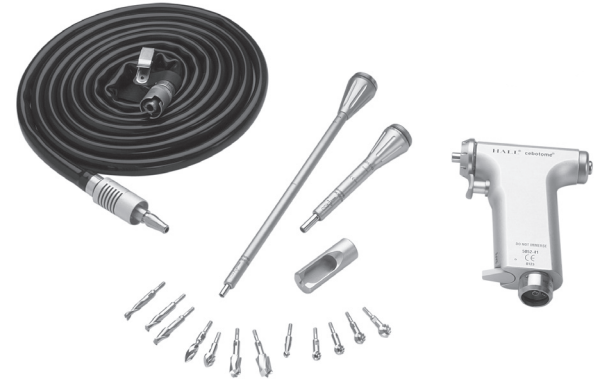

All products may not be available in all markets.

# Cebotome® Burs & Metal Cutting Accessories



Indication for Use: Large Bone Revisions Surgery

Cebotome® Burs								
Flutes (mm)	2.00	2.00	2.00	10.00	10.00	10.00	6.00	6.00
Diameter (mm)	5.00	6.00	7.00	7.00	8.00	9.00	8.50	10.00
	5052-181	5052-182	5052-183	5052-184	5052-185	5052-186	5052-187	5052-188

Cebotome Burs				
Flutes (mm)	6.00	10.00	6.00	8.00
Diameter (mm)	5.00	10.00	7.00	8.50
	5052-189	5052-190	5052-191	5052-192

Cebotome Diamond Metal Cutting Burs		
Diameter (mm)	3.2	3.2
Diamond	Flat	Round
	5052-144	5052-145

Cebotome Metal Cutting Wheels		
Grit (mm)	150.00	150.00
Diameter (mm)	25.40	25.40
	5052-125	5052-126

## C-Wires

Cat. No.	Tip	Diameter	Length	Quantity
5050-041	Spade	.028" (.70mm)	5" (13.00cm)	50 per Pkg.
5050-042	Spade	.035" (.90mm)	5" (13.00cm)	50 per Pkg.
5050-043	Spade	.045" (1.10mm)	5" (13.00cm)	50 per Pkg.
5050-044	Spade	.062" (1.60mm)	5" (13.00cm)	50 per Pkg.
5050-046	Trocar	.028" (.70mm)	5" (13.00cm)	50 per Pkg.
5050-047	Trocar	.035" (.90mm)	5" (13.00cm)	50 per Pkg.
5050-048	Trocar	.045" (1.10mm)	5" (13.00cm)	50 per Pkg.
5050-049	Trocar	.062" (1.60mm)	5" (13.00cm)	50 per Pkg.

Note: To order C-Wires in a box of 5, instead of 50 per package, please order using catalog number 5050-2XX. For example, 5051-241 instead of 5050-041.

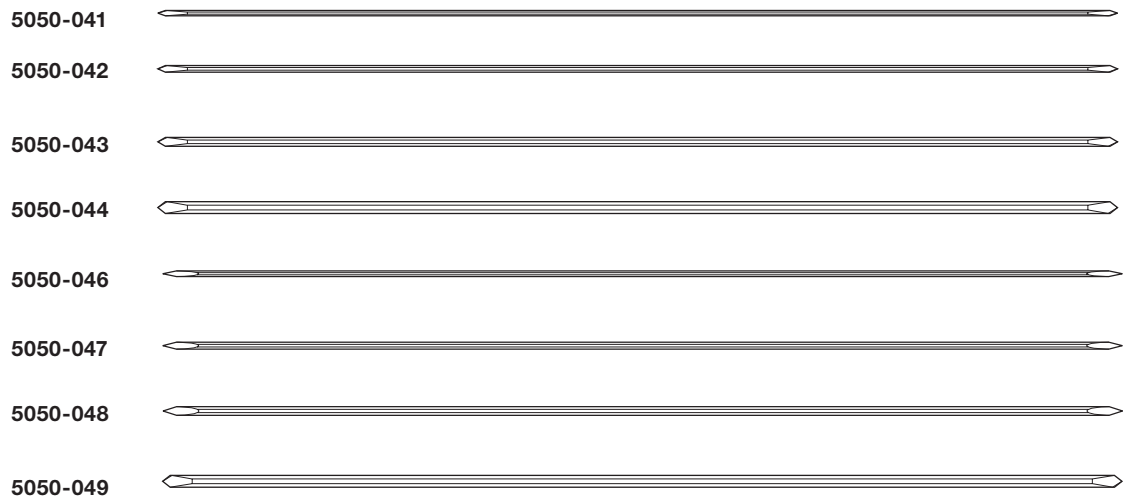

## Staplizer® Cartridges

Cat. No.	Width (mm)	Length (mm)
7707-03	7.00	7.00
7710-03	7.00	10.00
7007-03	10.00	7.00
7010-03	10.00	10.00
7015-03	10.00	15.00
7307-03	13.00	7.00
7310-03	13.00	10.00
7315-03	13.00	15.00
7320-03	13.00	20.00
7610-03	16.00	10.00
7615-03	16.00	15.00
7620-03	16.00	20.00
7625-03	16.00	25.00

Note: 3 cartridges per Pkg.  
5 Staples per cartridge.

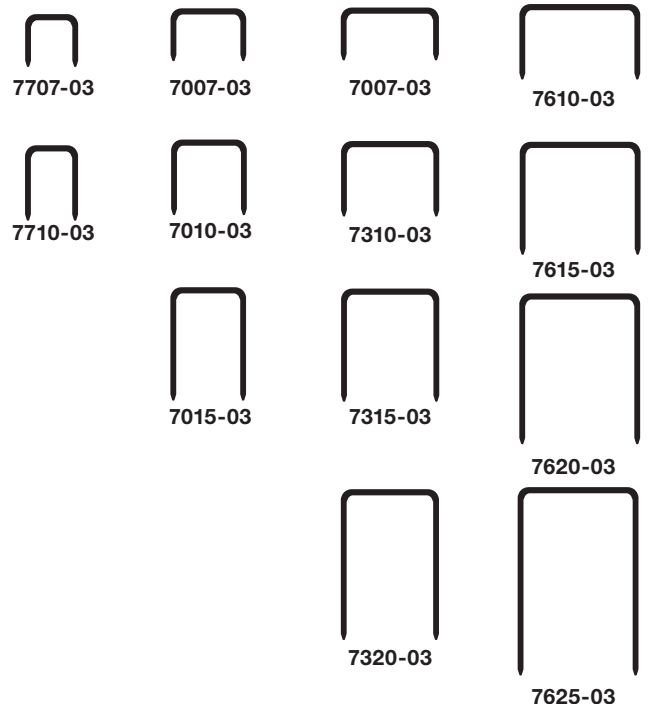

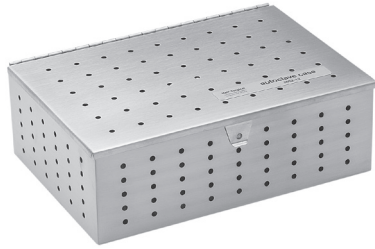

5052-012



5030-029

5030-028



1375-015



5053-124

## Sterilization Containers

Cat. No.

Standard Sterilization Case ..... 5052-012

## Holding Clamps for use with 5030-010 & 5030-020

Small ..... 5030-028

Medium..... 5030-029

Bur Cleaning Brush..... 1375-015

Cleaning Brush for Cannulated Handpieces ..... 5053-124

## Electric Consoles & Accessories

	Cat. No.
D4000 Console.....	D4000
D4000 Console with Irrigation .....	D4000A

Advantage® Console.....	D3000
-------------------------	-------

E9000® Console .....	E9000
----------------------	-------

PowerPro® Console .....	PRO2000
-------------------------	---------

Cat. No.



**D4000**



**D3000**

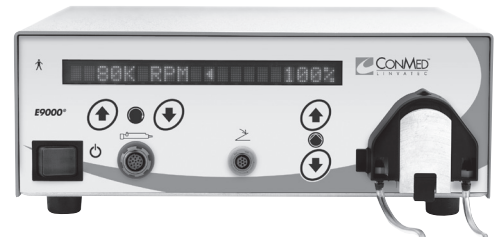

**E9000**

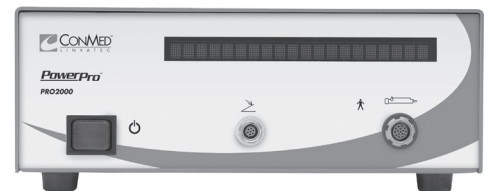

**PRO2000**

All products may not be available in all markets.



5020-053



C9863



MC5057

5039-003



5040-180

5020-054

2-Pedal Footswitch.....Cat. No. 5020-053

3-Pedal Footswitch.....C9863

Handpiece Cord.....MC5057

AC Power Cord.....5039-003

Fluid Bag Support Rod for D3000 & E9000 ..... 5040-180

Console Stand.....5020-054



Hall® offers nitrogen specific products. Please contact customer service for information.

	Cat. No.
Micro 100™ Footswitch.....	1375-028
Universal Hose, 10' (3.05m) for Hall® Handpieces .....	5052-010

Extension Hose, 10' (3.05m), Male Schrader to Female Schrader.....	5052-018
Extension Hose, 10' (3.05m), Male Diss and Female Schrader .....	5052-029
10' (3.05m) Hose for Staplizer® Handpiece .....	A201

Regulator, Single Connection.....	M207
Regulator, Dual Connection.....	M208

DISS to Schrader Adapter .....	M322
Schrader Coupler.....	5144-002

Y Connector .....	1375-040
Blitz® Instrument Cleaner (Use with Staplizer Handpiece) .....	M105A

Instrument Lubricant for Staplizer.....	M317
Hall® Lubricant for Angled Attachments .....	1365-016



**1375-028**



**5052-010**



**Extension Hose  
5052-018**



**Hose for Staplizer®  
A201**



**M207**



**M208**



**M322**



**5144-002**



**1375-040**



**M105A**



**M317**



**1365-016**

All products may not be available in all markets.

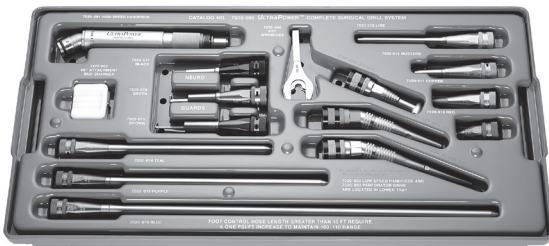

## Surgairtome Two® System

Components Ordered Separately

	Cat. No.
Surgairtome Two Handpiece .....	5058-001
Medium Bur Guard .....	1375-012
Standard Sterilization Case .....	5052-012
Universal Hose, 10' (3.05m).....	5052-010
Bur Cleaning Brush.....	1375-015

## Ultrapower® Complete Drill System Product Listing

High Speed Drill.....	7020-001
Perforator Drive .....	7020-003
Universal Hose, 10' (3.05m).....	5052-010
Short Bur Guard like Midas-X, Red.....	7020-010
Medium Bur Guard like Midas-O, Copper .....	7020-011
Long Bur Guard like Midas-M/B, Mustard .....	7020-012
X-Long Bur Guard like Midas-AM/A, Lime .....	7020-013
Short Revision Extension like Midas TU, Teal .....	7020-014
Medium Revision Extension like Midas-R, Purple .....	7020-015
Long Revision Extension like Midas RX, Blue .....	7020-016
Short Bur Guard like Midas B-5, Black .....	7020-017
Medium Bur Guard like Midas B-1, Green.....	7020-018
Long Bur Guard like Midas S-1, Brown .....	7020-019
Key Wrench, 2 per box .....	7020-040
Footswitch.....	7020-045
Storage Cabinet for Neuro Burs.....	7020-046

## Ultrapower® Neuro/Spine Drill System Product Listing

Components Ordered Separately

	<b>Cat. No.</b>
High Speed Drill.....	7020-001
Perforator Drive.....	7020-003
Universal Hose, 10' (3.05m).....	5052-010
Short Bur Guard like Midas-X, Red.....	7020-010
Medium Bur Guard like Midas-O, Copper.....	7020-011
Long Bur Guard like Midas-M/B, Mustard.....	7020-012
X-Long Bur Guard like Midas-AM/A, Lime.....	7020-013
Short Bur Guard like Midas B-5, Black.....	7020-017
Medium Bur Guard like Midas B-1, Green.....	7020-018
Long Bur Guard like Midas S-1, Brown.....	7020-019
Key Wrench, 2 per box.....	7020-040
Footswitch.....	7020-045
Storage Cabinet for Neuro Burs.....	7020-046

## Ultrapower Basic Drill System Product Listing

Components Ordered Separately

High Speed Drill.....	7020-001
Universal Hose, 10' (3.05m).....	5052-010
Short Bur Guard like Midas-X, Red.....	7020-010
Medium Bur Guard like Midas-O, Copper.....	7020-011
Long Bur Guard like Midas-M/B, Mustard.....	7020-012
X-Long Bur Guard like Midas-AM/A, Lime.....	7020-013
Short Revision Extension like Midas TU, Teal.....	7020-014
Medium Revision Extension like Midas-R, Purple.....	7020-015
Long Revision Extension like Midas RX, Blue.....	7020-016
Short Bur Guard like Midas B-5, Black.....	7020-017
Medium Bur Guard like Midas B-1, Green.....	7020-018
Long Bur Guard like Midas S-1, Brown.....	7020-019
Key Wrench, 2 per box.....	7020-040
Footswitch.....	7020-045
Storage Cabinet for Neuro Burs.....	7020-046



All products may not be available in all markets.

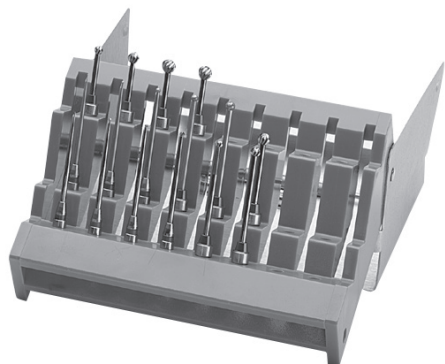

## Osteon™/Ototome Burs

Components Ordered Separately

Cat. No.

Round Carbide Bur, 6.5 x 30 mm, 2 each .....	5056-117
Round Carbide Bur, 5.0 x 30mm.....	5056-118
Round Carbide Bur, 4.0 x 30mm.....	5056-119
Round Carbide Bur, 5.0 x 38mm.....	5056-126
Round Steel Bur, 1.5 x 48mm.....	5056-140
Round Steel Bur, 2.0 x 48mm.....	5056-142
Round Carbide Bur, 4.0 x 48mm.....	5056-145
Round Carbide Bur, 3.0 x 48mm.....	5056-146
Round Diamond Bur, 4.0 x 48mm.....	5056-152
Round Diamond Bur, 1.0 x 48mm.....	5056-158
Round Diamond Bur, 3.0 x 48mm.....	5056-159
Round Diamond Bur, 0.5 x 48mm.....	5056-161
Round Diamond Bur, 2.0 x 48mm.....	5056-162
Round Steel Bur, 1.0 x 48mm.....	5056-164
Round Steel Bur, 0.5 x 48mm.....	5056-166

## Osteon Drill System with Burs

Components Ordered Separately

Bur Cleaning Brush.....	1375-015
Osteon Footswitch with Universal Hose 5052-010.....	5038-004
Osteon Hose .....	5038-005
Osteon Handpiece, Straight.....	5038-001
Osteon Handpiece, Angled.....	5038-002

## Revision Drill System

Components Ordered Separately

Universal Hose, 10' (3.05m).....	5052-010
Cebotome Revision Drill Handpiece .....	5052-041
Cebotome Bur Extension, Short.....	5052-042
Cebotome Wrench.....	5052-046
Cebotome Bur Extension, Medium.....	5052-048



## Cebotome Metal Cutting Wheel System

Components Ordered Separately

	<b>Cat. No.</b>
Cebotome Metal Cutting Wheel.....	5052-125
Cebotome Metal Trimming Wheel.....	5052-126
Cebotome Metal Cutting Wheel Wrench .....	5052-129

## Cebotome Metal Cutting Bur System

Components Ordered Separately

Cebotome Metal Cutting Bur Extension .....	5052-142
Cebotome Metal Cutting Bur Wrench .....	5052-143
ST Cebotome Metal Cutting Bur, Side, Flat.....	5052-144
ST Cebotome Metal Cutting Bur, Side, Round.....	5052-145



All products may not be available in all markets.



Hall<sup>®</sup> Powered  
Instruments System  
Product Catalog

525 French Road  
Utica, New York 13502

Local 727-392-6464  
Toll Free 1-800-237-0169

CONMED.com  
customer\_service@conmed.com

**HALL<sup>®</sup>**  
POWERED INSTRUMENTS